

Practical Computing

December 1981

Volume 4 Issue 12

Adaptive processing — the decision tree

**Reviews:
NEC PC-8001B
Piccolo
DMS for CP/M**

Using an assembler

Word-processing programs

Race night

Graphics software



WE'RE EXPANDING—
PHONE FOR JOBS



If you've already recognised the superiority of Cromemco products, or even if you're still evaluating alternative systems, it's worthwhile visiting MicroCentre.

Here's our promise. Ask to see anything in the Cromemco catalogue, and we'll demonstrate it for you. Nobody else in the UK carries a wider range of Cromemco demonstration systems and stock. We'll show you all the Cromemco computers, of course. From System Zero to System Three; the Z-2H Hard Disk system; high performance colour graphics; and the adaptable SCC single card computer.

Then we'll show you quality Cromemco peripherals; a choice of operating

systems—single user and multi-user; and a wide range of software, including compilers, data base management, word processing, and Cromemco's integrated business packages.

At MicroCentre we pride ourselves in taking care of all the important details that make up a complete service . . . like stocking the complete library of Cromemco documentation; arranging leasing and maintenance agreements; supplying continuous stationery, ribbons, floppy disks, print thimbles, etc.

So if you're interested in Cromemco systems don't miss out a visit to MicroCentre. We're Cromemco's top dealers in Europe—and proud of it!

For  Cromemco...call the experts

MicroCentre
Tel: 031-556 7354

● Circle No. 101

**LEADING UK
DISTRIBUTORS**

**Complete Micro Systems Ltd.,
30 Dundas Street
Edinburgh EH3 6JN**

Adaptive processing — the decision tree
 Reviews: NEC PC-8001B
 Piccolo DMS for CP/M
 Using an assembler
 Word-processing programs
 Race night
 Graphics software



Adaptive processing: the decision tree — page 70.

Editor
Peter Laurie

Associate Editor
Duncan Scot

Deputy Editor
Toby Wolpe

Staff Writer
Bill Bennett

Sub-editor
John Liebmann

Prestel Editor
Martin Hayman

Editorial Secretary
Julie Milligan

Consultants
 Technical **Nick Hampshire**
 Software **Mike McDonald**
 Editorial: 01-661 3500

Advertisement Manager
David Lake 01-661 3021

Advertisement Executives
Philip Kirby 01-661 3127
Ken Walford 01-661 3139

Midlands office:
David Harvett 021-356 4838

Northern office:
Geoff Aikin 061-872 8861

Advertisement Secretary
Mandy Morley

Publishing Director
Chris Hipwell

Published by IPC Electrical Electronic Press Ltd, Quadrant House, The Quadrant, Sutton, Surrey SM2 5AS. Tel: 01-661 3500. Telex/grams 892084 BIPRESSG.

Typesetting by Action Typesetters Ltd, London E17.

Printed by Eden Fisher Ltd, Southend-on-Sea.

Distributed by IPC Business Press (Sales and Distribution) Ltd, Quadrant House, The Quadrant, Sutton, Surrey SM2 5AS. Subscriptions: U.K. £10 per annum; Overseas £16 per annum; selling price in Eire subject to currency exchange fluctuations and VAT; airmail rates available on application to Subscription Manager. IPC Business Press (S & D) Ltd, Oakfield House, Perrymount Road, Haywards Heath, Sussex RH16 3DH. Tel: 0444 59188.

© IPC Business Press Ltd 1981
 ISSN 0141-5433

Would-be authors are welcome to send articles to the Editor but PC cannot undertake to return them. Payment is at £30 per published page.

Submissions should be typed or computer-printed. Handwritten material is liable to delay and error.

Every effort is made to check articles and listings but PC cannot guarantee that programs will run and can accept no responsibility for any errors.

CONTENTS

- 41 Editorial** / Welcome the big boys
 - 43 Feedback** / Recursion; bones of contention; ZX-80 Inkey routine
 - 46 Printout** / Facit's DTC series; low-cost uncommitted logic; word-processing link for CP/M systems
 - 53 Printout Extra** / The new 5.25in. Rodime hard disc
 - 55 Telesoftware** / The problems of standards for broadcasting software
 - 56 NEC PC-8001B** / The new personal computer from the giant NEC
 - 60 Piccolo** / The new system from Denmark, evaluated by Bill Bennett
 - 62 DMS on CP/M** / Compsort's Data Management System has now been re-written to run on CP/M 2.2 systems — Peter Wood reviews it
 - 67 Analysing data** / Two new sets of statistics programs are compared
 - 70 Adaptive processing** / Edward James shows how one can develop programs which will tolerate errors
 - 75 Live Wire** / Fiction by David Mentz
 - 77 Applications** / Martin Hayman looks at how the Swansea Tourist Information Centre was drawn into the world of computers
 - 80 Education** / Two programs using the principles of three-figure bearings
 - 85 Education** / A simple program to compare students' work
 - 87 Race Night** / An evening's entertainment with this game program
 - 93 12 Days of Christmas** / Join in our computerised refrain for Christmas
 - 94 Word processing** / Ian Birnbaum presents Petpro
 - 101 Word processing** / Tina Billett's word processor for the Video Genie
 - 109 Assembler** / Mike Gross Niklaus explains some of the mysteries
 - 117 Perfect answers** / The controversial Boris Allan runs through some of the more philosophical problems involved in writing bug-free programs
 - 125 Z-80 Zodiac**
 - 128 6502 Special**
 - 133 Tandy Forum**
 - 135 ZX-80/81 Line-up**
 - 141 Pet Corner**
 - 144 Micromouse**
 - 150 Puzzle**
 - 151 Book Reviews**
 - 154 Portable graphics** / Part three and a maze-making subroutine
 - 160 Apple graphics** / The second part of Roger Cullis' series
 - 167 Printers Buyers' Guide**
 - 181 The Hexadecimal Kid** / The final part of Richard Forsyth's parable
- Prestel page number 357**



PET PRINTER GRAPHICS

by COMPUTACE LTD. (NEW ADDRESS — Details below)

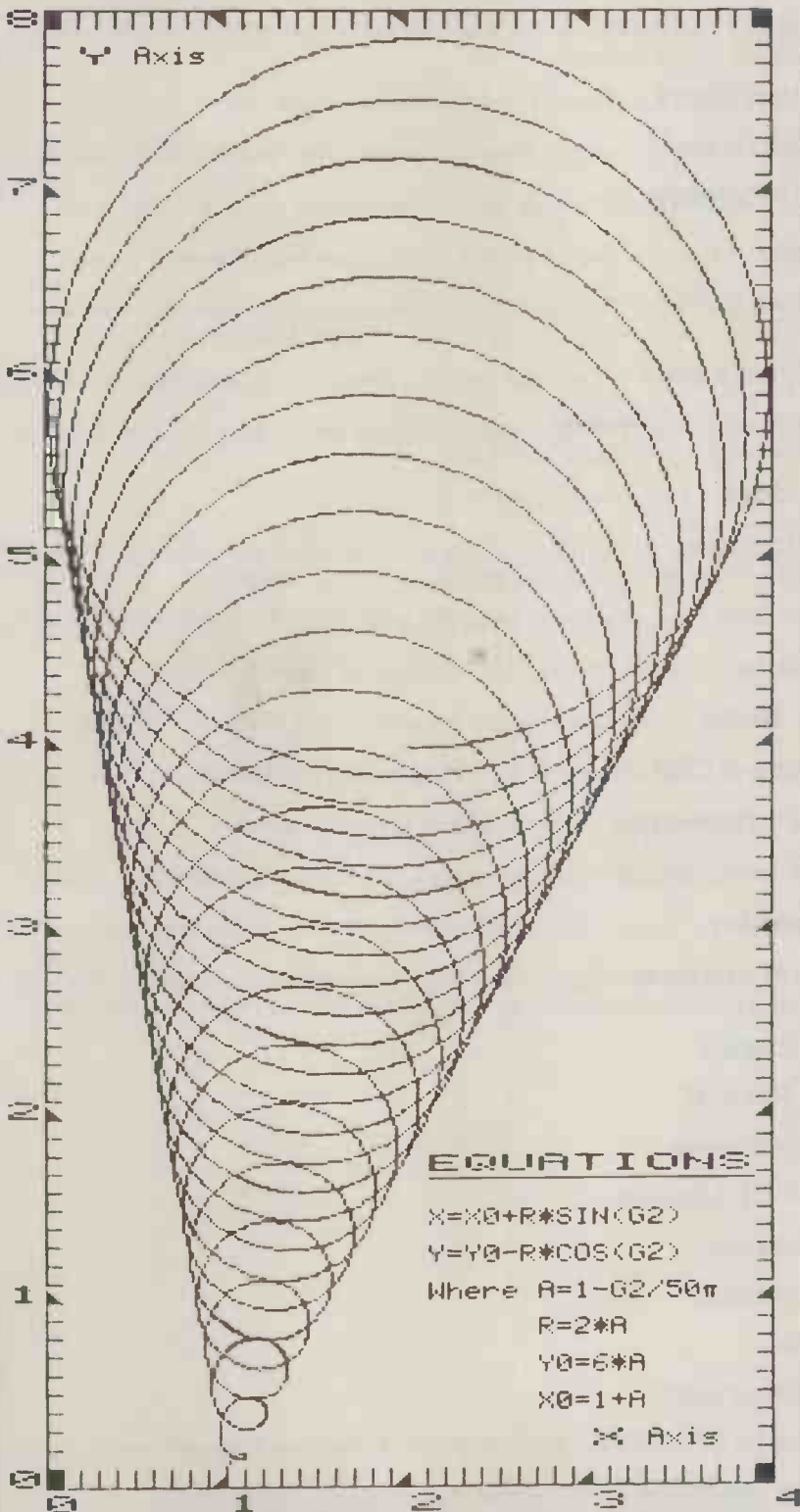

This graph is a typical example printed by AUTOGRAPH on a STANDARD COMMODORE 3022 or 4022 PRINTER. (Please specify when ordering) No disk drive or plotter required. Simple to use. Hard copy. Fully flexible graph dimensions and position on page. Automatic scale option. Variable background formats. Plots any X, Y function. Multiple graphs on same axes. Full Alphanumeric labelling for professional quality presentation:

AUTOGRAPH is supplied with extensive documentation. Send for Brochure.

AUTOGRAPH 1 (16K, 32K only) Plots any function as illus. or in spaced dots. **£39.50 incl.**

AUTOGRAPH 2 (16K, 32K only) As Autograph 1 but includes data point plot option with joining lines and marking circles. Autographs 1 and 2 combined pack. **£49.50 incl.**

CURVE FIT 1 (32 K only) Powerful Linear and Non-Linear Regression of any function to a least squares data fit. Complete with plot of regressed curve & data. **£55.50 incl.**

CURVE FIT 0 As Curve Fit 1 plus Cubic Spline Fit, Integrals and Gradients throughout. **£65.50 incl.**

Send for Brochure and details of combined packs at reduced prices.

COMPUTACE LTD., INFABCO GROUP, International Base, Greenwell Rd., East Tullis, ABERDEEN AB1 4AX

For fastest reply use:-
 COMPUTACE LTD.,
 PO BOX 50D
 NEW MALDEN, SURREY KT3 3BD

**Comart Approved
Dealers**

Aberdeen
MOM Offshore
21 Bon Accord Street
Tel: 0224 22863

Belfast
O & M Systems
95 Dublin Road
Tel: 0232 49440

Birmingham
Byteshop Computerland
94/96 Hurst Street
Tel: 021 622 7149

Bristol
Senton
27 Nicholas Street
Tel: 0272 276132

Cambridge
Toltec
24 Thompson Lane
Tel: 0223 312347

Cheshire
Holdene
82a Water Lane
Wilmslow
Tel: 0625 529486

Dublin
Lendac Data Systems
8 Dawson Street
Tel: 0001 372052

Edinburgh
Holdene Micro Systems
48 Great King Street
Tel: 031 557 4060

Glasgow
Byteshop Computerland
61 Waterloo Street
Tel: 041 221 7409

Leeds
Holdene Micro Systems
11/12 Rampart Road
Tel: 0532 459459

London
Byteshop Computerland
324 Euston Road, W1
Tel: 01-387 0505

Digitus
9 Macklin Street, WC2
Tel: 01-405 6761

Jarogate
67 Tulsemere Road, SE17
Tel: 01-670 3674

Manchester
Byteshop Computerland
Piccadilly Station Approach
Tel: 061 236 4737

NSC Computers
29 Hanging Ditch
Tel: 061 832 2269

Newbury
Newbar Computing Store
40 Bartholomew Street
Tel: 0635 30505

Nottingham
Byteshop Computerland
92a Upper Parliament Street,
NG1 6LF
Tel: 0602 40576

Sheffield
Hallam Computer Systems
451 Eccleshall Road
Tel: 0742 663125

Southampton
Xiran Systems
23 Cumberland Place
Tel: 0703 38740

Suffolk
Eurotec Consultants
Little Walsingham,
Sudbury
Tel: 0787 247959

Surrey
Gemines
184 London Road, KT2 6OU
Tel: 01-546 9944

Warwick
Business & Leisure
Microcomputers
Kenilworth
Tel: 0926 512127

Wattford
Lux Computer Services
108 The Parade,
WD11 2AW
Tel: 0923 29513

Worthing
Ace Computing Services
1-11 Bridge Road
Tel: 0903 35411

Comart Ltd,
St Neots, Cambs.
Tel (0480) 215005
Telex 32514 Comart G.

Trust Comart to turn a new ADVANTAGE

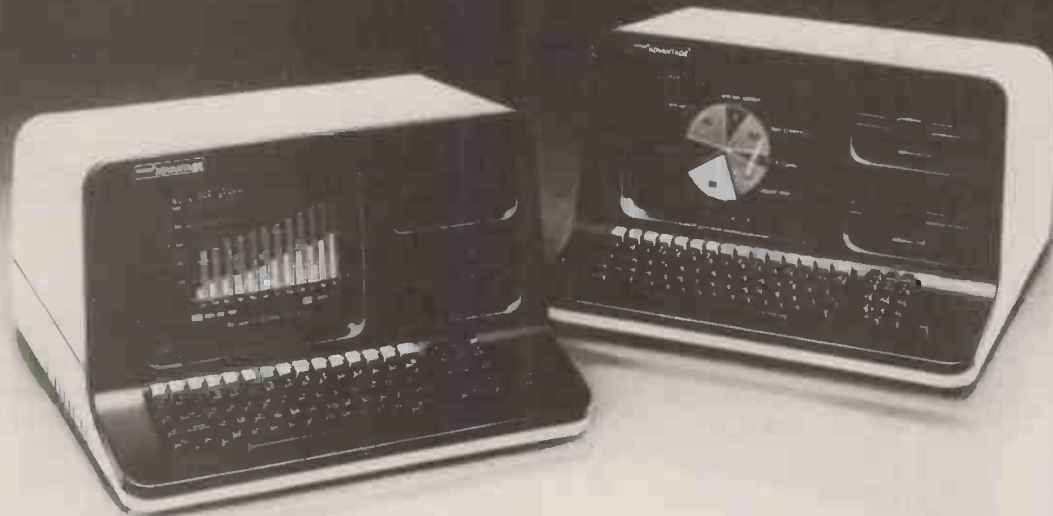

into a major benefit.

ADVANTAGE is the exciting new, packaged high performance desk top computer with integral video screen. It brings the proven reliability, so long the hallmark of NORTH STAR products, into new and broader fields of application.

Add the established Comart technical, software, and service support and the ADVANTAGE becomes a major benefit to users looking for a low cost, yet versatile, dedicated system. NOW!

Just look at the benefits.

ADVANTAGE is economical: A complete integrated accounting system and word processing system will cost around £4500 depending on the printer and software used.

ADVANTAGE is versatile: You have the benefit of application software that is already available and proven on NORTH STAR Systems.

ADVANTAGE is new: It's Business Graphics can convert data into bar charts, pie charts, graphs, and 3D representations instantly. And, what you can see on the screen, you can print.

For the technically minded, Advantage is a 4MHz, Z80A based microcomputer with 64K dynamic RAM, a 20K Byte display dedicated RAM, plus 2K Boot PROM.

An auxiliary 8035 processor provides keyboard and disk control. It has a 12" green screen, and integrated twin quad capacity 5" disk drives providing 720K Bytes of data storage. It has a 87 key Selectric[®] style keyboard with 9 control keys, 14 key numeric/cursor control pad, 15 programmable function keys, and 49 conventional character keys.

ADVANTAGE comes complete with Business graphics, self diagnostic software and graphics demo software. Its G-Basic/G-DOS, and Graphics CP/M[®] are supersets of the industry standards. They enhance ADVANTAGE'S Graphic and Character Mode capabilities, and provide a consistent operating environment for development and application programs written in any other CP/M compatible language.

To see more of the benefits of the ADVANTAGE ask your Comart Dealer, or send now for further information.

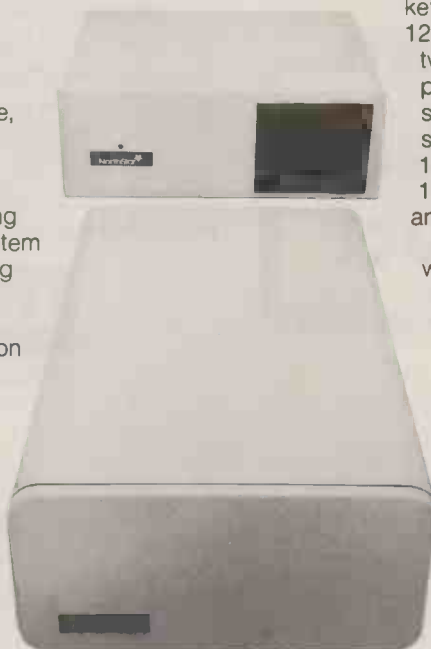

comart

SPECIALISTS IN MICROCOMPUTERS

A member of the Comart  Group of Companies.

● Circle No. 103

Nascom

.... Computing is for everyone

who chooses to use a Nascom System, be they in Education, Industry, Science or Commerce. This versatile and flexible microcomputer can be structured in whatever fashion is required to meet the needs of your particular application, with ease and simplicity. The resulting system can be expanded at will to meet growing or changing requirements.



Here is a typical computing station incorporating Nascom-2 and associated hardware, housed in a stylish plastic case complete with keyboard. In its matching case, the latest 0.7 Mbyte disc system is readily accessible.

This powerful personal computer could form the heart of the ideal small-business system and wordprocessor, or even a flexible industrial control unit.

The case can accommodate up to three Nascom-compatible extension boards giving extra memory, interface, control and/or video facilities as required. The cost of such Nascom systems range from as little as £265 to £1800 depending on complexity.

In the market place

there are many products, both hardware and software, which give your Nascom computer a more exciting working life. Indeed, this is one of the greatest benefits of the system. We have created an Approved Product Scheme intended to indicate those items you can use with confidence. These are described in our literature, available from your dealer. Look for the **nascom approved** sign.



Lucas Logic

Nascom Microcomputers
Division of Lucas Logic Limited, Warwick

Authorised Distributors:

U.K.
Anglia Computer
Norwich 29652
Bits & P.C.s
Wetherby 63774
Business & Leisure
Kenilworth 512127
CJR Microtek
Ipswich 50152
Crystal Electronics
Torquay 22699
Electrovalve
Egham 3603
Manchester 4945

Eley Electronics
Leicester 871522
Henry's Radio
London 723 1008
Holtain Ltd
Crymch 9656
Interface Components
Amersham 23307
JPS
Huntingdon 840710
Lunatronic Computers Ltd
Hereford 66174
Micro Comms
Aberdeen 63385

Micro Spares
Edinburgh 337 5611
Midshires Computer Centre
Crewe
Newcastle Comp Services
Newcastle-upon-Tyne
Off Records
London SW12 01-674 1205
Parkstone Electrics
Poole 746555
Photo Acoustics
Newport Pagnell 610625
Semicamps Northern
Kelso 73 2366

S.R.S. Microsystems
London N14 01-363 8060
Steves Electronic
Cardiff 41905
System Electronics
Brighton 26081
Target Electronics
Bristol 421196
Trading Post
Hastings 437875
Zeta Computers
Stonehouse 2444

FRANCE
JCS
Paris 265-42-62
HOLLAND
MAAS Computer Consultants
Bund 043 6411 47
GERMANY
MK-Systemtechnik
Germersheim/Rhein 07274-2756

● Circle No. 104

You've read the book You've seen the movie Now see the Systems

compec '81 stand 5218

for full details contact

RADE

**Rade Systems Ltd., 53-55 Ballards Lane, London N3 1XP
Telephone 01-349 4714 Telex 46523 Simsys G.**

● Circle No. 105



THE AUTOMATIC CHOICE

Fast 150 cps printing comes easily to hand with the Anadex 'L' series dot matrix impact printers.

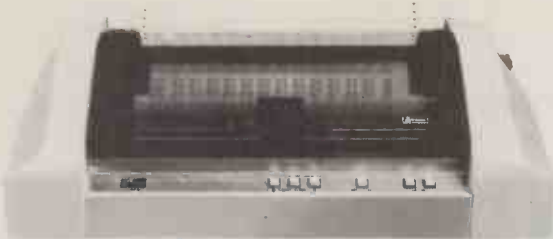

Versatile, reliable printers with the right combination of price and performance, starting at £695.00.

The DP-9000L and DP-9500L have three built-in interfaces for maximum flexibility, plus printing widths of 80/132-cols – the perfect printer for most mini and microcomputers.

Never before has Anadex offered these specifications at such a low price.

Other printers in the range include the 40-column DP-1000, 80-column DP-8000, 132/220-column DP-9501 and the 80/132-column DP-9001, most with grafixPLUS™.

Change up to Anadex, the automatic choice.

Come and see us at
Compec '81, Stand 1121

 **Anadex Ltd.**
Details from Anadex Limited, Weaver House, Station Road, Hook, Basingstoke, Hants. Tel 0256721 3401 Telex 858762 Anadex G

A1 STOCKISTS

ENGLAND: AVON Wilkes Computing Ltd Tel: 0272 290651 BERKS Riva Terminals Ltd Tel: 03447 5193 CAMBRIDGESHIRE Comart Ltd Tel: 0480 215005 DERBYSHIRE Midelectron Ltd Tel: 077 382 6811 HERTFORDSHIRE Data Efficiency Ltd Tel: 0442 63561 Data Design Techniques Tel: 01-207 1717 LANCASHIRE Keytech Eng Ltd Tel: 061 834 9244 Stack Computer Services Ltd Tel: 051 933 5511 SURREY Peripheral Hardware Ltd Tel: 01-941 4806 WILTSHIRE Kode Services Ltd Tel: 0249 813771
SCOTLAND: FIFE CS Scotland Ltd Tel: 0592 773710 MIDLOTHIAN Microcentre Ltd Tel: 031 5567354 STRATHCLYDE Robox Ltd Tel: 041 221 5402
WALES: GWENT Data Type Terminals Ltd Tel: 063 33 65307

● Circle No. 106

PRACTICAL COMPUTING December 1981

Flexibility at the heart of your system.



The RADER single board computer has been developed and tailored to offer the user a combination of economy by using the most up-to-date techniques of microprocessor technology coupled with the built in facilities of ultimate expandability and flexibility.

The board is ideally suited as the basis for small to medium business machines, games machines, industrial control machines, research and development equipment.

standard features

- 64K RAM
- 4 MHz Z80A CPU
- 5¼" or 8" Disk Interface, single/double / sided density
- Z80A CTC (clock/timer/counter)
- DMA Controller
- Memory Mapped Video Display
- Memory Mapped RAM Character Generator
- Programmable Video Controller
- 8 Expansion Connectors

- Full Custom software development support available
- Sample evaluation board £350 + VAT
- CP/M DOS available Send for complete technical specification

Rade Systems Ltd., 53-55 Ballards Lane, London N3 1XP
Telephone 01-349 4714 Telex 46523 Simsg. G.

add on option boards

- Dual Parallel Ports
- Dual Serial Ports
- Cassette Interface
- RAM Expansion Board – Capacity 192K, in 64K Increments
- External ROM Board
- User Prototyping Board
- Hard Disk Interface
- Real time clock with battery back-up

RADE
Dedicated Intelligence

● Circle No. 107

Mail Order Software

from the world's leading microsoftware supplier

Software for most popular 8080/Z80 computer disk systems including

NORTH STAR HORIZON, VECTOR MZ, OHIO SCIENTIFIC, SUPERBRAIN, Z80 APPLE, CROMEMCO, RAIR BLACK BOX, DYNABYTE, SD SYSTEMS, RESEARCH MACHINES, EXIDY SORCERER, IMSAI, HEATH, and 8" IBM formats

Software with Manual / Manual Alone

Software with Manual / Manual Alone

Software with Manual / Manual Alone

DIGITAL RESEARCH

- CP/M* FDOS — Diskette Operating System complete with Text Editor, Assembler, Debugger, File Manager and system utilities. Available for wide variety of disk systems including North Star, Helios II, Micropolis, ICOM (all systems) and Altair. Supports computers such as Sorcerer, Horizon, Cromemco, Ohio Scientific, RAIR Black Box, Research Machines, Dynabyte, etc. **from £75/£15**
- CP/M version 2 (not all formats available immediately) **£95/£15**
- CP/M for Apple II* Softcard **NEW Z80 Microsoft BASIC - 80** with high resolution graphics **£250/£15**
- MP/M **£195/£25**
- MAC — 8080 Macro Assembler. Full Intel macro definitions. Pseudo Ops include RPC, IRP, REPT, TITLE, PAGE, and MACLIB. Z-80 library included. Produces Intel absolute hex output plus symbols file for use by SID (see below) **£55/£10**
- SID — 8080 symbolic debugger. Full trace, pass count and break-point program testing system with back-trace and histogram utilities. When used with MAC, provides full symbolic display of memory labels and equated values **£45/£10**
- ZSID Includes Z80 mnemonics, requires Z80 CPU **£50/£10**
- TEX — Text formatter to create paginated, page-numbered and justified copy from source text files, directable to disk or printer **£45/£10**
- DESPOOL — Program to permit simultaneous printing of data from disk while user executes another program from the console **£30/£1**

MICROSOFT

- BASIC-80 — Disk Extended BASIC Interpreter Version 5. ANSI compatible with long variable names, WHILE/WEND, chaining, variable length file records **£155/£15**
- BASIC Compiler — Language compatible with Version 5. Microsoft interpreter and 3-10 times faster execution. Produces standard Microsoft relocatable binary output. Includes Macro-80. Also linkable to FORTRAN-80 or COBOL-80 code modules **£195/£15**
- FORTRAN 80 — ANSI '66 (except for COMPLEX) plus many extensions. Includes relocatable object compiler, linking loader, library with manager. Also includes MACRO-80 (see below) **£205/£15**
- COBOL-80 — ANSI '74 Relocatable object output. Format same as FORTRAN-80 and MACRO-80 modules. Complete ISAM, Interactive ACCEPT-DISPLAY, COPY, EXTEND **£325/£15**
- MACRO-80 — 8080/Z80 Macro Assembler. Intel and Zilog mnemonics supported. Relocatable linkable output. Loader, Library Manager and Cross Reference List utilities included **£75/£10**

- XMACRO-86 — 8086 cross assembler. All Macro and utility features of MACRO-80 package. Mnemonics slightly modified from Intel ASM86. Compatibility data sheet available **£155/£15**
- EDIT-80 — Very fast random access text editor for text with or without line numbers. Global and intra-line commands supported. File compare utility included **£45/£10**

EIDOS SYSTEMS

- KBASIC — Microsoft Disk Extended BASIC version 4.51 integrated with KISS Multi-Keyed Index Sequential and Direct Access file management as 9 additional BASIC commands. KISS included as relocatable modules linkable to FORTRAN-80, COBOL-80, and BASIC COMPILER. Specify CP/M version 1.4 or 2.x when ordering. Requires 48K CP/M **£295/£25**
- To licensed users of Microsoft BASIC-80 (MBASIC) **£215/£25**

MICROPRO

- SUPER-SORT 1 — Sort, merge, extract utility as absolute executable program or linkable module in Microsoft format. Sorts fixed or variable records with data in binary, BCD, Packed Decimal, EBCDIC, ASCII, floating, fixed point, exponential, field justified, etc. etc. Even variable number of fields per record! **£125/£15**
- SUPER-SORT II — Above available as absolute program only **£105/£15**
- SUPER-SORT III — As II without SELECT/EXCLUDE **£75/£15**
- WORD-MASTER Text Editor — In one mode has super-set of CP/M's ED commands including global searching and replacing, forward and backwards in file. In video-mode, provides full screen editor for users with serial addressable-cursor terminal **£75/£15**
- WORD-STAR — Menu driven visual word processing system for use with standard terminals. Text formatting performed on screen. Facilities for text paginate, page number, justify, center, underscore and PRINT. Edit facilities include global search and replace, read/write to other text files, block move, etc. Requires CRT terminal with addressable cursor positioning **£255/£15**
- WORD-STAR/MAIL-MERGE — As above with option for production mailing of personalised documents with mail list from Datastar or NAD **£315/£15**
- DATASTAR — Professional forms control entry and display system for key-to-disk data capture. Menu driven with built-in learning aids. Input field verification by length, mask, attribute (i.e. uppercase, lowercase, numeric, auto dup., etc.). Built-in arithmetic capabilities using keyed data, constants and derived values. Visual feedback for ease of forms design. Files compatible with all CP/M-MP/M supported languages. Requires 32K CP/M **£195/£25**

GRAFFCOM

- PAYROLL — Designed in conjunction with the spec for PAYE routines by HMI Taxes. Processes up to 250 employees on weekly or monthly basis. Can handle cash, cheque or bank transfer payments plus total tracking of all year to date figures. Prints emp master, payroll log, payslips and bank girs. Requires CBASIC-2 **£475/£35**
- COMPANY SALES — Performs sales accounting function. Controls payments of invoices and prints sales ledger and aged debtors report. Suitable for any accounting period. Comprehensive VAT control and analysis of all sales invoices. Requires CBASIC-2 **£425/£35**
- COMPANY PURCHASES — Performs purchase accounting function. Controls invoices, credit & debit notes. Prints purchase ledger, aged creditors report and payment advices. Comprehensive VAT control and analysis of all purchases. Interfaces with the ADD system. Requires CBASIC-2 **£425/£35**
- GENERAL ACCOUNTING — Produces Nominal Ledger, Trial Balance, P/L and Balance Sheet. Define your own coding system. Interactive data entry plus optional data capture from Company Sales and Company Purchases. Requires CBASIC-2 **£375/£35**
- STOCK CONTROL — Maintains stock records, monitors stock levels to ensure optimum stock holding. Details include stock desc., product code, unit, unit price, quantity on hand on order/minimum. Stock analysis reports can be weekly, monthly, quarterly etc. Interfaces with Order Entry Invoicing system. Requires CBASIC-2 **£325/£35**
- ORDER ENTRY & INVOICING — Performs order entry and invoicing function. Handles invoices for services and consumable items, part orders and part quantities. Sales Analysis report shows sales movements and trends for user-defined period Interfaces with Stock Control, ADD and Company Sales systems. Requires CBASIC-2 **£325/£35**
- ADD — Complete control of all your names & addresses including suppliers, clients, enquiries etc. Assign your own coding system and select all output via the report generator. Will print anything from mailing labels to directories. Requires CBASIC-2 **£225/£35**
- TIME RECORDING SYSTEM — Provides comprehensive control over manhour expenditures by job or account. Expense details can also be controlled. Up to 75 activities can be assigned and reports produced weekly/monthly showing movements and job account totals to date. Requires CBASIC-2 **£375/£35**
- LEASE RENTAL & HP SYSTEM — Designed to control agreements and contracts that are payable at regular intervals by fixed amounts. Handles lease, rental, HP or maintenance agreements with payments by invoice, SO, or cash. Can be used with ADD and CSS for complete credit control system. Requires CBASIC-2 **£375/£35**

Also available in bundles, contact us for details.

STRUCTURED SYSTEMS GROUP

- ANALYST** - Customised data entry and reporting system. User specifies up to 75 data items per record. Interactive data entry, retrieval and update facility makes information management easy. Sophisticated report generator provides customised reports using selected records with multiple level breakpoints for summarisation. Requires CBASIC-2. 24 x 80 CRT, printer and 48K system. **£125/£10**
- LETTERRIGHT** - Program to create edit and type letters or other documents. Has facilities to enter, display, delete and move text, with good video screen presentation. Designed to integrate with NAD for form letter mailings. Requires CBASIC-2. **£105/£15**
- NAD Name and Address selection system** - interactive mail list creation and maintenance program with output as full reports with reference data or restricted information for mail labels. Transfer system for extraction and transfer of selected records to create new files. Requires CBASIC-2. **£45/£12**
- QSORT** - Fast sort/merge program for files with fixed record length, variable field length information. Up to five ascending or descending keys. Full back-up of input files created. Parameter file created optionally with interactive program which requires CBASIC-2. Parameter file may be generated with CP/M assembler utility. **£50/£12**

SOFTWARE SYSTEMS

- CBASIC-2** Disk Extended BASIC - Non-interactive BASIC with pseudo-code compiler and runtime interpreter. Supports full file control, chaining, integer and extended precision variables etc. **£75/£10**

MICRO FOCUS

- STANDARD CIS COBOL** - ANSI '74 COBOL standard compiler fully validated by U.S. Navy tests to ANSI level 1. Supports many features to level 2 including dynamic loading of COBOL modules and a full ISAM file facility. Also, program segmentation, interactive debug and powerful interactive extensions to support protected and unprotected CRT screen formatting from COBOL programs used with any dumb terminal. **£400/£25**
- FORMS 2** - CRT screen editor. Automatically creates a query and update program of indexed files using CRT protected and unprotected screen formats. Output is COBOL data descriptions for copying into CIS COBOL programs. No programming experience needed. Output program directly compiled by CIS COBOL (standard). **£100/£12**

- APL/V80** - Concise and powerful language for application software development. Complex programming problems are reduced to simple expressions in APL. Features include up to 27K active workspace, shared variables, arrays of up to 8 dimensions, disk workspace, copy object library. The system also supports auxiliary processors for interfacing I/O ports. Requires 48K CP/M and serial APL printing terminal or CRT. **£270/£20**

- PASCAL/M** - Compiler generates P code from extended language implementation of standard PASCAL. Supports overlay structure through additional procedure calls and the SEGMENT procedure type. Provides convenient string handling capability with the added variable type STRING. Untyped files allow memory image I/O. Requires 56K CP/M. **£155/£20**
- PASCAL/Z** - Z80 native code PASCAL compiler. Produces optimised portable reentrant code. All interfacing to CP/M is through the support library. The package includes compiler companion macro assembler and source for the library. Requires 56K and Z80 CPU. Version 3 includes all of Jensen/Wirth. **£205/£15**

- PASCAL/MT** - Subset of standard PASCAL. Generates ROMable 8080 machine code. Symbolic debugger included. Supports interrupt procedures, CP/M file I/O and assembly language interface. Real variables can be BCD, software floating point, or AMD 9511 hardware floating point. Version 3 includes Sets, Enumeration and Record data types. Manual explains BASIC to PASCAL conversion. Source for the run time package requires MAC (See under Digital Research). Requires 32K. **£135/£20**
- TINY C** - interactive interpretive system for teaching structured programming techniques. Manual includes full source listings. **£45/£30**
- BDS C COMPILER** - Supports most major features of language, including Structures, Arrays, Pointers, recursive function evaluation, linkable with library to 8080 binary output. Lacks data initialization, long & float type and static & register class specifiers. Documentation includes "C" Programming Language book by Kernighan & Ritchie. **£60/£10**
- WHITESMITHS' C COMPILER** - The ultimate in systems software tools. Produces faster code than Pascal with more extensive facilities. Conforms to the full UNIX Version 7 C language, described by Kernighan and Ritchie, and makes available over 75 functions for performing I/O, string manipulation and storage allocation. Compiler output in A-Natural source. Supplied with A-Natural. Requires 60K CP/M. **£325/£20**

- ALGOL 60 Compiler** - Powerful block-structured language featuring economical run time dynamic allocation of memory. Very compact (24K total RAM) system implementing almost all Algol 60 report features plus many powerful extensions including string handling, direct disk address I/O etc. Requires Z80 CPU. **£110/£12**
- Z80 Development Package** - Consists of (1) disk file editor, with global inter and intra-line facilities; (2) Z80 relocating assembler, Zilog Mostek mnemonics, conditional assembly and cross reference table capabilities; (3) linking loader producing absolute Intel hex disk file for CP/M LOAD, DDT or SID facilities. **£50/£12**

- ZDT - Z80 Debugger** to trace, break and examine registers with standard Zilog/Mostek mnemonic disassembly displays. Facilities similar to DDT £20 when ordered with Z80. Development Package. **£30/£7**
- DISTEL** - Disk based disassembler to Intel 8080 or TDL/Xitan Z80 source code, listing and cross reference files. Intel or TDL Xitan pseudoops optional. Runs on 8080. **£35/£7**
- DISILOG** - As Distel to Zilog Mostek mnemonic files. Runs on Z80 only. **£35/£7**
- TEXTWRITER III** - Text formatter to justify and paginate letters and other documents. Special features include insertion of text during execution from other disk files or console, permitting recipe documents to be created from linked fragments on other files. Has facilities for sorted index, table of contents and footnote insertion. Ideal for contracts manuals. etc. **£75/£3**

- DATEBOOK** - Program to manage time just like an office appointment book but using the speed and memory of a computer. Keeps track of three appointment schedules (three dental chairs, three attorneys, etc.) at once. Appointments consist of name, reason for the appointment, the date and time, and the length of the appointment. System can be quickly customized for the individual user. Many helpful features for making, changing, finding, and reporting appointments. Requires 48K CP/M and 180K bytes diskette storage. Not available for Apple CP/M. **£185/£15**
- POSTMASTER** - A comprehensive package for mail list maintenance that is completely menu driven. Features included keyed record extraction and label production. A form letter program is included which provides neat letters on single sheet or continuous forms. Compatible with NAD files. Requires CBASIC-2. **£85/£10**

- XASM-68** - Non-macro cross-assembler with nested conditionals and full range of pseudo operations. Assembles from standard Motorola MC6800 mnemonics to intel hex. **£115/£15**
- XASM-85** - As XASM-68 for MOS Technology MCS-6500 series mnemonics. **£115/£15**
- XASM-48** - As XASM-68 for Intel MCS-48 and UPI-41 families. **£115/£15**
- XASM-18** - As XASM-68 for RCA 1802. **£115/£15**
- WHATSIT?** - Interactive data-base system using associative tags to retrieve information by subject. Hashing and random access used for fast response. Requires CBASIC. **£70/£15**

- XYBASIC** Interactive Process Control BASIC - Full disk BASIC features plus unique commands to handle bytes, rotate and shift, and to test and set bits. Available in integer, Extended and ROMable versions. Integer Disk or Integer ROMable. **£165/£15**
Extended Disk or Extended ROMable. **£215/£15**
- SMAL/80** Structured Macro Assembly Language - Package of powerful general purpose text macro processor and SMAL structured language compiler. SMAL is an assembler language with IF-THEN-ELSE, LOOP-REPEAT-WHILE, DO-END, BEGIN-END constructs. **£40/£10**

- SELECTOR III-C2** - Data Base Processor to create and maintain multi key data bases. Prints formatted, sorted reports with numerical summaries or mailing labels. Comes with sample applications including Sales Activity, Inventory, Payables, Receivables, Check Register, and Client/Patient Appointments, etc. Requires CBASIC Version 2. Supplied in source code. **£185/£12**
- IBM/CPM Utility Package** - has full range of functions to create or re-name an IBM 3741 volume, display directory information and edit the data set contents. Provides full file transfer facilities between 3741 volume data sets and CP/M files. **£125/£7**

- BASIC UTILITY DISK** - Consists of (1) CRUNCH-14 Compacting utility to reduce the size and increase the speed of programs in Microsoft Basic and TRS-80 Basic. (2) DPFUN - Double precision subroutines for computing nineteen transcendental functions including square root, natural log, log base 10, sin, arc sin, hyperbolic sin, hyperbolic arc sin, etc. Furnished in source on diskette and documentation. **£30/£10**

- THE STRING BIT** - Fortran character string handling. Routines to find, fill, pack, move, separate, concatenate and compare character strings. This package completely eliminates the problems associated with character string handling in FORTRAN. Supplied with source. **£30/£10**
- BSTAM** - Utility to link one computer to another also equipped with BSTAM. Allows file transfers at full data speed (no conversion to hex), with CRC block control check for very reliable error detection and automatic retry. We use it! It's great! Full wildcard expansions to send *.COM, etc. 9600 baud with wire. 300 baud with phone connection. Both ends need one. Standard and M versions can talk to one another. **£75/£5**
- BSTMS** - Intelligent terminal program for CP/M systems. Permits communication between micros and mainframes. Sends character data files to remote computers under complete control. System can record character data sent from remote computer systems and data banks. Includes programs to EXPAND and COMPRESS binary files for transmission. This software requires a knowledge of assembler language for installation. **£115/£10**

- PLINK*** - Two pass disk-to-disk linkage editor/loader which can produce re-entrant, ROMable code. Can link programs that are larger than available memory for execution targeted on another machine. Full library capabilities. Input can be PSA Relocatable Binary Module, TDL Object Module or Microsoft REL files. Output can be a COM file, Intel hex file, TDL Object Module or PSA Relocatable file. **£75/£15**
- RECLAIM** - A utility to validate media under CP/M. Program tests a diskette or hard diskette, hard disk surface for errors, reserving the imperfection, and permitting continued usage of the remainder. Essential for any hard disk. Requires CP/M version 2. **£40/£5**
- STRING/80** - Character string handling plus routines for direct CP/M BDOS calls from FORTRAN and other compatible Microsoft languages. The utility library contains routines that enable programmes to chain, copy files, retrieve command line parameters, and search for directories with full wild card facilities. Supplied as linkable modules in Microsoft format. **£50/£12**

- STRING/80** source code available separately. **£185/n/a.**
- VSORT** - Versatile sort/merge system for fixed length records with fixed or variable length fields. VSORT can be used as a stand-alone package or loaded and called as a subroutine from CBASIC-2. When used as a subroutine VSORT maximizes the use of buffer space by saving the TPA on disk and restoring it on completion of sorting. Records may be up to 255 bytes long with a maximum of 5 fields. Upper/lower case translation and numeric fields supported. **£105/£15**

- CBS** - Configurable Business System is a comprehensive set of programmes for defining custom data files and application systems without using programming language such as BASIC, FORTRAN, etc. Multiple key fields for each data file are supported. Set-up program customizes system to user's CRT and printer. Provides fast interactive data entry and retrieval with transaction processing. Report generator program does complex calculations with stored and derived data, record selection with multiple criteria, and custom formats. Sample inventory and mailing list system included. No support language required. **£185/£20**
- MAGIC WAND*** - Word processing system with simple, easy to use full screen text editor and powerful print processor. Editor has all standard editing functions including text insert and delete, global search and replace, block move and library files for boiler plate text. Print processor formatting commands include automatic margins, pagination, heading & footings, centred and justified text. Also prints with true proportional spacing, merges with data files for automatic form letters, and performs run-time conditional testing for varied output. Requires 32K CP/M and CRT terminal with addressable cursor. **£185/£20**

- T/MAKER** - Powerful new tool for preparing management reports with tabular data. Makes financial modeling projects easy. Do you want a weekly profitability report? Set up the table and compute. Just change the sales figures for next week and compute. You have a new T/MAKER includes a full screen editor for setting up tables which pages left, right, up and down. Compute includes standard arithmetic, percents, exponents, common transcendental functions, averages, maxima, minima, projections, etc. Requires 48K CP/M and CBASIC-2. **£155/£15**

Orders must specify disk type and format, e.g. North Star-Horizon single density.

Add 15% VAT to orders. Add £1 per item postage and packing

All orders must be prepaid. Make cheques POs etc payable to Lifeboat Associates.

Manual costs are deductible from subsequent software purchase

EFFECTIVE JANUARY 1981

The Software Supermarket is a trademark of Lifeboat Associates.



*CP/M and MP/M are trademarks of Digital Research
Z80 is a trademark of Zilog Inc
UNIX is a trademark of Bell Laboratories
WHATSIT? is a trademark of Computer Headware
Electric Pencil is a trademark of Michael Shriver Software
TRS 80 is a trademark of Tandy Corp
Pascal M is a trademark of Sorcim
Soft Card is a trademark of Microsoft
Apple is a trademark of Apple Computer
PLINK is a trademark of Phoenix Software Associates Ltd
MAGIC WAND is a trademark of Small Business Application Inc.

(M) Modified version available for use with CP/M as implemented on Heath and TRS 80 Model 1 computers

(L) User license agreement for this product must be signed and returned to Lifeboat Associates before shipment may be made

PC 12/81

Lifeboat Associates P.O. Box 125 London WC2H 9LU 01-836 9028/9

● Circle No. 108

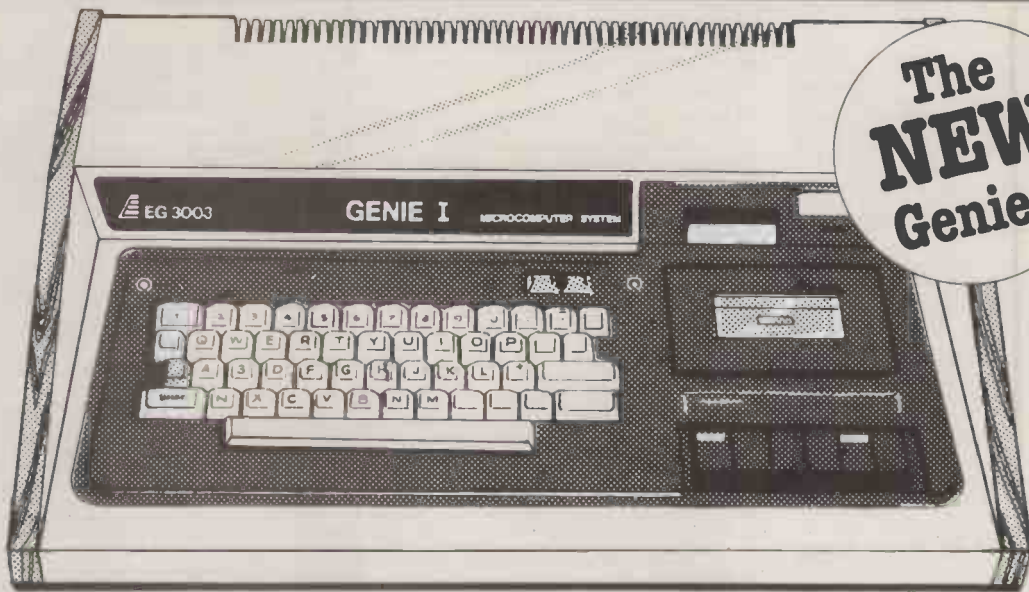

The
NEW
Genie I

ingenious!

... that's the only word to really describe the superb Genie microcomputer system, the home computer which is compatible with the TRS 80, and ideal for all micro - enthusiasts, especially the committed hobbyist.

Genie has now been upgraded to Genie I, incorporating all of the original, excellent features, but with the addition of:

- Extended BASIC, including RENUMBER and SCREEN PRINT.
- Full upper and lower case, flashing cursor and auto-repeat on all keys.
- An internal SOUND UNIT, to add a new dimension to your own programs.
- A MACHINE LANGUAGE MONITOR, with Display, modify,

enter and execute (with break points) facilities.

Genie I has all of this, plus the built-in cassette deck, 16K RAM, 12K ROM with BASIC interpreter, full-size keyboard, an extremely wide range of new and up-dated peripherals, and literally 1000's of pre-recorded programmes available.

Yet, almost unbelievably, the price of Genie I is even lower than that of the original Genie!

Ingenious for business

The Genie II is a major breakthrough for small business computers. Harnessing all the advantages of Genie I, including low price, Genie II adapts perfectly to commercial functions with the following features:

- Numeric keyboard
- Four usable, definable function keys
- Extension to BASIC
- Basic business commands
- Fully expandable with the same peripherals



TOWNE

electronics

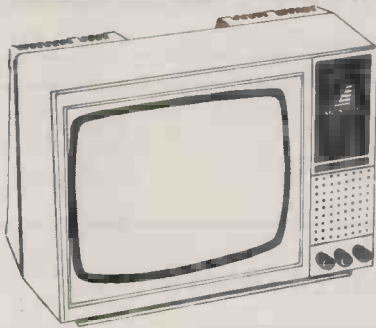

New... 12" Monitor.

There is now a choice of 2, 12" monitors with the Genie I system, allowing a clear, easy to read image, and no interference with your domestic T.V. viewing. The new EG 101 comes with an updated, green phosphor tube.

New!... Expander Box.

An updated Expansion Box (EG 3014) is a major feature of the new Genie I system, and unleashes all its possibilities, allowing for up to 4 disk drives with optional double density. It connects to a printer, or RS232 interface or S100 cards. There is 16k RAM fitted and it has a new low price!

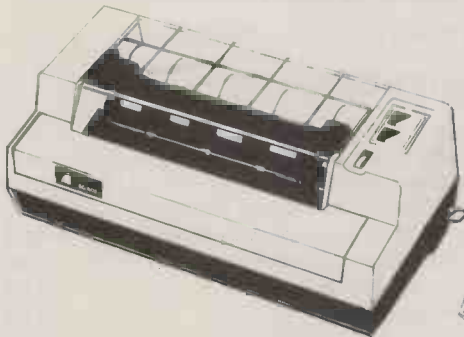

New!... Printer

The EG 602 printer can be connected to the Genie either through the expander, or directly into the computer using the Parallel printer interface. It is a compact unit, with an 80 column, 5 x 7 matrix print-out, operating quietly and efficiently at 30 characters per second.

New!... Parallel Printer Interface.

Enables you to connect the printer directly into the Genie computer without using the expansion box.

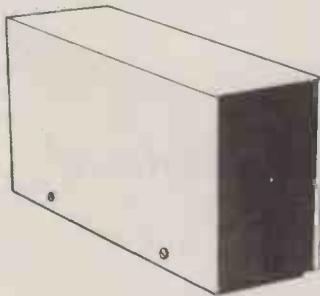

Disk Drive.

As well as the obvious advantage of mass storage, the addition of the disk system to the Genie means much faster access to other languages and full random access file handling. Up to 4 of these 40 track drives can be used on a system.

New!... Double Density Adaptor

Doubles the storage capacity of your disk drive by allowing it to work double-density.

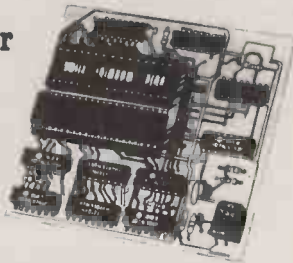

SPECIAL TECHNICAL GENIE
HOT - LINE ON 0629 4995
 for all your technical advice and service back-up on any aspect of the Genie system direct from the experts!

For full details and demonstration of Genie I, Genie II of advice on any aspect of the system, either call in to your local dealer, or write directly to the sole importers at the address below.

Genie I and II approved dealers

AVON Microstyle, Bath, 0225 334659/319705. **BEDFORD** Computopia, Leighton Buzzard, 0525 376600. **Comserve**, Bedford, 0234 216749. **BERKSHIRE** P.C.P., Reading, 0734 589249. **BIRMINGHAM** Laskys Microdigital, Birmingham, 021-632 6303. **Ward Electronics**, Birmingham, 021-554 0708. **BRISTOL** Laskys Microdigital, Bristol 0272 20421. **BUCKINGHAMSHIRE** Photo Acoustics, Newport Pagnell, 0908 610625. **Interface Components**, Amersham, 02403 22307. **CAMBRIDGESHIRE** Cambridge Micro Computers, Cambridge, 0223 314666. **CHESHIRE** Hewart Electronics, Macclesfield, 0625 22030. **Mid Shires Computer Centre**, Crewe, Laskys Microdigital, Chester, 0244 317667. **CUMBRIA** Kendal Computer Centre, Kendal, 0539 22559. **Northrock Music**, Carlisle, 0228 37114. **DERBYSHIRE** Kays Electronics, Chesterfield, 0246 31696. **T Crossley**, Chesterfield, 0246 850357. **DORSET** Blandford Computers, Blandford Forum, 0258 53737. **Parkstone Electrics**, Poole, 0202 746555. **ESSEX** Emprise, Colchester, 0206 865926. **Compuskill**, Romford, 0708 751906. **Infolab**, Chelmsford, 0245 357111. **Micro Computer Services**, Clacton on Sea, 0255 29018. **CSSC**, Ilford, 01-854 3344. **GLOUCESTERSHIRE** MPL Computers, Cheltenham, 0242 582090. **Petrie Systems**, Cheltenham, 0242 584060. **Computer Shack**, Cheltenham, 0242 584343. **Zeta Computers**, Stonehouse, 045 382 2444. **HERTFORDSHIRE** Photo Acoustics, Watford, 0923 40698. **Watford Electronics**, Watford, 0923 40568/37774. **Q Tek Systems**, Stevenage, 0438 65385. **Comp Shop**, New Barnet, 01-441 2922. **KENT** Matrix Computer Systems, Beckenham, 01-685 7508/7551. **Business Systems**, Hempstead, 0635 362652. **The Computer Room**, Tunbridge Wells, 0892 41645. **SMG Microcomputers**, Gravesend, 0474 55813. **Swanley Electronics**, Swanley, 0322 64851. **LANCASHIRE** Laskys Microdigital, Liverpool, 051-227 2535. **Mighty Micro**, Burnley, 0282 58758. **Leisurronics**, Blackpool, 0253 27590. **Harden Microsystems**, Blackpool, 0253 27590. **Micro Chip Shop**, Fleetwood, 03917 79480. **Sound Service**, Burnley, 0282 38481. **Computecat**, Leigh, 0942 605730. **Laskys Microdigital**, Preston, 0772 89264. **LEICESTERSHIRE** Eley Electronics, Leicester, 0533 871522. **Arden Data Processing**, Leicester, 0533 22255. **Kram Electronics**, Leicester, 0533 27556. **LONDON (CENTRAL)** City Microsystems, EC2, 01-588 7272/4. **LONDON (NORTH)** Radio Shack, NW6, 01-624 7174. **Comp Shop**, Edgeware Road, 01-262 0837. **Chromasonic Electronics**, N19, 01-263 9493. **Wason Microchip**, N18, 01-807 1787/2230. **Comp Shop**, New Barnet, 01-441 2922. **LONDON (WEST)** Henry's Radio, W2, 01-402 6822. **BDM Computer Marketing**, W9, 01-286 7374. **LONDON (SOUTH)** Laskys Microdigital, Kingston, 01-546 1271. **MANCHESTER** Laskys Microdigital, Manchester, 061-832 6087. **ABC Supplies**, Levenshulme, 061-431 9265. **NORTH EAST** 3 Line Computing, Hull, 0482 859169. **Derwent Radio**, Scarborough, 0723 65996. **Briers Computer Services**, Middlesborough, 0642 242017. **General Northern Microcomputers**, Hartlepool, 0783 863871. **HCCS Associates**, Gateshead, 0632 821924. **NORTHANTS** Arden Data Processing, Peterborough, 0733 49577. **NOTTINGHAMSHIRE** University Radio, Nottingham, 0602 45466. **Midland Microcomputers**, Nottingham, 0602 298281. **Laskys Microdigital**, Nottingham, 0602 415150. **Mansfield Computers**, Mansfield, 0623 31202. **East Midland Computer Services**, Arnold, 0602 267079. **Electronic Servicing Co.**, Lenton, 0602 783938. **NORFOLK** Anglia Computer Centre, Norwich, 0603 29652. **Bennetts**, Dereham, 0362 2488/9. **OXFORDSHIRE** Magnus Microcomputers, Kidlington, 08675 6703. **Micro Business Systems**, Whitley, 0993 73145. **SCOTLAND** Computer and Chips, St Andrews, 0334 72569. **Laskys Microdigital**, Edinburgh, 031-556 2814. **Scobyte Computers**, Edinburgh, 031-343 1005. **Laskys Microdigital**, Glasgow, 041-226 3348. **Esco Computing**, Glasgow, 041-204 1811. **Silicon Centre**, Edinburgh, 031-332 5277. **SHROPSHIRE** Tarrant Electronics, Newport, 0952 812134. **SOUTH AERCO** Gemsoft, Woking, 04862 22881. **Castle Electronics**, Hastings, 0424 437875. **Gamer**, Brighton, 0273 69824. **SOUTH WEST** Diskwise Ltd, Plymouth, 0782 276000. **Diskwise Ltd**, Callington, 05793 3780. **Electrosure**, Exeter, 0392 56280/56687. **West Devon Electronics**, Yelverton, 082 285 3434. **SUFFOLK** Rebuale Computers, Bury St Edmunds, 095 381 316. **Marshon Electronics**, Ipswich, 0473 75476. **Microtek**, Ipswich, 0473 50152. **Elgelec Ltd**, Ipswich, 0473 711164. **SURREY** Croydon Computer Centre, Thornton Heath, 01-689 1280. **Catronics Ltd**, Wallington, 01-667 6700/1. **SUSSEX** Nestra Electronics, Chichester, 0243 512861. **WALES** Morriston Computer Centre, Swansea, 0792 795817. **MRS Communications**, Cardiff, 0222 616936/7. **Tryfan Computers**, Bangor, 0248 52047. **WEST MIDLANDS** Allen TV Services, Stoke on Trent, 0782 616929. **Microprint**, Stoke on Trent, 0782 48346. **WILTSHIRE** Everyman Computers, Westbury, 0373 823764. **YORKSHIRE** Advance TV Services, Shipley, 0274 585333. **Amateur Radio Shop**, Huddersfield, 0484 20774. **Thomas Wright**, Bradford, 0274 663471. **Scene and Heard**, Halifax, 0422 59116. **Spot Computer Systems**, Doncaster, 0302 25119. **Superior Systems Ltd**, Sheffield, 0742 755005. **Laskys Microdigital**, Sheffield, 0742 750971. **Photo Electrics**, Sheffield, 0742 53865. **EIRE** Compshop, Dublin, Dublin 74933. **NORTHERN IRELAND** Business Electronic Equipment, Belfast, 0232 46161. **Brittain Laboratories Ltd**, Belfast, 0232 28374. **CHANNEL ISLANDS** GB Organs, St Saviour, 0534 26798/23564.

Chesterfield Road, Matlock, Derbyshire DE4 5LE
 Telephone: 0629 4995. Telex: 377482 Lowlec G.

SOFTWARE FOR CP/M COMPUTERS INCLUDING

CROMEMCO Z2D
EXCIDY SORCERER
SUPERBRAIN
VECTOR MZ
NORTH STAR HORIZON

COMART COMMUNICATOR
COMART EDUCATOR
RAIR BLACK BOX
SD SYSTEMS
NASCOM

RESEARCH MACHINES
GEMINI
TRANSAM TUSCAN
SHARP MX
8" IBM FORMATS

OTHER
FORMATS
AVAILABLE

Retailer
and OEM
terms
available

BYROM SOFTWARE

	Software & Manual	Manual Only
BSTAM—Utility to link one microcomputer to another also using BSTAM	£95	£6
BSTMS—Utility to link a micro to a mini or mainframe	£95	£11

COMPILER SYSTEMS

CBASIC v 2.08	£65	£15
---------------	-----	-----

CP/M USER LIBRARY

51 Volumes—Price per volume		
8" disc (one volume per disc)	£4	
5" disc (one volume per 2 discs)	£8	
Index	£2	

CREATIVE COMPUTING

CS-9001 BASIC Games 1	£14	
CS-9002 BASIC Games 2	£14	
CS-9003 ADVENTURE 1.0	£14	
CS-9004 BILINGUAL Original Adventure	£14	
CS-9005 BASIC Games 3	£14	
CS-9006 BASIC Games 4	£14	

DIGITAL RESEARCH

(Most formats now available)

MPM 1.1	£195	£20
MPM 2.0	TBA	
CP/M86	£160	£27
CP/M 2.2	£95	£20
CP/NET	£120	£14
SID	£50	£14
ZSID	£55	£14
MAC	£60	£14
TEX	£50	£14
DESPOOL	£33	£6
PL/1	£300	£27
BT-80	£140	£20

INFORMATION UNLIMITED

WHATSIT (Database Management System) on North Star	£65	
on CP/M	£80	
on APPLE 2:48k (requires int Basic)	£78	
on APPLE 2.32k (requires int Basic)	£65	
on ITT 2020 (see Apple)		

KLH SYSTEMS

Spooler for CPM systems v3.0	£70	£6
------------------------------	-----	----

MPI LTD.

MULTIFORTH	£72	£20
PAYROLL	£500	£15
SALES LEDGER	£200	£15
PURCHASE LEDGER	£200	£15
NOMINAL LEDGER	£200	£15
INCOMPLETE RECORDS	£1200	£20

MICAH INC.

CP/M for CDOS Users: Program to Expand CP/M system to be compatible with Cromemco CDOS software	£65	£6
--	-----	----

MICHAEL SHRAYER INC.

	Software & Manual	Manual Only
Electric Pencil Word Processor	£100	
SSII for TT Y etc	£100	
DSII for Diablo	£105	
TRS-80 Cassette/disc	£50	

MICROFOCUS

CIS COBOL version 4.4	£425	£25
FORMS 2 v1+	£100	£10

MICROLOGY

FTNUMB (FORTRAN-80 RENUMBER)	£50	£5
------------------------------	-----	----

MICROPRO INC.

WORD-MASTER 1.7A	£75	£22
TEX-WRITER 2.6	£37	£17
WORDSTAR 3.0	£250	£38
MAIL MERGE 3.0 (requires Wordstar)	£75	£10
SPELLSTAR 3.0 (requires Wordstar)	£125	£20
SUPER-SORT: Version 1	£125	£22
Version 2	£110	£22
DATASTAR 1.101	£175	£25

MICROSOFT INC.

BASIC-80 5.2	£185	
BASIC Compiler 5.3	£205	
FORTRAN-80 3.42	£260	
COBOL-80 4.01	£380	
M/SORT 1.0	£75	
EDIT-80 2.0	£65	
MACRO-80 3.42	£105	
MULISP	£105	
MUMATH 2.02	£130	

MICROTECH EXPORTS

REFORMATTER		
CPM↔IBM	£98	£17
CPM↔DEC	£98	£17

MT MICROSYSTEMS

PASCAL MT 5.2	£150	£25
PASCAL MT - 5.2 with Softbus	£265	£25
Library Sources	£110	
SOFTBUS (Speed Programming Pkge.)	£125	

NORTHSHARE

Multi-user system for Horizon Users 5.12	£44	£7
--	-----	----

OSBORNE & ASSOCIATES

ACCOUNTS PAYABLE & ACCOUNTS RECEIVABLE	£50	£15
GENERAL LEDGER	£50	£15

Full
descriptive
Catalogue:
available
£1 —
deductible
from
first
purchase

ROOM PC, 11 CAMBRIDGE HOUSE, CAMBRIDGE ROAD, BARKING, ESSEX IG11 8NT, ENGLAND
 Telephone: 01-591 6511 Telex: 892395

PHOENIX SOFTWARE ASSOCIATES (For Z80 only)

	Software & Manual	Manual Only
PLINK—Disc to disc link loader	£72	£15
PASM—Macro Assembler	£72	£15
PEDIT—Line editor with Macros	£72	£15
BUG—Very powerful debug	£72	£15
Package with all the above	£193	£33
PLINK—2 Overlay Link Loader	£185	£15

SORCIM INC. SUPERCALC

£185 £25

STRUCTURED SYSTEMS (All converted to UK Standard)

SALES LEDGER	£350	£20
PURCHASE LEDGER	£350	£20
NOMINAL LEDGER	£350	£20
STOCK CONTROL	£350	£20
LETTERRIGHT	£95	£11
ANALYST (File management Reporting System)	£125	£11
NAD (Name and Address selection system)	£55	£11
QSORT	£55	£11

SUPERSOFT INC.

DIAGNOSTICS 1	£45	£9
DIAGNOSTICS 2	£55	£9
TERM	£72	£7

TDL SOFTWARE (Technical Design Labs)

BUSINESS BASIC	£80	
ZTEL (Text Editing Lang.)	£35	
MACRO II (Z80 Macro Assembler)	£35	
LINKER	£35	
DEBUG II (for 8080/Z80)	£45	

TINY-C ASSOCIATES

Tiny-C language for 8080, 8085, Z80 systems	£55	£39
---	-----	-----

New Product
FAIRCOM INC.

MICRO B+	£145	£15
----------	------	-----

BASF DISCS

The following formats are available from stock: 8" SSSD 5 1/4" Soft Sector, 5 1/4" 10 Sectors, 5 1/4" 16 Sectors

Quantity	Price Per Disc Ex VAT
1 - 50	£2.40
51 - 100	£2.00
101 - 200	£1.80
201 - 500	£1.70
501 -	£1.50

Minimum order quantity 10 discs. Orders must be in multiples of 10. Postage, Package & Insurance 86p per 10 Discs up to 50 Discs thereafter 17p per 10. Other formats on request.

SPECIAL PRODUCT



PLINK II FEATURES

Input: TDL, PSA or MicroSoft relocatable file. The MicroSoft format file is becoming the defacto industry standard, although some other manufacturers create non-standard versions. Check with your dealer to see if the compiler you wish to use is supported.

Output: COM file, Intel .HEX file, PSA PRG file with overlays, or PSA .REL file (not allowed if MicroSoft Input). The .HEX and .REL files may be created in ASCII or binary form, and the .REL files may be used in a subsequent linkage edit if desired. Memory map: PLINK-II can create four different reports: symbols sorted alphabetically, program segments sorted alphabetically, the entire program printed in address order, and program modules printed with date and time of creation and version number (PSA .REL files only).

Common blocks: PLINK-II supports Fortran-type common blocks, with no requirement that the largest instance of the common be input first.

Memory allocation: Program modules are broken down into code, data, and common segments, regrouped into 'sections', and allocated at any memory address desired by the user. A symbol .END, is created to signify the free memory available to the program and its location may be defined at any point. Library search: Libraries of relocatable files may be loaded in their entirety, or with specific modules included or excluded. They may be searched, so that a module is included only if required by portions of the program already loaded.

Overlays: Any number of 'tree-structured' overlay areas may be created, to a depth of 32 levels, and these may be overlapped in an arbitrary fashion to create non-tree-structured organizations.

Control statements: Fifty temporary 16 bit variables are supplied. These may be assigned values, simple arithmetic and logical expressions, or console input, and may be tested via relational operators and branch instructions. Temporary variables, character strings, and simple expressions may be displayed on the console.

ORDER INFORMATION

When ordering CP/M software please specify the format you require, otherwise software will be despatched on an 8" single density disc.

All software items are subject to VAT. Manuals, when purchased separately, are not subject to VAT.

Please add £3.45 for postage, packing and insurance on each item purchased. For overseas please add £4.50 per item.

Most software in this advertisement is available from stock and a 72 hour return service is thereby offered on most prepaid orders.

These details and prices are all current as of August 1981. Our prices reflect an exchange rate of U.S. \$2.00 to £1.00. Should the exchange rate vary by more than 5 cents, a surcharge may be added or a discount given.

MAIL ORDER TELEPHONE ORDER VISIT
 Send Cash, Cheque, Postal Order, IMO, Access or Barclaycard/Visa number to Microcomputer Products International Ltd., Room PC, 11, Cambridge House, Cambridge Road, Barking, Essex IG11 8NT. All payments must be in Sterling and drawn against a U.K. bank

MAIL ORDER
 TELEPHONE
 CREDIT CARD ORDER

* VISIT *

Trade Enquiries Welcome

BRITISH GENIUS

FOR PRICE/PERFORMANCE THE BEST MICROCOMPUTER AVAILABLE



If you think (as we do) that the **SUPERBRAIN** is a good machine, we are sure you will agree that the **BRITISH GENIUS** (yes, made in the UK!) is even better, as a powerful microcomputer or as a super word-processor.

BRITISH GENIUS runs with our suite of **British Software** written to Professional Standards in **CIS/COBOL**. These cover Stock Control together with Payroll and Requirements Planning.

★ **Z80 MICROPROCESSOR** ★ **64K RAM** ★ **24 x 80 INTEGRAL VDU** ★ **BEAUTIFUL GREEN SCREEN** + true descenders, reverse video, graphics chars. ★ **SUPERB KEYBOARD** with QWERTY, numeric, cursor control, and 24 function keys. ★ **TWIN DISCS** (5in or 8in, 1 or 2 sides; capacities 350K, 700K, 1.2MB, 2.4MB). ★ **OPTION FOR 1 FLOPPY/1 WINCHESTER CONFIGURATION** (capacity 4.8MB or 9MB). ★ **RS232 SERIAL INTERFACE** ★ **CENTRONICS PARALLEL INTERFACE** ★ **OPTION FOR GPIB** general purpose interface bus for instrumentation links ★ **WCRDSTAR WORD-PROCESSING** using the CALTEXT model providing 'one-key' operation for most functions. ★ **MOST OF THE SOFTWARE ADVERTISED OPPOSITE AVAILABLE ON THE BRITISH GENIUS** ★ **COMPLETE SYSTEMS SUPPLIED** including comprehensive User Support Package. ★ **PRINTERS** — large range available plus all necessary discs and consumables. ★ **PRICES FROM £2,300** ★ **DEALER ENQUIRIES WELCOME.**

Contact:



Park Farm House
Heythrop
Chipping Norton
OXFORDSHIRE
OX7 5TW

telephone:
CHIPPING NORTON (0608) 3256
ask for: Bill Whaley
or
Bede Dunlop

PROFESSIONAL SUPERBRAIN SYSTEMS

HARDWARE

SUPERBRAINS AVAILABLE FROM STOCK

VARIOUS DISC OPTIONS (capacity 320K — 16 million bytes)
WIDE RANGE OF PRINTERS (QUME, NEC, DIABLO, SANDERS, ANADIX, DOLPHIN etc.)
HIGHLY COMPETITIVE CASH AND CARRY PRICES
OUR OWN ENGINEERING MAINTENANCE SERVICE (24hr response contracts)
HARDWARE AND SOFTWARE SUPPORT FROM THE SUPERBRAIN SPECIALISTS
DEALER ENQUIRIES WELCOME



MICRO SOLUTION APPLICATION SOFTWARE

- Integrated Accounting System£1000
- Stock Control System£450

The Accounting System includes:

- Full double-entry accounting
- Sales/Purchase/Nominal Ledgers + VAT
- Sales Invoicing
- Trial Balance/Profit & Loss
- Open Item or Balance Forward
- Up to the minute Enquiry facility
- Alphanumeric Account codes etc.

Stock Control includes:

- Order processing
- Invoice/Delivery Note printing
- Reordering and Valuation reports

- Bill of Materials£450
- Payroll Systemfrom £250

Bill of Materials includes:

- Maintenance of Assembly structures
- Multi-level Parts Explosion
- Assembly Components cost calculation
- Requirement Breakdown by period

Payroll System includes:

- Up to 15 Gross and Net pay fields
- Retention of Historical data
- Pension and Holiday pay calculation
- Special Stationery available
- Multi departments
- Up to 9999 employees

COMPILERS AND UTILITIES

- Microfocus CIS-COBOL Compiler£425
- Microfocus FORMS-2 utility£100
- Micro Solution REPORTER (CIS-COBOL Report Generator)£100
- Microsoft MBASIC interpreter£165
- Microsoft BASIC 80 compiler£200
- Microsoft COBOL 80 compiler£390
- Microsoft FORTRAN 80 compiler£260
- Microsoft MACRO 80 assembler£85
- SPELLBINDER word-processing£250

- WORDSTAR word-processing£230
- Mail Merge option for above£75
- DATASTAR data management£160
- SUPERSORT sort/merge£130
- BSTAM transfer to/from CP/M micros£75
- TTY teletype emulator (inc. vile transfer)£180
- MICROMODELLER financ. planning£645
- CBASIC compiler£75

Contact:



Park Farm House
Heythrop
Chipping Norton
OXFORDSHIRE
OX7 5TW

telephone:
CHIPPING NORTON (0608) 3256
ask for: Bill Whaley
or
Christine Airey

IMPORTANT!!! NO HARDWARE IS ANY VALUE WITHOUT THE SOFTWARE, AND OUR SOFTWARE IS UNEQUALLED. WE GIVE YOU A DISCOUNT TO SET YOU GOING. JUST DECIDE ON THE SYSTEM YOU INTEND PURCHASING, AND TAKE 10% OF ITS VALUE OFF THE PRICE YOU WOULD HAVE TO PAY FOR THE SOFTWARE. YOU COULD GET THE SOFTWARE FREE WITH THE HARDWARE IF YOU CHOSE THE BEST SYSTEM WE SELL.

SUPERBRAIN	SUPERBRAIN	COMPUSTAR	COMPUSTAR	PRINTER	PRINTER
64K + 320 K DISK	1950.00	64K MDL 10 VPU	1695.00	OKI MICRO-80	450.00
64K + 700 K DISK	2395.00	64K MDL 15 PRNT	1595.00	OKI MICRO-83	795.00
64K + 6.3 M DISK	4595.00	64K MDL 20 VPU	2495.00	EPSON MX80F/T	450.00
EMULATOR TERML	495.00	64K MDL 30 VPU	2795.00	TEXAS 810	1395.00
INTERTUBE III TML	495.00	64K 5 MB VPU	4895.00	DIABLO 630	1595.00
5.7 MG CORVUS DSK	2250.00	10 MEG INTERTEC	3250.00	NEC 5530	1595.00
11 MEG CORVUS	3250.00	32 MED INTERTEC	7950.00	NEC 5510	1695.00
CORDLESS PHONES	135.00	96 MEG INTERTEC	8500.00	NEC 5525	1895.00
HIGH RES S/B GRAPH	750.00	BUS PROGRAMS	975.00	QUME 5/55	2195.00
TRACTORS	150.00	BUS MANUAL	25.00	DBMS2	575.00
SHUGART 5 MEG DSK	1250.00	S100 CONTROLLER	750.00	CP.M (TM)	FREE

SYSTEM 1	1950.00	SYSTEM 2	4595.00	SYSTEM 3	2750.00
64K + 750 K DISK CRT AND S100 BUS IN 1 'ARCHIVES' UNIT		64K + 7.3 MEGABYTE CORVUS MICRO-WINCHESTER & CRT IN 1 'SUPERBRAIN' UNIT		64K + 1.5 MEG CRT AND TWIN 5" IN COMPUSTAR UNIT	

MBASIC 80	150.00	FORTRAN-80	200.00	COBOL-80	320.00
CIS COBOL	420.00	PAŞCAL UCSD	475.00	WORD-STAR	250.00
MAIL MERGE	55.00	SUPER SORT	120.00	CBASIC	75.00
DATASTAR	190.00	BASCOMPILER	190.00	MAGIC WAND	190.00
DBMS (DATABASE)	475.00	SUPER CALC (CPM)	155.00	T/MAKER	150.00
DBMS (EXTENDED)	575.00	BUS VER 8.00	975.00	BUS VER 9.00	1075.00
MSORT & DSORT	75.00	LETTERRIGHT	100.00	UTILITES	75.00

OUR PRICE INCLUDES FREE
TRAINING SESSION
CABLES
EXTENDED WARRANTY IF REQD
CPM HANDBOOK

10% ALLOWANCES AGAINST
DELIVERY
6/12 MTH WARRANTY
RIBBONS & THIMBLES
BASIC MANUAL

ANY SOFTWARE ABOVE
5-50 DISKS
24/48 HOUR REPAIR
MANUALS
2,000 SHEETS PAPER

IF YOU WISH TO MAKE THE WARRANTY TO 1 YEAR THEN ADD 5% OF HARDWARE COST. OTHERWISE NO MAINTENANCE SCHEDULE, SIMPLY ADD-HOC CHARGES AFTER WARRANTY EXPIRATION, SAME QUALITY SERVICE. (SITE MAINTENANCE ON APPLICATION)

MAIL ADDRESS G.W. COMPUTERS LTD., 55 BEDFORD COURT MANS., BEDFORD AVENUE, WC1
LONDON TELEX 892031 TWC G. BOSTON OFFICE TELEX 94-0890

DUE TO LONG TERM CONTRACTUAL COMMITMENTS, WE ARE ONLY GIVING RESTRICTED DEMONSTRATIONS BY APPOINTMENT AT ONE OF OUR LONDON OFFICES. WE EXPORT TO ALL COUNTRIES, AND TAKE AMEXCO, BARCLAYCARD AND ACCESS. CONTACT TONY WINTER ON 01-636 8210 OR 01-631 4818 AND IF UNAVAILABLE THEN LEAVE A CALL-BACK MESSAGE (CLEARLY STATING YOUR TELEPHONE NUMBER AND NAME) ON THE 24-HOUR ANSWER-PHONE, WE CALL BACK ANYWHERE IN THE WORLD. OR SIMPLY LEAVE YOUR ADDRESS, AND WE'LL MAIL YOU A STANDARD INFORMATION PACK. MAIL ADDRESS, 55 BEDFORD COURT MANSIONS, BEDFORD AVENUE, LONDON WC1.

***** ALL YOU NEED FROM A COMPUTER SYSTEM *****
DATABASE MANAGEMENT + WORD-PROCESSING + MODELLING + DIY INTERPRETER + SERVICE

TWO TYPICAL PACKAGE DEALS

NORMALLY

NORMALLY

01 — SUPERBRAIN 64K RAM 320 K	1950.00
02 — EPSON MX80FT (OR SIMILAR)	475.00
03 — CABLE	25.00
04 — 12 MONTH WARRANTY	235.00
05 — DELIVERY IN U.K.	40.00
06 — TRAINING SESSION	50.00
07 — CP/M HANDBOOK	8.75
08 — 50 BASIC EXERCISES	8.75
09 — BOX PAPER (2000 SHEETS)	20.00
10 — DBMS2 (DATABASE)	575.00
11 — MAGIC WAND	190.00
12 — MBASIC-80	150.00
13 — SUPER CALC	150.00
14 — 40 MEMOREX DISKETTES	114.00
15 — DOS + AND DIAGNOSTICS	125.00
16 — MSORT & DSORT	75.00
17 — RECOVER + AUTOLOAD	25.00
18 — INSTANT BASIC	9.00
(NOT INC VAT)	4225.50
OUR PRICE	2995.00

01 — SUPERBRAIN 64K RAM 700K	2395.00
02 — NEC 5510 (OR SIMILAR)	1695.00
03 — CABLE ADAPTER	25.00
04 — 12 MONTH WARRANTY	410.00
05 — DELIVERY IN U.K.	50.00
06 — TRAINING SESSION	50.00
07 — CPM HANDBOOK	8.75
08 — 50 BASIC EXERCISES	8.75
09 — BOX PAPER (2000 SHEETS)	20.00
10 — DBMS2 (DATABASE)	575.00
11 — MAGIC WAND	190.00
12 — MBASIC-80	150.00
13 — SUPER CALC	150.00
14 — 25 DYSAN D/SIDE DISKETTES	150.00
15 — DOS + AND DIAGNOSTICS	125.00
16 — MSORT & DSORT	75.00
17 — RECOVER + AUTOLOAD	25.00
18 — INSTANT BASIC	9.00
(NOT INC VAT)	6220.50
OUR PRICE	4950.00

EXTRA SPECIAL SUPERBRAIN PROGRAM MAIL ORDER OFFER OF THE 5 MAIN PROGRAMS DBMS2 + SORTS + MAGIC WAND + MBASIC-80 + SUPER CALC NORMALLY 1140 POUNDS **OUR PRICE 595.00 + VAT**

WARRANTY NOTE: WE HANDLE ALL REPAIRS OURSELVES.

WARRANTY COVERS FREE REPLACEMENT EQUIPMENT IF DEFECTIVE IN FIRST THREE WEEKS. THEREAFTER UP TO 12 MONTHS THE COVER PROVIDES INSURANCE ON ALL SPARE PARTS AND LABOUR COSTS (EXCLUDING CARRIAGE).

CALL OUT MAINTENANCE IS ALSO AVAILABLE AT 25.00 MINIMUM (LONDON) 50.00 MINIMUM ELSEWHERE IN U.K. PLUS MILEAGE.

***** BUS *****
(BUSINESS EFFICIENCY)

WIDELY USED IN U.K./FRANCE/U.S.A. AND ENGLISH SPEAKING COUNTRIES FOR ITS OVERALL FLEXIBILITY AS A COMPLETE BUSINESS PACKAGE.

INCLUDES INVENTORY, DATABASE MANAGEMENT, INVOICING, MAILING ADDRESSES, STATEMENTS, SALES/PURCHASE LEDGER WITH OR WITHOUT AUTO STOCK UPDATE AND DOUBLE ENTRY JOURNALS INCLUDING NOMINAL LEDGER; PLUS A/C RECEIVABLE AND PAYABLE MAKING AUTO BANK ENTRIES.

- | | |
|------------------------------|----------------------------|
| 01 = NAMES AND ADDRESSES | 13 = STATEMENTS |
| 02 = STOCK CONTROL | 14 = TAX REPORTS |
| 03 = OPEN SALES LEDGER | 15 = AGED ANALYSIS |
| 04 = OPEN PURCHASE LEDGER | 16 = MANAGEMENT ANALYSIS |
| 05 = GENERAL SALES LEDGER | 17 = CASHFLOW FORECAST |
| 06 = GENERAL PURCHASE LEDGER | 18 = PARAMETER SECTION |
| 07 = BANK UPDATE | 19 = DIARY REMINDER |
| 08 = USER DATABASE AREA | 20 = COMPUTE FUNCTIONS (+) |
| 09 = INVOICE CREATION | 21 = FILE MAINTENANCE |
| 10 = ORDER FILES | 22 = CALL OTHER PROGRAMS |
| 11 = TEXT FILES | 23 = AUTOMATIC DRIVE (+) |
| 12 = EMPLOYEE FILES | 24 = DISK SWAP/EXIT SYSTEM |

WHICH OPTION (LEVEL 8.00 @ 975.00)
 (LEVEL 9.00 @ 1075.00)

- SUB-MENU EXAMPLES:
 >Quit or .Random or .Sequential or .Key sorted field or .Other functions
 >Quit or .All or .Part of .Specific
 >Quit or .Fast screen or .Slow screen or .Rapid print or .Pausing print
 >Quit or .Continue or .Amend or .Delete or .Print
 >Quit or .Double entry or .Alter filename or .Echo input or .Print options
 >Quit or .Mail ticket or .Columnated or .Raw data line
 >Quit or .Add or .Subtract or .Multiply or .Divide
 >Quit or .Greater or .Smaller or .Cross refer two files

+++++ SUPER — BUS + + + + + A NEW HIGHER LEVEL OF THE ABOVE PACKAGE ... HAS BEEN REDUCED IN SIZE BY 50 PER CENT TO A SINGLE 15K BASIC PROGRAM, MAKING ALL FILE RETRIEVALS A MATTER OF NANoseconds. WORKS UNDER M/PM AND COMPUSTAR FOR COMMON DATA RETRIEVAL LEVEL 10.00. 1475.00 ****

DBMS (DATABASE) HAS 01=; 02=; 04=; 06=; 07=; 08=; 17=; 18=; 21=; 24=. PRICE 475.00

DATABASE FEATURES ARE: FOR ANY SIZE RECORD UP TO TWENTY FOUR FIELDS FILE ARCHITECTURES CAN BE DESIGNED WITH COMPLETE FREEDOM OVER THE LINGUISTIC CONVENTIONS ASSIGNED TO EACH FIELD. THE FILE THEN CAN STORE 32000 RECORDS WHICH CAN BE SEARCHED BY THE RANDOM ACCESS NUMBER (RETRIEVED IN LESS THAN ONE SECOND) OR 'KEY' RANDOM ACCESS ON SPECIFIED FIELD OR SEQUENTIALLY COMPARING FOR LEFT FIELD PARTS, FIELD-INKEYS, OR PARTS OF RECORD, AND THEN CHANGED, PRINTED, DELETED, SKIPPED.

GRAMA (WINTER) LTD/G.W. COMPUTERS LTD. ARE THE PRODUCERS OF THIS PACKAGE WHICH IS UNEQUALLED FOR ITS LEVEL OF TOTAL INTEGRATION, LINGUISTIC FLEXIBILITY AND MAXIMISED DISK/MEMORY CONSERVATION.
 AUTHOR TONY WINTER (M.D.;B.A.LIT;B.A.HON.PHIL; AND LECTURER)

CALLERS ONLY BY APPOINTMENT AT ONE OF OUR LONDON OFFICES. TELS 01.636.8210 AND 01.631.4818 (TONY WINTER)

***** MULTIPLE FIELD ATTRIBUTES *****
dbms2 and bus10.00

The following is a list of the field attribute arithmetic functions that may be set up against up to 16 fields per record and found to be both complex and of considerable power.

fn1 = Multiply one field against another and total per record/file.

fn2 = Add one field against another and total per record/file.

fn3 = Divide one field from another and total per record/file.

fn4 = Subtract one field by another and total per record/file.

fn5 = Total vertical columns within a file of records.

The result per record and per file.

fn6 = Calculate a percentage of the value of one field and if the toggle is set to 1 then add that result to the field; whereas if the toggle is set to -1 then simply store the result.

Example:

Field 01 = number	(5)		record.5	computed values
Field 02 = code	{MICRO	}	record	file
Field 03 = quantity	(50)			
Field 04 = s. price	(1000.00	}	[50,000.00]	[70,000.00]
Field 05 = profit	(250.00	}	[150.00]	[170.00]
Field 06 = cost	(800.00	}	[.25]	[.27]
Field 07 = allocated	(20)	}	[1,000.00]	[1,145.00]
			[30.00]	[450.00]

The two results to the right of the record show the use of several of the functions listed above.

Field 03 function 1 (03 * 04) has a value of 50,000.00 pounds worth of 'MICROS' for the number '5' and 70,000.00 pounds worth of for all such records so far scanned.

Field 04 function 6 'toggle -1' (04 * .15) has the increase that is required to raise the price of record '5' by 15%, and so on averaging for all such records.

Field 05 function 3 (05 / 04) has the value of itself divided by the value found in field 04, for the record and all such records scanned. (profit margin ?).

Field 06 function 6 'toggle 1' (06 * 1.25) has the value of record '5' as if it were subject to an increase of 25%, and all such records scanned.

Field 07 function 4 (03 - 07) has the quantity remaining in stock after allocations are subtracted.

You have a combination of *multiple field searches* of 5 TYPES and *multiple compute functions* of 10 TYPES against up to 16 fields, using words you choose and printing only those columns in the order you desire in one SINGLE CORE PROGRAM.

***** MULTIPLE FIELD SEARCHES *****
dbms2 and bus10.00

The following trajectory of a file interrogation may be set up and found to be both complex and of considerable power.

Try a **Sequential search** that is **Slow** and on **Multiple fields** within a range say of record '1 to 30'.

Notice that the cursor prompter will move to the first field in the record form. You will be able to ask any of the following types of questions on each field. When you set the question against that field; if the carriage return is not enabled by the fact that you hit the right-hand-field-bracket, then hit (cr).

There are five types of questions you may ask against a permutation of up to sixteen fields. (Think about them).

1 = straight text identity (p = p) which is to say that you can enter TONY in a name search where the record may look like TONY WINTER or WINTER TONY. the 'TONY' text is sought for in any part of the field.

= **Greater than identity (P > Q)** which is to say that you may first enter the symbol > followed by a numeric value (say 100) where the records may possess different ranges of numbers in that field, and you only want 100 upwards.

3 = Smaller than identity (P < Q) as '2=' above in reverse using X

4 = Not identical (P < > Q) which is to say that all records found on other criteria must not possess the stated attribute. (ie: all records with TONY but not in W.C.1.). You must first enter the symbol ~ followed by the criteria that is to be excluded from the comparison.

5 = Either or identity (P ^ Q) which is to say that you may search for either TONY or someone in W.C. 1. or telephones with a 01 in their number. **Note:** that only one match of those disjunctive premises is sufficient to provide the truth condition establishing a match. That is to say you may find records of TONY in Birmingham and FRED in W.C.1. You must first enter the symbol ^ followed by the text. A multiple example is shown below.

Field 01 = number	{ ()	}	The question is?
Field 02 = name	{ TONY	}	straight text (cr)
Field 03 = postcode	{ ^ W.C.1.	}	one of
Field 04 = town	{ ^ London	}	other
Field 05 = income	{ > 5000	}	greater 5000
Field 06 = age	{ < 40	}	younger than 40
Field 07 = sex	{ -female	}	not female

If you are interested enough to study this section of our new manual, then you are probably in need of a program embodying such features. If you understand the text, that is, if at least its meaning is a *touchstone* that fires your imagination towards *grasping* it with the mind then you and it are converging.

contact:

G. W. COMPUTERS LTD. 55 BEDFORD COURT MANSIONS, BEDFORD AVENUE, LONDON W.C.1.
TEL 01-636 8210. TEL 01-631 4818. TELEX 892031 TWC G

Also incorporated in Boston U.S.A.

BUS PROGRAM MANUAL VERSION 8.00-10.00 AND DBMS (SUBSET OF ABOVE)

AUTHOR: TONY WINTER B.A.LIT: B.A.HON. PHIL. AND LECTURER

The best diskette for your system

- * All IBM formats
- * AES/Lanier
- * Apple II
- * Atari
- * CPT 8000
- * Diamond

Dysan

DISKETTES — AND DISC PACKS

- * Nexos 2200
- * P2000
- * P5002/Micom
- * Wang
- * Zenith
- * — among others

We keep stocks of 30,000 for immediate
delivery to dp and wp users

FOR YOUR RECORDS THE DYSAN HOTLINE IS: 0252 517171

HAL Computers Limited
Invincible Road, Farnborough
Hants. GU14 7QU.
Telephone 0252 517171



● Circle No. 115

VECTOR PLOTTING, MICRO PRICE

Real vector plotting from only £690* with the new Strobe Model 100 drum-type plotter. * High resolution — 0.1mm at 7.6cm/sec * A4 paper capacity * Off-the-shelf felt tip pens plot in most colours * Precise operator controls and interactive input of coordinates * Hardware interfaces for TRS-80, Apple II, Pet, S-100 * Applications software packages providing vector plotting and variable size alphanumerics for TRS-80 Level II BASIC, Applesoft BASIC, North Star BASIC, C BASIC, Microsoft BASIC and FORTRAN.

Telephone Weybridge 4834617 for free brochure and more details.

*Unit price for plotter ex-delivery and ex-VAT.

HAL Computers Limited
Invincible Road, Farnborough
Hants. GU14 7QU.
Telephone 0252 517171



● Circle No. 116

LOOKING FOR 5 1/4

EP4000 EPROM Programmer/Emulator — Not just a programmer.

Programs a wide range of EPROMs without personality cards. Video output for editing and LED display for stand alone operation. Standard interfaces include RS232C, 20mA, TTL, cassette, printer and DMA. In EMULATION MODE EP4000 replaces your in-circuit PROMs for program development and makes changes, entries, edits simple. Accessories include Bipolar programming modules, multi EPROM simulator adaptors, buffer pods, ERASERS, Monitors, 2764/2564 programming satellite, printer and production gang programmers.

EP4000 programmer/simulator £545.00 P4000 production programmer £545.00 (9 sockets) Eraser £78.00 Monitor £88.00 Printer £395.00

Microtek MT80

Probably the most reliable small matrix printer. To coincide with the move into our new factory we are offering these at clearance prices. 9 x 7 matrix. upper and lower case — one only ARABIC — , extended print, 40,80,132 column. 125 CHARACTERS PER SECOND.

Parallel MT80P £395.00 Serial MT80S £445.00

Cables available for all of the popular micros.

DYSAN DISKETTES. Indisputably the best you can buy.

30,000 diskettes in stock. As well as the standard range of diskettes for Apple, PET, TRS-80, etc, we also supply pre-formatted for: CPT 8000, Micom/PS002, all IBM, AES/Lanier, Atari, Nexos 2200, Wang, Zenith and P2000. For immediate delivery call our HOTLINE... Weybridge 48346/7

The Revolutionary New 8" Thinline

Tandon's revolutionary new 8 inch floppy disc drive is only half the thickness of earlier drives so that you can pack twice the storage into the same space. In addition a new method of construction allows the drive to constantly compensate for changes in temperature and humidity so that real capacities of up to 4.M.bytes are now achievable in the usual 8 inch floppy disc drive envelope size. The TM800 series drives require only D.C. power (5v and 24v) so that they run cool and no changing of pulleys and belts is needed for manufacturers who want to ship products abroad.

Our new low profile packaging, designed and built in the U.K., complete with power supplies makes incorporation into, or addition to, existing systems simple.

APPLE II & TRS-80 COMPATIBLE MINI FLOPPIES

This is our popular TM 100 series mini floppy... Tandon make 40,000 of these a month. Available as bare drives and packaged in single and dual cabinets with power supplies. Capacities from 100K.bytes to 1 Mbyte per drive! Compatible with TRS-80, Video Genie, SUPERBRAIN, Horizon, Zenith, SWTP, Heathkit etc., and supplied as the standard drive with many of these systems.

TRS-80 compatible (in cabinet with power supply)	DUAL UNITS	40 track	£399.00
		80 track	£549.00
	SINGLE UNITS	40 track	£219.00
		80 track	£289.00
APPLE II Compatible	Single disc	£249.00	
	Dual disc	£488.00	
APPLE Controller board	DOS 3.3	£POA	

Prices exclude VAT and delivery charges.

SPARE PARTS SERVICE AND TRAINING

We carry a complete stock of emergency spare parts for Tandon disc drives and we can fix any drive on a short turn-round. All final testing is carried out on an in-house ATE drive testing system which can run 73 separate diagnostic programs to ensure that your drive leaves us in absolutely first class condition. A less complex calibration service is also available. Full product support exists for genuine OEM customers and we run single day training courses at regular intervals. Call our service engineering department for further information.

We carry the full range of Dysan alignment diskettes and a staff of Sales Engineers will be pleased to help you with any queries.



HAL Computers Limited
Invincible Road, Farnborough
Hants. GU14 7QU.
Telephone 0252 517171

WINCHESTERS?

I've got just what
you're looking for....

Our new Micro Winchester gives you from 5 to 20 M.bytes of hard disc storage from as little as £1425.00 for a complete ready-to-go, plug-in system with software.

Floppies and larger more expensive hard discs are no match for our new drives which pack enough data to run serious business or technical applications software into a mini-floppy size 5¼" unit. Your data is protected in the sealed enclosure making diskette handling problems a thing of the past. The disc is fast — 40 times faster transfer rate than a mini-floppy — yet fits into the same space and so can be used as a replacement or an enhancement.

Controllerability

Our controller comes with a range of adaptors to plug on to most popular micros and there are more adaptors on the way. It supports two discs with ease and while others are struggling with less stable analog data separators and speed-eating error correction circuits, we use a high performance digital design which literally locks into the data stream and stays there. Incidentally we also sell digital data separator cards to OEMs. Real time and multi-tasking applications benefit from the controller's interrupt capability and macro level command structure and the OEM version features a simple software interface and CP/M 2.2 BIOS with extensive development aids. The software comes on either 5¼" or 8" diskettes together with Boot PROMs.

Service and Support

If you are impressed with the specifications so far, there is more to come. Our packaged sub-systems are assembled in-house and they carry a full one year parts and labour warranty. Our controllers are built completely from TTL logic — there are no fancy chips — so we can fix them if they ever break down. Dozens of floppy disc drives go through our workshops every month and we are well known within the industry both for our training courses and our heavy investment in computer based disc test equipment. If your Winchester ever stops working you can depend on us to fix it.

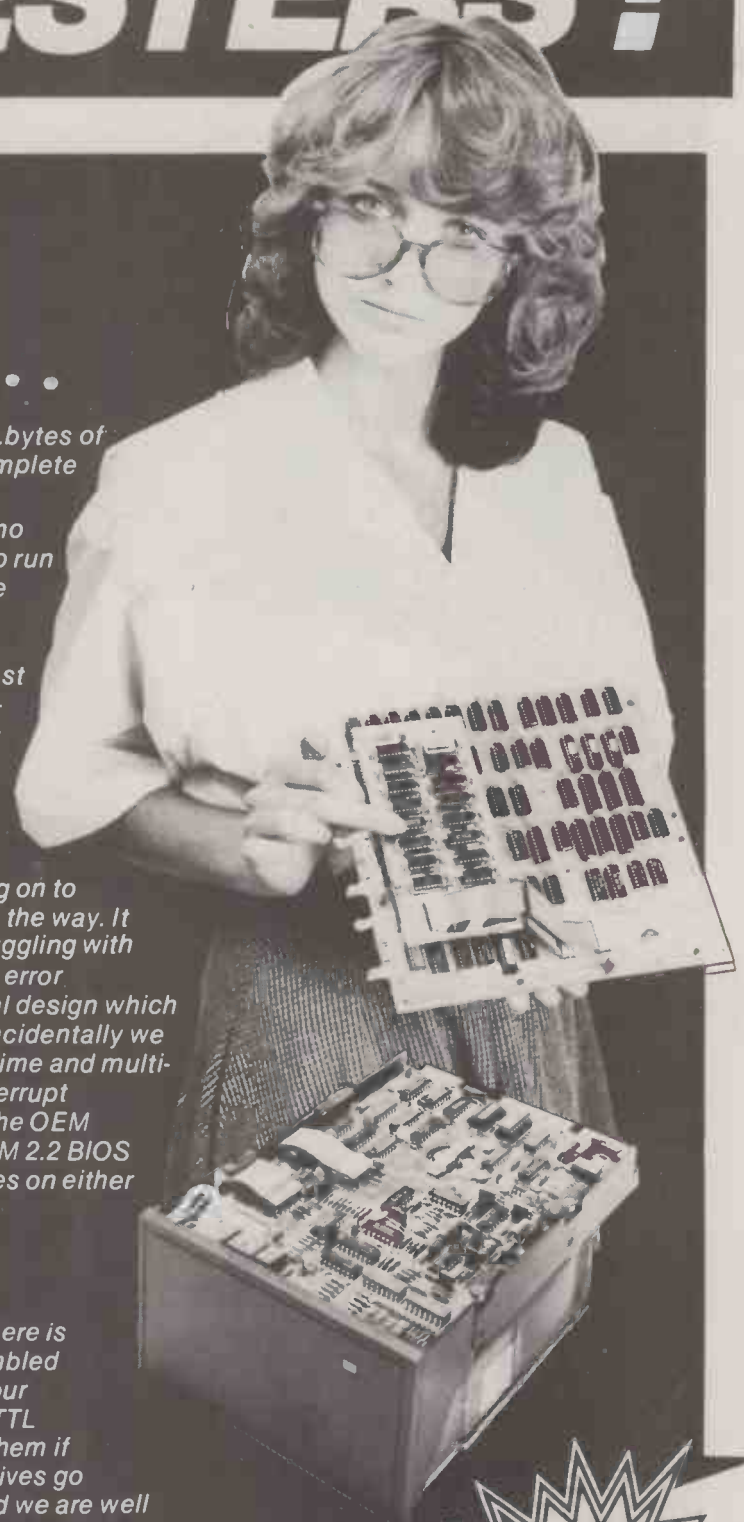

For:
SUPERBRAIN,
S-100, APPLE II,
HEATH H89,
TRS-80.

DEALER
ENQUIRIES
INVITED

● Circle No. 117

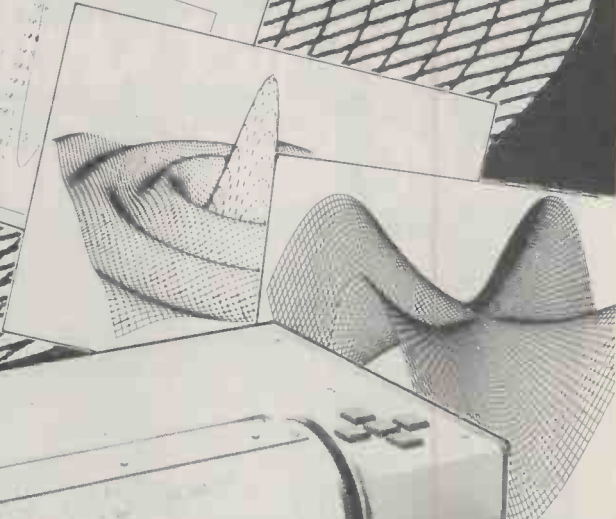
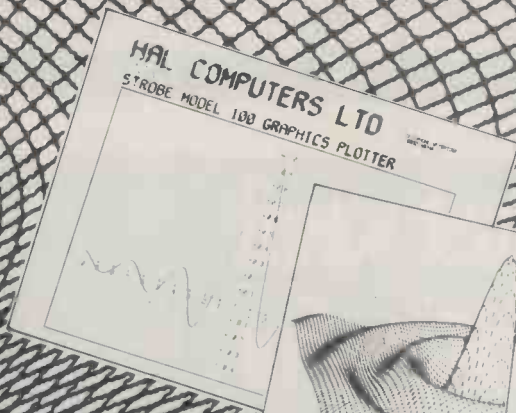

VECTOR PLOTTING, MICRO PRICE

The new Strobe Model 100 drum-type plotter gives you real vector plotting, interfacing to your computer hardware and system software, from only £690*
* High resolution — 0.1mm at 7.6cm/sec. * A4 paper capacity. * Will plot in most colours, uses off-the-shelf felt tip pens. * Precise operator control. * Interactive input of coordinates.

Driver Routines

The Strobe Model 100 can be interfaced to any computer through two parallel 8-bit output ports and one 8-bit input port. Optional interfaces for TRS-80*, Apple II*, PET*, and S-100 bus computers are currently available.
Source listings of the assembly language motor drivers and vector plot routines for use on 8080, Z80, and 6502 microprocessors are supplied with Model 100. Flow charts of these routines simplify modifications of drivers for custom machine level software.

* Unit price for plotter ex-delivery and ex-VAT
* TRS-80, APPLE II, and PET are trademarks of Tandy Corp., Apple Computer Co., and Commodore Business Machines Inc., respectively.

HAL Computers Limited
Invincible Road, Farnborough
Hants. GU14 7QU.
Telephone 0252 517171

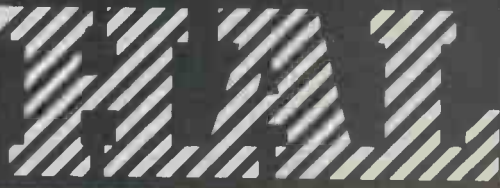

DEALER ENQUIRIES INVITED

● Circle No. 118

Now we never say no

Icarus can now offer a complete range of microcomputers from 320K-60M

COMMANDER COMPUTERS

IEEE Communications Port with 4 RS-232 serial ports and 4 8-bit parallel ports. Full graphics standard. Three models - the fully self-contained 964 with integral 9" video display, the F64 with 2 8" disk drives and the M64 with one 5" disk drive.

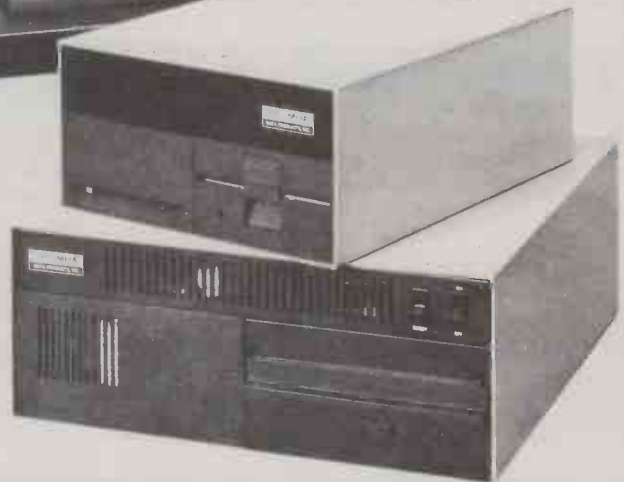

MULTI-USER MULTI-PROCESSOR SYSTEMS

Designed to give unparalleled performance for one to 16 users. Each terminal has a dedicated processor with its own RAM.

SINGLE AND MULTI-USER UPGRADEABLE/EXPANDABLE SYSTEMS

Offering the disk storage capacity that's exactly right for you. Single user machines to take 5 1/4" or 8" floppy disks giving 320K-2.4M capacity and multi-user machines with up to 60M on hard disk.

A comprehensive new range of microcomputers so versatile that a system may be compiled for each and every micro-based application - that's the exciting news from Icarus. Columbia Data Systems of the USA has appointed Icarus to handle its full range of CP/M and MP/M single and multi-terminal products with hard and floppy disk storage capacities. Which means that whenever you need a microcomputer, for whatever purpose, Icarus will never have to say no.

For full details of the complete Columbia range, or if you would like to become a dealer yourself, contact

ICARUS
Computer Systems Ltd.

Icarus Computer Systems Ltd. Deane House 27 Greenwood Place London NW5 1NN Tel: 01-485 5574 Telex: 264209

● Circle No. 119

The Printer People

OKI MICROLINE

82A

SMALL, LIGHT, QUIET, 9X9 DOT MATRIX PRINTER with
 • TRUE DESCENDERS • BIDIRECTIONAL PRINTING • 120
 CPS • 80/132 COLUMNS • GRAPHICS • DUAL INTERFACES
 • OPERATES WITH TRS-80, APPLE, and others • PLAIN
 PAPER - UP TO 4 PART • FULL 96 ASCII CHARACTER SET
 • DOUBLE WIDTH CHARACTERS • 6 AND 8 LINES PER IN.
 • PAPER TEAR BAR • And many other features.



EPSON

MX80

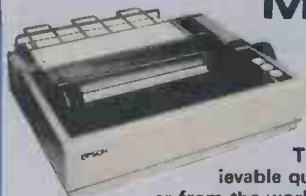

The unbelievable quality printer from the world's largest print head manufacturer. A whole stable of machines to suit a wide variety of applications: MX80/1, MX82, MX 80FT/1 & MX80 FT/New Type 2.

ANACOM

150



150 CPS, 15" carriage, dot matrix printer, 9x9 dot matrix, 10 characters per inch horizontal, 6 or 8 characters vertical, 136 cols.

TVI

912/910/950



Fully intelligent terminals with 24x80 display & dual intensity, blinking, reversed, underlining and protect fields, 96 ASCII chrs etc.

OKI

83A



Serial dot matrix printer with an impressive list of features including: 136 cols, 120 cps bidirectional, short line seeking, graphics, dual interfaces, 96 ASCII

NEC

5510/5530



5510-RS232 5530-Centronics 8 bit parallel printers with the unique print thimble, produces up to 5 copies, with friction or tractor feed at 55 chrs. per sec.

HAZELTINE

ESPRIT

The Hazeltine Esprit is a buffered terminal capable of displaying the complete 128 ASCII character set. Based on a 12" diagonal non-glare CRT, the video is crisp and clear with each character presented on a large matrix to reduce eye fatigue.



TEC

STARWRITER



Daisy wheel printer for word processing, professional results, Diablo compatible, suitable for most micro & mini computers,

RICOH FLOWRITER

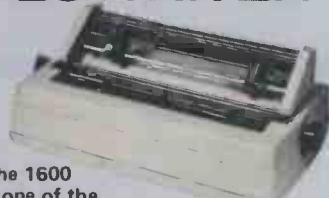

The 1600 is one of the most advanced daisy wheel printers on the world market today. With a unique combination of features.

NORTHAMBER LIMITED

3 & 4 DAWESCOURT,
ESHER, SURREY.

Tel: Esher (0372) 62071 or
88398 (from 01 nos. dial
78-62071 or 7866398)

Importers, Distributors & Wholesalers of quality Computer products.

for your nearest stockist phone

0372 62071

If you want a Printer tomorrow - call us today

SYSTEM 4000 EPROM EMULATOR/PROGRAMMERS

EX-STOCK



P4000 PRODUCTION EPROM PROGRAMMER

This unit provides 'simple, reliable' programming of up to 8 EPROMs. It has been designed for ease of operator use — a single 'program' key starts the blank check — program — verify sequence. Independent blank check and verify controls are provided along with mode, pass/fail indicators for each copy socket and a sounder to signal a correct key command and the end of a programming run. Any of the 2704/2708/2716 (3 rail) and 2508 / 2758 / 2516 / 2716 / 2532 / 2732 EPROMs may be selected without hardware or personality card changes.

2 year warranty. Price **£545 + VAT:**
+ **£12.00 DELIVERY**

VM10 VIDEO MONITOR

This compact, lightweight Video Monitor gives a clean crisp picture on its 10" screen. Suitable for use with the EP4000, SOFTY and other systems. 12 month warranty. Price **£88 + VAT, carriage paid.**

MODEL 14 EPROM ERASERS

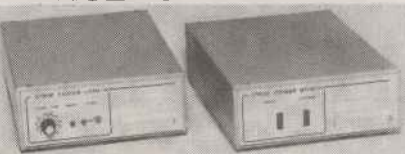

MODEL UV140 EPROM ERASER

Similar to model UV141 but with out timer. Low price at **£61.50 + VAT, postage paid.**

EP4000 EPROM EMULATOR/ PROGRAMMER

The microprocessor based EP4000 has been designed as a flexible, low cost, high quality unit for emulating and programming all the popular NMOS EPROMs without the need for personality cards, modules or hardware changes. Its software intensive design permits selection of the 2704 / 2708 / 2716 triple rail EPROMs and the 2508 / 2758 / 2516 / 2716 / 2532 / 2732 single rail EPROMs for both the programming and emulating modes.

The video output (T.V. or monitor) for memory map display in addition to the built-in Hex LED display, for stand alone use, is unique in this type of system. This, with the double function 28 key keypad, powerful editing features, powered down programming socket, buffered tri-state simulator cable and 4k x 8 data RAM gives you the most comprehensive, flexible and compact systems available today.

2 year warranty. Price **£545 + VAT:**
+ **£12 DELIVERY**

MODEL UV141 EPROM ERASER

- 14 EPROM capacity
- Fast erase time
- Built-in 5-50 minute timer
- Safety interlocked to prevent eye and skin damage
- Convenient slide-tray loading of devices
- Available Ex-Stock at **£78 + VAT** Postage Paid

EX-STOCK

DISTRIBUTORS REQUIRED — EXPORT ENQUIRIES WELCOME

GP INDUSTRIAL ELECTRONICS LTD,

UNIT 6, BURKE ROAD, TOTNES INDUSTRIAL ESTATE,
TOTNES, DEVON.
TELEPHONE: TOTNES (0803) 863360 (Sales) / 863380 (Technical Service),
TELEX: 42596 GP ELEC

SOFTY SYSTEMS

EX-STOCK

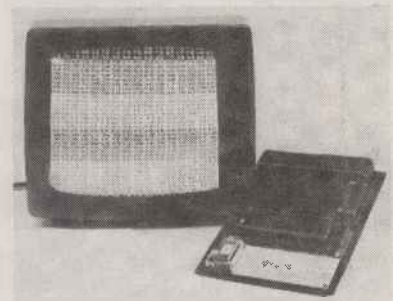

SOFTY 2 LOW COST 2716 EMULATOR/PROGRAMMER

● Direct output to T.V. ● High speed cassette interface ● On card EPROM Programmer ● Multifunction touch keypad ● 2K Monitor in 2716 ● 2K RAM ● 128 byte scratchpad RAM ● 2K EPROM Emulation ● Can program 2732/2532 in two halves ● Editing facilities including — Data entry/deletion, Block shift, Block store, Match byte, Displacement calculation ● Supplied with ZIF socket, Simulator cable, comprehensive manual, Antistatic lined EPROM tray and PSU. SOFTY 2 **£169 + VAT** (includes p&p)

SOFTY 1 LOW COST 2704/2708 EMULATOR/PROGRAMMER

● Direct output to T.V. ● High speed cassette interface — On card EPROM Programmer ● Multifunction keypad ● 1K Monitor in 2708 ● 1K RAM ● 128 byte scratchpad RAM ● 1K EPROM Emulation ● Comprehensive editing facilities ● Supplied with ZIF socket, Simulator cable and comprehensive manual.

SOFTY 1 (Built and tested) **£120 + VAT**

SOFTY 1 Power Supply **£20 + VAT**

SOFTY 1 CONVERSION CARD

Enables SOFTY to program the single rail EPROMs, 2508 / 2758 / 2516 / 2532. Selection of device type and 1K block are by pcb slide switches. ZIF Programming socket. Supplied built and tested. **£40 + VAT.**

EX-STOCK EPROMS

	1-24	25-99	100 up
2732	6:50	5:75	4:95
2716	2:80	2:60	2:40
2708	2:80	2:60	2:40

ADD VAT AT 15% - POSTAGE PAID

WRITE OR TELEPHONE FOR DETAILS
ON ANY OF OUR PRODUCTS

● Circle No. 121



The Eagle has Landed

THE EXCEPTIONAL NEW AVL EAGLE II BUSINESS SYSTEM HAS ARRIVED

The hardware comes complete with 8 software packages. A fully integrated business system incorporating order processing, ledger accounting and stock control. Plus full word-processing capabilities.

As far as we are aware, this is the only business system available that offers a totally self-contained package at such an amazing price.

The easy-to-use AVL Eagle II will reduce your paperwork, cut costs, give far greater control, and is designed to expand along with your success.

All for less than the price of a salesman's car.

Fully-integrated accounting

Take a look at the fully integrated accounting facility.

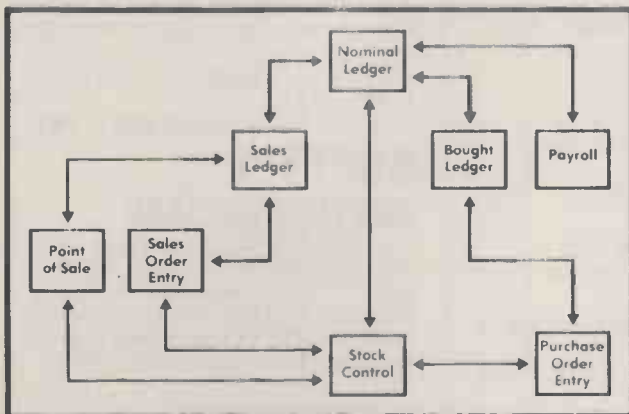

Just one single key entry is automatically entered into relevant ledgers. There's no need for manual cross-reference. This double-entry accounting system with automatic error checking will speed the updating of all your financial records and improve cash flow management.

Word-processing

The word-processing facility lets you enter information on a standard keyboard, display it on the screen, edit,

rearrange it and store it, and has the facility to prepare and sort mailing lists.

All this information can then be printed out.

Designed for business expansion

The Eagle II will grow as your business grows. It is CP/M compatible, which means a wide variety of optional software applications is available off-the-shelf. Additionally, data storage space can be increased as you require it.

And communication with other computers is also possible, when connected to the telephone system.

It's really quite difficult putting all the advantages of the Eagle II into words, which is why we'd welcome the opportunity of demonstrating its full capabilities.

Why not arrange a time and place and we'll do just that?

Contact Mediatech Business Systems Division, Woodside Place, Alperton, Wembley, Middlesex HA0 1XA, England (Telephone 01-903 4372).

Dealership enquiries welcomed.



Eagle II

The Business System

● Circle No. 122

THE HEAVY-DUTY MICRO-COMPUTER

Would you buy a car on performance figures alone?

Not likely.

You'll consider a host of other factors like quality, reliability, and warranty before choosing.

It's the same with micro-computers.

In the panel below we've listed the main performance features of the Millbank System 10:

The Millbank System 10

280A CPU 4 MHZ	IEEE 488 GP1B Parallel I/O*
65K RAM Standard	High Speed Arithmetic Processor*
700K Mass Storage on Dual Minifloppys	Real Time Clock*
Optional 1.6 Megabytes DMA Data Transfer	Attractive Desktop Cabinet
Hard Disk Interface for additional mass storage	Portable
2 RS232 Serial Ports (Printer and Modem)	Selectric Style Keyboard
1 RS449 Serial Communication Port to 500K Baud	User - Definable Function Keys
Programmable Baud Rates	Accounting- Style Numeric Pad
Separate CRT Microprocessor	Low Glare Screen
*Optional	Full Screen Editing

While it clearly establishes System 10 as a high-performance micro-computer it doesn't tell the whole story.

Because it doesn't cover the vitally important factors that make the Millbank System 10 what we call the 'heavy-duty' computer.

Like exceptionally high design quality and unique internal architecture that gives incredibly fast memory access.

Like manufacture from the highest quality components and materials available.

Like a special switching device which reduces wear and tear on major working parts.

Like a device which protects your programs and files from power failure.

And there's more. Like a non-glare screen for user comfort to take just one example.

It all adds up to a solid, reliable micro-computer with a full twelve month warranty (an important point to check).

It includes the 'industry standard' CP/M disk operating system that gives you access to a vast and ever-increasing software library.

The Millbank System 10 also gives you freedom and flexibility.

Freedom to expand to five or ten Megabyte hard disk storage.

Flexibility, through the input-output panel, to build up a micro network, add all sorts of peripherals or scientific instruments and to link up to mini and mainframe computers.

INPUT OUTPUT PANEL



The Millbank System 10 handles all forms of business accounting and management, word processing, networking, communications - it's ideal for mainframe preprocessing and data entry.

In fact, it'll do virtually everything you want from a micro-computer - consistently and reliably. See it before you make an irreversible decision.

There's almost certainly a Millbank dealer near you.

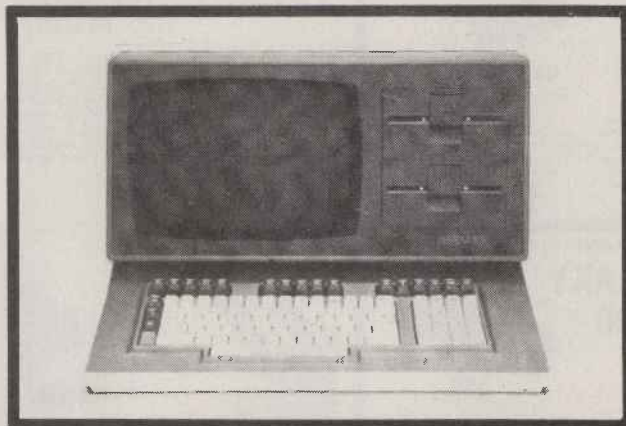

The Millbank System 10

MILLBANK
COMPUTERS

Millbank Computers Ltd.
98 Lower Richmond Road,
London SW15 1LNA
Telephone: 01-788 1083

ELECTRONIC GAMES

COLOUR CARTRIDGE T.V. GAME



SEMI-PROGRAMMABLE T.V. GAME
+ 4 Cartridges + Mains Adaptor
Normal Price £73
NOW REDUCED TO: £39.50
inc VAT

DATABASE T.V. GAME

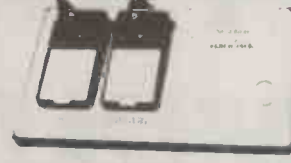

FULLY PROGRAMMABLE CARTRIDGE T.V. GAME
14 Cartridges available
Normal Price £87.86
NOW REDUCED TO: £59
inc VAT

ATARI T.V. GAME



The most popular T.V. Game on the market with a range of over 40 cartridges including SPACE INVADERS with over 112 games on one cartridge.
£95.45
inc VAT

SPACE INVADERS



Hand-held Invaders Games available £19.95
• Invaders Cartridges available to fit ATARI RADOFIN ACETRONIC PHILIPS G7000
• Cartridges also available for MATTEL TELENG ROWTRON/DATABASE INTERTON

CHESS COMPUTERS



MANY UNITS ARE COVERED BY THE EXCLUSIVE SILICA SHOP 2 YEAR GUARANTEE

We carry a range of over 15 different Chess computers:
Electronic Chess £29.95
Chess Traveller £39.95
Chess Challenger 7 £79.00
Sensory 8 £119.00
Sensory Voice £259.00
SPECIAL OFFERS:
VOICE CHESS CHALLENGER
Normal Price £245 NOW £135.00
SARGON 2.5 / BORIS 2.5
Normal Price £273.70 NOW £199.95
All prices include V A T

TELETEXT



ADD-ON ADAPTOR £199

inc VAT
THE RADOFIN TELETEXT ADD-ON ADAPTOR
Plug the adaptor into the aerial socket of your colour TV and receive the CEEFAX and ORACLE television information services.
THIS NEW MODEL INCORPORATES:
• Double height character facility
• True PAL Colour
• Meets latest BBC & IBA broadcast specifications
• Push button channel change
• Unnecessary to remove the unit to watch normal TV programmes
• Gold-plated circuit board for reliability
• New SUPERIMPOSE News Flash facility

SPEAK & SPELL



Normal Price £49.95
NOW REDUCED TO: £39.50
inc VAT
Teach your child to spell properly with this unique learning aid. Fully automatic features and scoring. Additional word modules available to extend the range of words.

ADDING MACHINE OLYMPIA HHP 1010



Normal Price £57.21
NOW REDUCED TO: £34
inc VAT
Uses ordinary paper!
No need to buy expensive thermal paper!
Fast add listing PRINTER CALCULATOR 2 lines per second. 10 digit capacity
Uses normal adding machine rolls. Battery or mains operated.
Size 9 1/2" x 4 1/4" x 2 1/4"
(Mains adaptor extra)

24 TUNE ELECTRONIC DOOR BELL

Normal Price £19.70
NOW REDUCED TO: £12.70
inc VAT
Plays 24 different tunes with separate speed control and volume control. Select the most appropriate tune for your visitor, with appropriate tunes for different times of the year!

MATTEL T.V. GAME

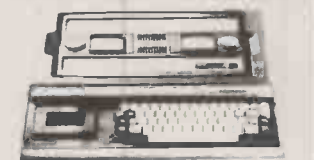

The most advanced TV game in the world 20 cartridges available Add on KEYBOARD coming soon to convert the MATTEL to a home computer with 16K RAM fully expandable and programmable in Microsoft Basic. Other accessories will be available later in the year.
£199.95
inc VAT

HAND HELD GAMES EARTH INVADERS



These invaders are a breed of creature hitherto unknown to man. They cannot be killed by traditional methods they must be buried. The battle is conducted in a maze where squads of aliens chase home troops. The only way of eliminating them is by digging holes and burying them.
£23.95
inc VAT

THE OLYMPIA — POST OFFICE APPROVED TELEPHONE ANSWERING MACHINE WITH REMOTE CALL-IN BLEEPER

This telephone answering machine is manufactured by Olympia Business Machines, one of the largest Office Equipment manufacturers in the U.K. It is fully POST OFFICE APPROVED and will answer and record messages for 24 hours a day. With your remote call-in bleeper you can receive these messages by telephone wherever you are in the world. The remote call-in bleeper activates the Answer/Record Unit, which will at your command repeat messages, keep or erase them, and is activated from anywhere in the world, or on your return to your home or office. The machine can also be used for message referral, if you have an urgent appointment, but are expecting an important call simply record the 'phone number' and location where you can be reached. With optional extra



bleepers (£13 each) this facility can be extended to colleagues and members of the family. Using a C90 standard cassette you can record as many as 45 messages. The announcement can be up to 16 seconds long and the incoming message up to 30 seconds long. The machine is easy to install and comes with full instructions. It is easily wired to your junction box with the spade connectors provided or alternatively a jack plug can be provided to plug into a jack socket. Most important, of course, is the fact that it is fully POST OFFICE APPROVED. The price of £135 (inc. VAT) includes the machine, an extra-light remote call-in Bleeper, the microphone message tape. A C mains adaptor The unit is 9 1/2" x 6" x 2 1/2" and is fully guaranteed for 12 months. The telephone can be placed directly on the unit — no additional desk space is required.
£135
inc VAT

PRESTEL VIEWDATA

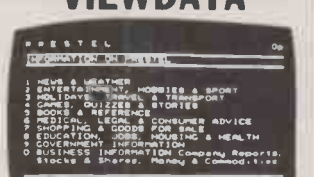

The ACE TELCOM VDX1000 Prestel Viewdata adaptor simply plugs into the aerial socket of your television and enables you to receive the Prestel Viewdata service in colour or black & white.
Features —
— Simplified controls for quick, easy operation
— Special graphics feature for high resolution
— State-of-the-art microprocessor controller
— Standard remote telephone keypad with Prestel keys
— Auto dialler incorporated for easy Prestel acquisition
— True PAL colour encoder using reliable IC chroma filter and delay line incorporated for minimum picture interference maximum fidelity
— Includes convenient TV — Prestel switchbox
— Easily connected to standard home or office telephone lines
— Fully Post Office approved
SPECIAL PRICE £228.85
inc VAT

HAND HELD GAMES GALAXY 1000



The 2nd generation Galaxy Invader. The invaders have re-grouped and have a seemingly endless supply of spacecraft whilst the player's arsenal is limited to just 250 missiles to be launched from 3 missile stations. You have to prevent the invaders landing or from destroying your home defences.
£19.95
inc VAT

FOR FREE BROCHURES — TEL: 01-301 1111



For free illustrated brochure and reviews on our range of electronic games please telephone 01 301 1111. Free delivery service available. To order by telephone please quote your name, address and ACCESSBARCLAYCARD number, and leave the rest to us. Post and packing Five of Charge Express 48hr delivery service available.
CALLERS WELCOME Demonstrations daily at our Sidcup shop open from 9am 6pm Monday Saturday (Early Closing Thursday 1pm) Late Opening Friday 8pm
2 YEAR GUARANTEE All goods are covered by a full year's guarantee and many are further covered by our exclusive Silica Shop 2 year Guarantee
MONEY BACK UNDERTAKING If you are unsatisfied with your purchase and return it within 7 days we will give you a full refund.
AFTER SALES SERVICE Available on all machines out of guarantee
COMPETITIVE PRICES We are never knowingly undersold
HELPFUL ADVICE Available on the suitability of each machine
CREDIT FACILITIES Full credit facilities available over 12, 24 or 26 months at competitive rates of interest
PART EXCHANGE SCHEME available on second hand machines
CREDIT CARDS WELCOME Access Barclaycard Diners Club American Express



SILICA SHOP LIMITED PC 12/81
1-4 The Mews, Hatherley Road, Sidcup, Kent DA14 4DX
Telephone: 01-301 1111 or 01-309 1111

SIRTON COMPUTERS



WE HAVE MOVED TO: Unit 14, 29 Willow Lane, Mitcham, Surrey
Tel: 01-640 6931/2/3

NOW WITH MP/M

MIDAS S.100 SYSTEMS

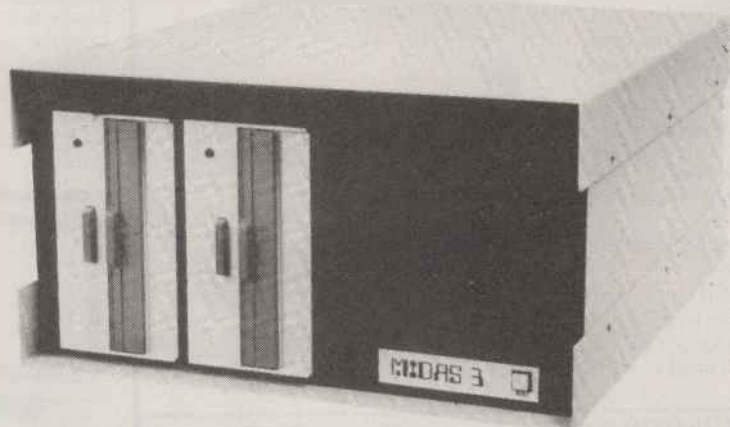

MIDAS 1: From £835
MIDAS 2: From £1,790
MIDAS 3: From £2,450
MIDAS 3HD: From £5,495
ITHACA-DPS 1: From £1,345

- Our versatile Z80 Microcomputers are available as standard units or custom configured to your exact specification from a comprehensive range of stocked S100 boards.
- Disc storage capacity of the MIDAS 3 can be 2M Bytes, expandable to over 80M Bytes with a Winchester Hard Disc Unit in our MIDAS 3HD range.
- MIDAS runs CP/M and MP/M. Other Software includes M-BASIC, C-BASIC, FORTRAN, COBOL, CIS-COBOL, PASCAL and Word Processing.
- A MIDAS 3, with 64K RAM and 2M Bytes storage on two 8" drives with two Serial I/O Ports and CP/M 2 only £3,065
- Multi-User System (four users) — MIDAS 3 with 112K of RAM, 1MByte disc storage on two 8" drives and four Serial I/O Ports, and CP/M2 + MP/M — £4,250
- Multi-user Hard Disc System (three users) — MIDAS 3HD with 160K of RAM, 1MByte Floppy Disc and 10MByte Winchester Disc; Four Serial I/O Ports and CP/M 2.2 + MP/M — £5,550
- Printers, VDUs and other peripherals stocked to give complete package system at keen prices.

Boards stocked from Ithaca, Godbout, SSM, S D Systems, Vector, Micromation, Mullen, Mountain Hardware, Hi-Tech, Video Vector, Pickles & Trout, Cromemco, Morrow — Send for full Price List (many available in kit form).

Processor Boards		RAM Boards	
Z80 Starter Kit	£245	Dynamic RAM 16K-64K	from £205
SBC100	£265	Static RAM 16K-64K	from £205
8085/88 CPU	£185	Memory Manager	£60
Z80 CPU 4 MHz	from £180	I/O Boards	
EPROM Boards		2S/4P prov 4K RAM/4K ROM	£185
2708 EPROM (16K)		2S/2P or 2S/4P or 3P/1S or 4S/2P	from £140
2708/2716 Programmers	from £140	Analogue 8 or 12 bit	from £220
Video Boards		Optically isolated I/O	£130
16 lines, 32/64 ch	from £114	IEEE 488 interface	£350
24 lines, 80 ch	from £290	Miscellaneous	
Disc Controllers		Real Time Clock	£180
Versafloppy S/D	£210	High Dens Graph/8K RAM	£333
Doubler D/D	£310	Hi-Tech Colour	£296
Godbout D/D — DMA	£280	Motherboards — various	from £34
Mainframes		Extender Board/logic probe	£39
We are the sole UK Distributor for Integrand Mainframes and Disc Enclosures, available in nine models including Desk Top and Rack Mounting, with or without provision for Disc Drives. All units totally enclosed, painted on all external surfaces and complete with power supply etc.		Maths Board AMD 9511	£330
Software			
CP/M 1 & 2, MP/M, PL/1, C-BASIC 2, M-BASIC V5, XYBASIC, FORTRAN 80, COBOL 80, CIS-COBOL, PASCAL/Z, PASCAL M/T, Forth, MAC, ZSID, Disassembler, Wordstar, Datastar, Magic Wand, Wordmaster, Supersort etc etc.			

WRITE OR PHONE FOR CATALOGUE
PRICES EXCLUSIVE OF VAT

● Circle No. 125

THE Video Genie EG3000 Series

WITH *16K user RAM plus extended 12K Microsoft BASIC in ROM *Fully TRS-80 Level II software compatible *Huge range of software already available *Self contained, PSU, UHF modulator, and cassette *Simply plugs into video monitor or UHF TV *Full expansion to disks, and printer *Absolutely complete just fit into mains plug.



16K **£299** + VAT

GP80 The most compact 80 column impact graphic-dot printer available - at a very compact price

by seikosha

Graphics, Normal and Double-Width Characters can be printed on the same line. Pine Feed

Tractor is equipped as standard.

Two Line-Feed

Commands (1/6 and 1/9 inch)

Print on Plain Paper with two copies

Continuous Self-Inking Ribbon for easy handling

Centronics type Parallel Interface standard

Wide Range of Optional Interface Boards

Self-Test Programme standard



£225 + VAT

SUPERBRAIN

SuperBrain's CP/M operating system boasts an overwhelming amount of available software in BASIC, FORTRAN, COBOL, and APL. Whatever your application... General Ledger, Accounts Receivable, Payroll, Inventory or Word Processing, SuperBrain is tops in its class.

320K **£1850** 700K **£2400**
1.5Mb **£2750**

COMMODORE COMPUTERS

PET 8K **£415**
PET 16K **£525**
PET 32K **£650**
PET 8032 **£895**

DISK DRIVES

4040 **£695**

PRINTERS

EPSON TX80B (inc. I/F & cable) **£299**
EPSON MX80T **£395**
ANADEX DP8000 **£495**
ANADEX DP9500 **£895**
ANADEX DP9501 **£995**

VIDEO MONITORS

10" BLACK & WHITE **£85**
10" GREEN SCREEN **£95**

Aculab

Floppy Tape

The tape that behaves like a disk.

Connects directly to TRS-80 level 2 keyboard. Operating and file handling software in ROM 8 commands add 12 powerful functions to level 2 BASIC. No buttons, switches or volume controls. Full control of all functions from keyboard or program. Maintains directory with up to 32 files on each tape.

for all TRS 80 & Video Genie owners

TRS80 version: **£165**

Video Genie: **£170**

Please add **£10 Securicor** delivery charge to all computers etc.
Plus 15% VAT on all prices.

Acorn Atom



£150

Unique in concept — the home computer that grows as you do!

Special features include
*FULL SIZED KEYBOARD
*ASSEMBLER AND BASIC
*TOP QUALITY MOULDED CASE
*HIGH RESOLUTION COLOUR GRAPHICS

Simple to build, simple to operate. A powerful, full facility computer with all the features you would expect.

Just connect the assembled computer to any domestic TV and power source and you are ready to begin.

Full-sized QWERTY keyboard
6502 Microprocessor Rugged injection-moulded case 2K RAM
8K HYPER-ROM 23 integrated circuits and sockets Audio

cassette interface UHF TV output Full assembly instructions

£120 + VAT

The Second Generation Personal Computer

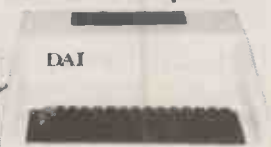

Highest performance - lowest price

*48K (8080A)
*16 Colours or shades of Grey
*Multiple High Resolution Graphics Modes (64 x 71, 129 x 159, 255 x 335)
*Character mode (60 x 24)
*Split Screen Modes

*Full ASCII Upper & Lower Character Set
*Unique graphical — Sound Commands for Smooth Music, random frequencies & enveloped sound!

DAI Personal Computer

*RS232 I/F at only **£595** + VAT

Paper Tiger 460

The Paper Tiger 460 sets new standards by incorporating many features previously only available on units costing much more.

Features like a specially developed nine wire 'staggered column' head which overlaps the dots of each matrix character with just one pass of the printhead giving a dense, high quality print image without reducing the units 160 c.p.s. print speed.

It also offers a bi-directional logic seeking device to enhance its print optimisation characteristics and wide range of 'print versatility' features such as mono or proportional spacing, automatic justification, programmable horizontal and vertical tabbing, and 'fine' positioning for word processing applications.

Paper Tiger 560

£795 + VAT

The Paper Tiger 560 is the first printer which bridges the gap between conventional matrix and 'daisy wheel' types offering quality printing at a relatively low price.

Full 'width' 132 column printing at 160 c.p.s., a unique nine wire 'staggered' print head, bi-directional printing, an inbuilt tractor feed and a host of selectable features set it apart from ordinary matrix printers.

Plus for even greater versatility a full dot plot graphics facility if supplied which includes a 2K buffer.

£995 + VAT

Books & bits

Books — Manuals —

Diskettes — ribbons — Paper

— chips (2114 x 2 1K) **£4** pair.

RS232 to Centronics interfaces **£40** etc. etc.

A variety of second-hand computer

equipment usually available,

spares, repairs and service.

MicroStyle

9 St. Peter's Terrace, Lower Bristol Road, Bath, BA2 3BT
Telephone: (0225) 334659.

New Showroom
OPENS 1st JUNE AT
29 BELVEDERE, BATH.
2 minutes from town centre

● Circle No. 126

The new flexible multi-user system

The Vector Graphic 5005

from Almarc

with 5 megabyte Winchester, 630k floppy disc

The new Vector 5005 is a multiple-user, multi-tasking hard disc system for general business and word processing applications.

It is a low priced system with highly rated capabilities.

It supports up to a maximum of 5 users and gives 5 megabytes of high-speed totally reliable Winchester disc technology with Vector's automatic error correction feature. It is also MP/M compatible.

Total flexibility means that the VG 5005's terminals can work independently which permits the widest possible range of usage. One user could use Execuplan for financial planning whilst the second user is entering sales information with accounting software and the third may run correspondence simultaneously with Vector's Memorite III word processing software. Each user gets a full 56k bytes of RAM and most other standard CP/M

compatible applications software will run on the system e.g. COBOL, FORTRAN, PASCAL, BASIC COMPILER, ALGOL, PL/I and other statistical and data based management packages.

The Vector Graphic 5005 is ideal for application packages, such as accounts, stock control, payroll, word processing, financial modelling and solicitors packages, all available from Almarc.

For further information on the VG 5005 write or telephone Almarc. Complete sales and servicing facilities are available throughout the U.K.

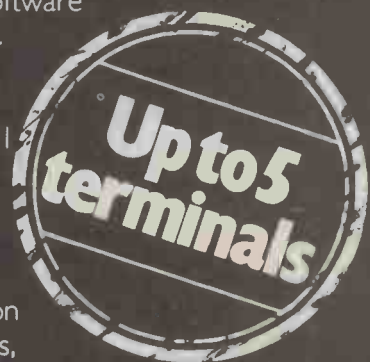

Almarc

DATA SYSTEMS

Almarc Data Systems Limited,
Great Freeman Street,
Nottingham NG3 1FR.
Tel: (0602) 52657.
Telex: 37407 Almarc/G.

Also at:
Green Street,
High Wycombe,
Bucks. HP11 2RF.
Tel: (0494) 23804.



EXATRON STRINGY FLOPPY

for TRS-80
users only

£120 each.

Dealer Price 5 for
£400.

MBS TERMINALS LTD.

119-120 High Street,
Eton, Windsor, Berks.

● Circle No. 128

S.B.D. Software is proud to announce their distribution agreement with the most up to date APPLE-only magazine in America.

CALL A.P.P.L.E.

Now you can purchase this outstanding magazine for the low price of £1.75 per issue.

Your subscription for 12 or 24 magazines may start from any month in 1981.

Single back Issues are available at £2.25 per issue including postage and packing.

A bound volume of the 9 issues in 1980 is available for £20.00 including postage and packaging.

(Please note that in 1980 & 1981 there were only 9 issues published but in 1982 there will be 12 issues.)

SPECIAL INTRODUCTORY OFFER
expires 31st December 1981

12 issues @ £19.50 24 issues @ £39.00
Act Now and Save

NAME

ADDRESS

TOWN

POSTCODE

12 issues Sub. @ £19.50 24 issues Sub. @ £39.00

Please start my subscription Month Year

Barclaycard/Access Number Expiry Date

Please make cheques payable to CALL APPLE (UK)

Send to:- CALL APPLE (UK)
c/o SBD Software
FREEPOST
RICHMOND
SURREY TW9 1BR
(No postage stamp required)
Telephone: 01-940 5194

● Circle No. 129

STOP PRESS!

MZ-80K

with 48 Kbytes of memory
and integrated cassette



FOR **£345** + VAT

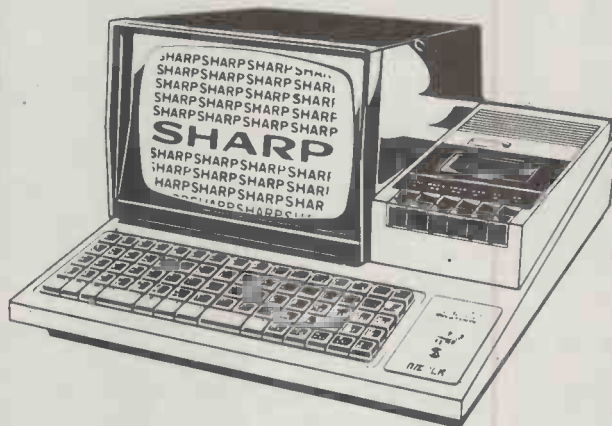

MAIL ORDER ONLY

Cash/cheque with order please.

FULL RANGE OF
SHARP COMPUTER PRODUCTS
AVAILABLE



For quote contact
**CHESHIRE COMPUTER
SERVICES LIMITED**
Broom House, Highfield Road,
Manchester M19 3WD.
Tel: 061-224 9680.

● Circle No. 130

PRACTICAL COMPUTING December 1981

TRS 80 MODEL III DUAL DENSITY DISK DRIVES



INTERNAL DRIVE PRICES

1 x 40 TRACK DRIVE	£420	184K BYTES
2 x 40 TRACK DRIVES	£599	368K BYTES
1 x 80 TRACK DRIVE	£490	368K BYTES
2 x 80 TRACK DRIVES	£729	737K BYTES
2 x 80 TRACK DOUBLE SIDED DRIVES	£999	1474K BYTES

INTERNAL DRIVE PRICES INCLUDE DISK CONTROLLER BOARD, POWER SUPPLY UNIT AND ALL CABLES AND CONNECTORS REQUIRED FOR INSTALLATION.

CAPACITY

EXTERNAL DRIVE PRICES

1 x 40 TRACK DRIVE	£236
2 x 40 TRACK DRIVES	£440
1 x 80 TRACK DRIVE	£299
2 x 80 TRACK DRIVES	£569
EXTERNAL 2 DRIVE CABLE	15.50

EXTERNAL DRIVES ARE DIRECTLY COMPATIBLE WITH THE TRS 80 MODEL I AND VIDEO GENIE EXPANSION INTERFACES.

Call your nearest dealer for a demonstration:

RADIO SHACK LTD.,
188, Broadhurst Gardens,
London NW6
Tel: 01-624-7174

COMP SHOP LTD.,
14, Station Road,
New Barnet, Herts.
Tel: 01-441-2922

COMP SHOP LTD.,
311, Edgware Road,
London W2
Tel: 01-262-0387

COMP SHOP LTD.,
19, Herbert Street,
Dublin 2
Tel: 604165

**LONDON COMPUTER
CENTRE**, 43, Grafton
Way, London W1
Tel: 01-388-5721

N.I.C.,
61, Broad Lane,
London N15.
Tel: 01-808-0377

**CROYDON COMPUTER
CENTRE**, 29a, Brigstock
Road, Thornton Heath,
Surrey.
Tel: 01-689-1280

P J EQUIPMENT LTD.,
3, Bridge Street,
Guildford
Tel: 0483-504801

**R.D.S. ELECTRICAL
LTD.**, 157-161, Kingston
Road, Portsmouth
Tel: 0705-812478

**TANDY HASTINGS
LTD.**, 48, Queens Road,
Hastings.
Tel: 0424-431849

**MICROWARE
COMPUTING
SERVICES**, 57, Queen
Charlotte Street, Bristol
Tel: 0272-279560

**BLANDFORD
COMPUTERS**, Higher
Shaftsbury Road,
Blandford Forum
Tel: 0258-53737

TAPE SHOP
32, Viaduct Road,
Brighton.
Tel: 0273-609099
PARWEST LTD.,
18 St. Mary Street,
Chippenham.
Tel: 0249-2131

COMPUTER SHACK
14, Pittville Street,
Cheltenham.
Tel: 0242-584343

ENSIGN,
13-19, Millford Street,
Swindon, Wilts.
Tel: 0793-42615

**TANDY
GLOUCESTER**,
13, Clarence Street,
Gloucester
Tel: 0452-31323

COMSERVE,
98, Tavistock Street,
Bedford.
Tel: 0234-216749

**CLEARTONE
COMPUTERS**, Prince of
Wales Ind. Estate,
Abercarn, Gwent
Tel: 0495-244555

EMPRISE LTD.,
58, East Street,
Colchester.
Tel: 0206-865926

**MAGNUS MICRO-
COMPUTERS**,
139 The Moors,
Kidlington, Oxford.
Tel: 08675-6703

**CAMBRIDGE
COMPUTER STORE**,
1, Emmanuel Street,
Cambridge
Tel: 0223-65334

I.C. ELECTRONICS,
Flagstones,
Stede Quarter,
Biddenden, Kent.
Tel: 0508-291816

MICRO CHIP SHOP,
190, Lord Street,
Fleetwood, Lancs.
Tel: 03917-79511

**HARDEN MICRO-
SYSTEMS**, 28-30, Back
Lord Street, Blackpool.
Tel: 0253-27590

**AMBASSADOR
BUSINESS COM-
PUTERS LTD.**,
Ashley Lane Works,
Shipley, W. Yorks
Tel: 0274-595941

Q-TEK SYSTEMS LTD.,
2 Daltry Close, Old
Town, Stevenage, Herts
Tel: 0438-65385

COMPUTER & CHIPS
Feddinch Mains House,
St. Andrews, Fife,
Scotland
Tel: 0334-72569

**NORTH WEST
COMPUTER
CONSULTANTS LTD.**,
214 Market Street,
Hyde, Cheshire
Tel: 061-365-8624

**HEWART MICRO-
ELECTRONICS**,
95, Blakelow Road,
Macclesfield.
Tel: 0625-22030

KARADAWN LTD.,
2 Forest Way,
Great Sankey,
Warrington.
Tel: 0925-572668

PHOTO-ELECTRICS,
459 London Road,
Sheffield.
Tel: 0742-53865

ARC ELECTRONICS,
54, Heron Drive, Sandal,
Nr. Wakefield,
W. Yorks WF2 6SL
Tel: 0524-253145

**VICTOR MORRIS
LTD.**, 340 Argyle
Street, Glasgow,
G2 8LY
Tel: 041-221-8958

THOMAS WRIGHT LTD.,
Thorite House,
Laisterdyke,
Bradford.
Tel: 0274-663471

GNOMIC LTD.,
46, Middle Street,
Blackhall,
Hartlepool.
Tel: 0783-863871

**BRIERS COMPUTER
SERVICES**, 1, King
Edward Square,
Middlesborough,
Cleveland.
Tel: 0642-242017

3 LINE COMPUTING,
36, Clough Road, Hull.
Tel: 0482-445496

**H.C. COMPUTER
SALES LTD.**, 182,
Earlsway, Team Valley
Trading Estate,
Gateshead.
Tel: 0632-874811

EWL COMPUTERS LTD.,
8, Royal Crescent,
Glasgow.
Tel: 041-332-7642

CUMANA LTD 35 Walnut Tree Close, Guildford, Surrey, GU1 4UN.
Telephone: (0483) 503121.

Please add VAT to all prices.
Delivery at cost will be advised
at time of order.

● Circle No. 131

PRINTERS

SEIKOSHA GP-80

The Smallest 80 Column Dot Matrix Printer.

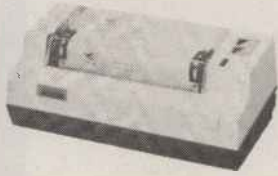

Unique printer principle. 80 col lines. 30 cps. 12 cpl Plain Paper. Tractor drive. Weight 2.5 kg. Footprint 12.6 sq. ins. Bit addressable graphics. Parallel interface standard. RS 232 Apple Pet TRS 80 options

£199

OKI MICROLINE 80 & 82A

Compact 80 Column Printer.

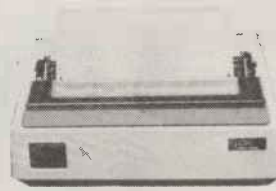

80-120 cps. Uni direction ML 82A bi-direction). Parallel interface. Serial interface option. (ML 82A standard). Pin and friction feed. Tractor option. Condensed and expanded characters. 80, 40, 66 and 132 cpl.

ML 80 £299
ML 82A £437

EPSON MX SERIES

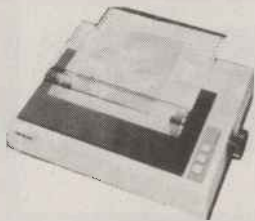

Low Noise, Low Price-High Performance Printer

Six models. 80 cps. Bi-directional. Parallel interface. RS232 Pet Apple TRS 80 Video Genie Sharp options. Letter quality. Lower case descenders. Condensed enlarged and bold characters. Models provide tractor roll and sheet feed - bit image graphics - up to 15 ins paper.

MX-80 £353
MX-80 F/T £399
MX-80 II £399 **MX 80 F/T-II £447** **MX-82 £447**
MX-100 £569

OKI MICROLINE 83A

Medium Speed 15" Printer.



120 cps. Bi-direction. Pin and friction feed. Tractor option. 132 cpl at 10 cpi. 4 character sizes. Graphic characters. Parallel and serial interface. Fast serial interface option.

£827

ANADEX DP-9000 RANGE

Fast, Versatile Printers.

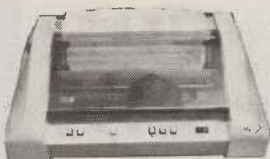

Seven models. Up to 15 inch paper width. Lower case descenders. 160-220 cps bi-directional printing. RS232 current loop & parallel interface. X on X off. Optional 2K buffer. Multiple print densities. Fast print of high-density bit image graphics.

DP-8000 £541
DP-9000L £747 **DP-9001 £888** **DP-9500 £935**
DP-9000 £841 **DP-9500L £841** **DP-9501 £982**

TEC STARWRITER

Best-Buy Daisy Wheel Printer.



Bi-direction. 25 cps. Low cost supplies. Standard Daisy Wheel. Carbon and fabric ribbons. Parallel or RS232 interface. Sheet feeder options.

Parallel Interface £1020
Serial Interface £1067

LEAR SIEGLER 310

Professional Dot Matrix Printer.



High throughput. 180 cps. Bi-direction. Fast head travel. Space skip over. Lower case descenders. Enlarged and bold fonts. Parallel RS232 and current loop interfaces. X on X off. Condensed character option. Sound reducing option.

£1386

- **Authorised distributor**
- **Rapid delivery**
- **Dealer educational & quantity discounts**
- **Prices exclude VAT**

FROM

RIVA

RIVA TERMINALS LTD.

Glendale Park, Fernbank Road, Ascot, Berkshire SL5 8JB
Tel: Winkfield Row (03447) 5193 Telex: 847530
Northern Office: Tel: Harrogate (0423) 503867

The suppliers of the first Basic Compiler for the Pet,
Oxford Computer Systems (Software), proudly announce:



PETSPEED

the first of a new generation of Basic Compilers for Commodore systems. **PETSPEED** is a fully compatible, optimising Basic Compiler for Commodore Systems. Programs written in Pet Basic may be compiled **WITHOUT** alteration to give a highly efficient object program saved as a program file on disc.

PETSPEED supports advanced features previously only available on much larger systems:

- **OPTIMISATION** — this feature, previously provided only on large computers, results both in smaller programs and much faster code.
- **DATA** — in addition to **FLOATING POINT**, **STRING** and genuine **INTEGER** arithmetic, the Compiler uses extra internal data types. Although this is completely transparent to the user, it allows many operations which would otherwise be carried out in floating point to be executed in integer arithmetic. This means **FASTER** code and more efficient operation.
- **COMPATIBILITY** — any Pet Basic programme can be compiled.
- **LONG VARIABLE NAMES** — meaningful variable names can now be used in Basic programs allowing easier **DE-BUGGING** and maintenance.
- **SPEED** — Compiled programs run at up to **30 TIMES** the speed of Pet Basic.
- **PROGRAM SIZE** — the size of long programs is considerably reduced leaving room for extra code and data.
- **COMPILING SPEED** — **PETSPEED** is driven entirely in machine code giving a Compiling Speed of **2 LINES PER SECOND**.
- **USER SUPPORT** — in addition to the fully Comprehensive manual, a telephone and postal enquiry service is available to answer questions from users of **PETSPEED**.
- **AVAILABILITY** — use **PETSPEED** for all your 8000 series programming including the **NEW 8096**.

Also available from **OXFORD COMPUTER SYSTEMS (SOFTWARE)**:

COMPILED INTEGER BASIC — a very fast Integer Compiler for **ALL** Pet models. Compiled Basic is for those applications where the speed of the machine is required without the inconvenience of assembly level programming.

"admirably fast code . . ."
"exciting extra commands . . ." *Printout*
(the Pet users magazine)

Compiled basic is already widely used in education and research. It is ideal for applications that do not require floating point arithmetic e.g.

- **DISC HANDLING** — disc operations in Compiled Basic are much faster than in Pet basic. Compiled Basic provides a set of extra **IEEE** commands to speed up the process even further.
- **FAST INPUT/OUTPUT** — Compiled Basic is ideal for fast I/O such as Datalogging, driving fast peripherals etc.
- **POKING THE SCREEN** — poking to the screen is incredibly fast in Compiled Basic. This, together with the **PLOT** command makes Compiled Basic ideal for any graphics application.
- **SEARCHING** and **SORTING** — large quantities of data can be processed at real machine code speed.
- **SPEED** — Compiled Basic programs run at up to **150 TIMES** the speed of Pet Basic

WHICH COMPILER IS SUITABLE FOR YOUR APPLICATION?

At Oxford Computer Systems we can advise on which Compiler is most suitable for you.

PETSPEED for 8000 series £225.00 **COMPILED BASIC** £150.00
PETSPEED for 8096 series £300.00 (for all Commodore Systems, including **COMPUTHINK** drives.)

★ **SPECIAL OFFER: PETSPEED** for 8000 series **PLUS COMPILED BASIC** for just **£300.00**
(if your order is received before 31 December 1981)

For further details contact:

Oxford Computer Systems (Software) Ltd.

7 & 8 Park End Street, Oxford OX1 1HH

Telephone: Oxford (0865) 722872

Palantir*

Multi Processor Systems With Hard Disc Drives

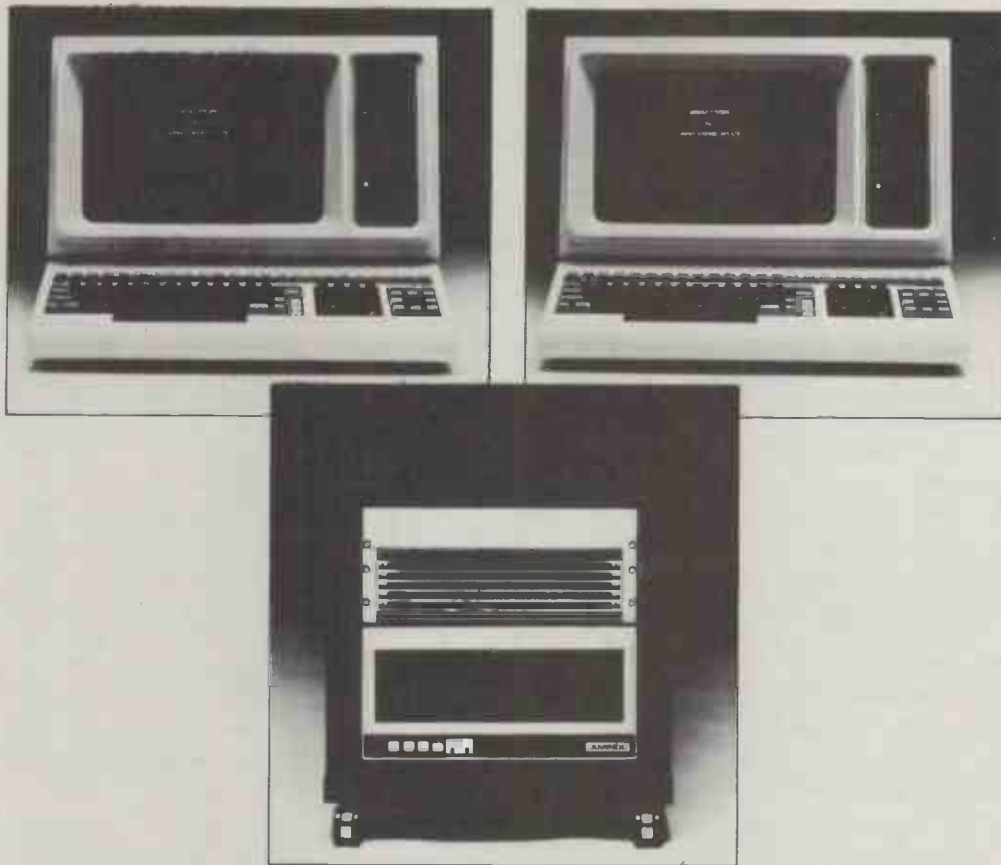

The advantages are as follows:—

1. Each professional quality terminal has its own 64K Z80A computer. In this way maximum processing speeds are achieved, avoiding delays usually associated with multi terminal systems.
2. The hard disc drive with fixed and removable discs allows rapid access of information with a data transfer rate 40 times faster than most floppy discs and 10 to 96 megabytes of storage. Daily back-up of information is very rapid and takes about 3 minutes rather than the 30 to 60 minutes involved in copying on to tape or floppy discs.
3. To provide maximum system flexibility the following options are available:— 232C serial ports (2 are standard), ASCII parallel ports, 2 megabyte dual 8" floppy drives, number of terminals expandable from 1 to 24 (more if required).
4. Industry standard CP/M allows access to a wealth of existing software. We will be pleased to quote for your special requirements. Software and hardware back-up and maintenance available throughout the U.K.

*Registered trademark applied for by Harmer Simpson (UK) Ltd.

Harmer Simpson (UK) Ltd.

Ferrari House, 258 Field End Road, Eastcote, Middlesex HA4 9UZ. Tel: 01-429 1266. Telex: 929804 HARMER G.

CP/M SOFTWARE

from

METROTECH

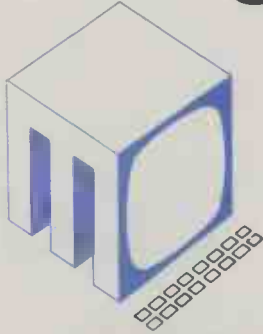

* NEW * WORDSTAR 3 * NEW *

WORD-STAR™ Version 3.xx has now been released. New features include: column move capabilities, horizontal scrolling — up to 240 columns and even clearer menus. Also released is MicroPro's own spelling checker — SPELLSTAR.

WORD-STAR 3.xx	£255/£30
MAILMERGE 3.xx (optional)	£ 60/£10
SPELLSTAR (optional)	£125

IN ADDITION METROTECH SUPPLIES A TRUE ENGLISH DICTIONARY, REPLACING US WORDS WITH ENGLISH

NEW * RECORDS MANAGEMENT * NEW

Ideal for office records including personnel, stock, clients and accounts. Features include:

- * Comprehensive calculation
- * Record selection on updates and reports
- * Full sorting facilities
- * WORDSTAR INTERFACE — for selective mailing

COMPSOFT DMS	£400/£25
--------------	----------

NEW * MICROPLAN * NEW

If you have any problem that you would normally solve with pen, paper and a calculator, then MicroPlan will help you. MicroPlan will perform most types of calculations working in rows and columns, as well as advanced financial analysis.

MicroPlan	£295/£20
-----------	----------

LANGUAGES/UTILITIES

CBASIC II	
COMMERCIAL DISK EXTENDED BASIC	£75/ £20
SBASIC	
COMPILER STRUCTURED BASIC	£175/ £30
SUPERSORT I	£125/ £20
WORD-MASTER SUPERIOR TEXT EDITOR	£75/ £20
MET/ TWAM INDEX SEQUENTIAL FILE ACCESS IN CBASIC II	£55/ £15
MICROSOFT BASIC 80 INTERPRETER	£155/ £25
MICROSOFT BASIC COMPILER	£195/ £25
MICROSOFT FORTRAN 80	£215/ £25
MICROSOFT COBOL 80	£315/ £25

MICRO DATA BASE SYSTEMS

MDBS is a database system offering full network CODASYL-oriented data structures, variable length records, read/write protection, one-to-one, one-to-many and many-to-many set relationships. Add on features are: an interactive report-writer and query system, a dynamic restructuring system and a recovery-transaction logging system.

MDBS prices start from	£600/£30
Primer manual	£5

COMMUNICATIONS

BISYNC-80/3780 and BISYNC-80/3270 are full function IBM 2780/3780 and 3270 emulators for microcomputers.

BISYNC-80/3780 gives you a Remote Job Entry terminal for the price of a micro!

BISYNC-80/3270 combines the local processing power of a micro with a sophisticated screen capability. Make your dumb terminal smart!

MET/TTY will connect your micro to a timesharing service in simple teletype emulation.

BISYNC-80/3780	P.O.A.
BISYNC-80/3270	P.O.A.
MET/TTY	£95/£15

DATA MANAGEMENT

SELECTOR III-C2

An easy to use Information Management System; requires CBASIC II

£185/£30

SELECTOR IV

An advanced Information Management System; requires CBASIC II

£275/£35

DATASTAR

Powerful data entry, retrieval and update system

£195/£30

FINANCIAL REPORTING

REPORT WRITER

You input the values — Report Writer will perform your calculations and produce a report with your headings, totals and summaries

£95/ £15

GLECTOR

General ledger option to Selector III; Requires Selector III and CBASIC II

£185/ £30

All software is **Ex-stock** except MDBS and available on standard 8" disks or 5" disks for Vector MZ, Superbrain and Dynabyte.

- * Postage and Packing £2 per order.
- * Add 15% VAT.
- * State which disk type and size.
- * All orders prepaid.

Telephone orders welcome for Access, Barclaycard, American Express or Diners Club.

CALL 0895 58111 Ext. 247 or 269

or write to:

METROTECH MAIL ORDER
WATERLOO ROAD UXBRIDGE
MIDDLESEX UB8 2YW

enclosing cheque, PO's payable to METROTECH

tml WORD-STAR is a trademark of Micropro.

Prices are shown as Software with manual/Manual only.

Prices correct at time of going to press

METROTECH are sole U.K. distributors of DYNABYTE microcomputer systems.

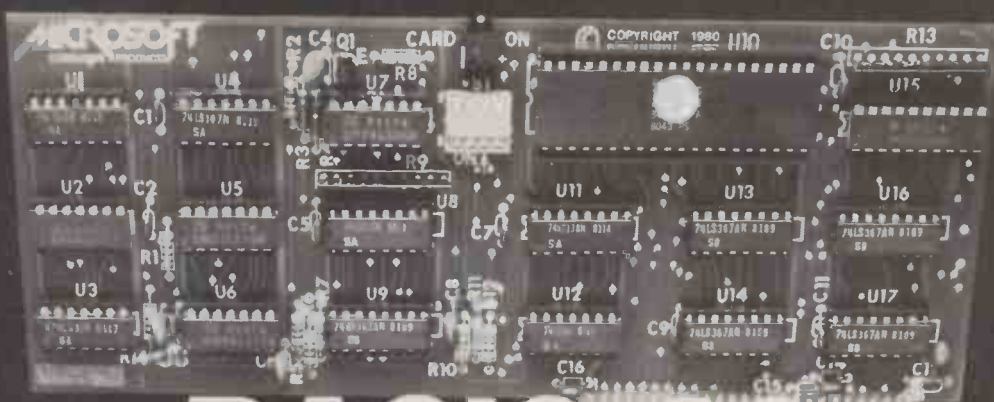

BASIC-80 CP/M



Turn your Apple into the world's most versatile personal computer.

The SoftCard™ Solution. Softcard turns your Apple into two computers. A Z-80 and a 6502. By adding a Z-80 microprocessor and CP/M to your Apple, SoftCard turns your Apple into a CP/M based machine. That means you can access the single largest body of microcomputer software in existence. Two computers in one. And, the advantages of both.

Plug and go. The SoftCard system starts with a Z-80 based circuit card. Just plug it into any slot (except 0) of your Apple. No modifications required. SoftCard supports most of your Apple peripherals, and, in 6502-mode, your Apple is still your Apple.

CP/M for your Apple. You get CP/M on disk with the SoftCard package. It's

a powerful and simple-to-use operating system. It supports more software than any other microcomputer operating system. And that's the key to the versatility of the SoftCard/Apple.

BASIC included. A powerful tool, BASIC-80 is included in the SoftCard package. Running under CP/M, ANSI Standard BASIC-80 is the most powerful microcomputer BASIC available. It includes extensive disk I/O statements, error trapping, integer variables, 16-digit precision, extensive EDIT commands and string functions, high and low-res Apple graphics, PRINT USING, CHAIN and COMMON, plus many additional commands. And, it's a BASIC you can compile with Microsoft's BASIC Compiler.

More languages. With SoftCard and CP/M, you can add Microsoft's ANSI Standard COBOL, and FORTRAN, or Basic Compiler and Assembly Language Development System. All, more powerful tools for your Apple.

Demonstration. See SoftCard at your local Apple dealer. Or we'll send it to you with a dealer list. You will find it simplicity itself to operate. Call or return the coupon to us.

SoftCard is a trademark of Microsoft. Apple II and Apple II Plus are registered trademarks of Apple Computer. Z-80 is a registered trademark of Zilog, Inc. CP/M is a registered trademark of Digital Research Inc.

Caxton Software Publishing Company, 10-14 Bedford Street, Covent Garden, London WC2. Telephone 01-379 6502

Please send me a SoftCard. I enclose a cheque for £225 (+ VAT at 15%).

Please send me further information.

User

Dealer

Name _____ Position _____ Company _____

Address _____

Primary Interest _____

40



Distributor for
MICROSOFT
CONSUMER PRODUCTS

PRC

Welcome the big boys

GOD, BEING A conservative sort of chap — not a surprising trait in one as old as He — is traditionally said to be on the side of the big battalions. At least, this was Voltaire's view, and events since his time have scarcely, if ever, proved him wrong.

We are now about to witness a new and interesting test of the old saw. The big, old computer companies have now shed their towels above high-water mark and are ankle-deep in the briny. They are audibly slapping their arms against their sides and crying out "How can it be so cold!"

In other words, IBM, Xerox and our own sickly ICL — among others — are committed to assaults on the micro market, and it will be very interesting to see what happens. On the one hand there are some friends of mine in Oxford who have been busily burrowing backwards into the sand for two years now, saying "Ooh — just wait till IBM arrives — we don't want to be caught in the open when that happens"; on the other, persons of more sanguine temperament are wondering whether the giants do not bring some pretty discouraging handicaps with them to this difficult market.

How might one delineate the issues? The straightforward argument is that the big guns will out-shoot the little guns. The whole world's micro business this year amounted to only five percent of IBM's turnover. If IBM had to give a machine to everyone who already has something from their rivals, it could. The giants have the capital manufacturing capability, the designers, the programmers, the outlets, the maintenance people — everything, in short, which the micro business has so far lacked.

There is little doubt that a lot of people who distrust micros will feel much better about the little beasts when they have one of these well-known names on the front. There is little doubt too that micros need to be made in quantity to high standards and sold through efficient dealer networks. Whether the big firms get into the business or not, this will happen spontaneously through the demands of the market.

In one of the first editorials I wrote on this page, I compared the micro business to the early days of the motor industry when

Cars then were very like microcomputers now. There were dozens of different kinds, allied only by their unreliability, incompatibility and the fanatical enthusiasm of their owners. Those owners would speak disparagingly of "horse and buggy" ideas and would happily spend six hours travelling six miles because they had had the fun of fitting new big ends after the second mile, re-wiring the ignition after the fourth and then retrieving — as Kipling so movingly describes in one of his stories — the contents of a ball-race dropped along six furlongs of un-metalled road.

Well, so it is now. The difference is that the fans of microcomputing have a more gullible public. Many people are being persuaded to ride in our new bangers. They are holding their hats and waiting for the big thrill. It may come, or, what is more likely, the whole mess of machinery may blow up, cover all concerned with hot oil and sit lifeless by the roadside.

In two years we have got to the point where the big firms are emerging — the Austins, Peugeots, Oldsmobiles. The question is, are these big companies the right big companies? The reason they might not be is twofold. Firstly, the traditional computing business is dedicated to selling answers to expensive administrative problems to people who know nothing about computing but are happy to pay several times what the hardware is worth because they are promised "total solutions".

The structure of the big-computing business means that these firms can — they have to — work with very large margins indeed. A large part of their overhead is spent on publicity and marketing. It is common for salesmen to earn 30 percent of invoices with many, many 0s.

That kind of money is paid to salesmen rather than programmers or engineers because the hard bit is in getting the customer to bite on the bullet. If customers were queueing up to buy, as they are in our business, then the salesman's 30 percent will just disappear as manufacturers compete by cutting costs. One wonders whether a company organised round selling to a small number of rich, reluctant customers can convert itself into a mass-market operation.

The second problem follows from the first. In the big-computing business, the man who signs the cheque will never sully his hands with the keyboard. He expects to get value out of his purchase through the efforts of his data-processing department. It suits everyone in this set-up to make the machine pretty complicated to use, because that increases the mumbo-jumbo that can be used to baffle the businessman and increases the DP people's hold on their jobs:

In consequence, the big computing companies are full of people who have devoted their lives to making computing difficult. If you walk into the technical department of Intergalactic WonderComps and tell them that what they are doing can be, and often is, done by ten-year-olds, they get understandably miffed. If you invite them to reverse the whole trend of their professional careers and try to make the machine easier to use rather than harder they are apt to go very limp on you.

This is unfortunate for IWC because the way things look in the micro business, hardware on its own is going to be a fairly lean market. There will be a lot of it, but the margins will inevitably be thin and a lot of the 200-300 micro manufacturers in the world must go to the wall over the next few years. The problem for the giants is that buyers of micros want the hardware only to get the software to run. But, of course, the giants are full of people who are convinced that software ought to be complicated.

Micro-software needs a completely new cast of mind. It needs people who are violently anti-elitist, who view with deep suspicion everything more complicated than counting on the fingers of one hand. They have to believe that computing is not difficult, merely tricky, and that with luck, time will make it a lot less so.

It may not be easy to get the technical people in the big companies to change their habit of thought. Ever since micros first appeared, they have regarded them as toys. Their companies are now getting into the market only because the money men can see that if they do not do something now there will not be much big-computing business left in a few years' time.

If the technicians cannot be won round, then the big companies are going to be stuck with big overheads and a very standard mass-market product which relies on other people's software to make the sales and take the profits.

There is another reason why the big companies are unlikely to do well in the key area of software. New software comes from someone with a good idea sitting down in front of a keyboard. It makes no difference whether the keyboard is in IWC's technical centre or in a front room in Walsall. Even IWC is limited to the good ideas in the heads of its employees. Even supposing they are not contaminated by obsolete doctrines, there are nowhere near as many of them in there as there are of us out here.

And that argument brings us full circle. If it turns out to be true, the future of big computing companies in the micro market looks hard. However, in the process of getting in, they will do us all a fair amount of good. They will greatly increase the stock of hardware in use in the world, and will improve the reputation of the microcomputer but, one hopes, without putting too many of us out of business. □

WEIGH US UP

NEW
SUPER PERFORMANCE SX SERIES
Multi User Multi Processor and
Networking under
TURBODOS
full CP/M
compatibility

Our advantages: —

- S-100
- 12 slots
- Z80A Microprocessor
- Real time clock
- Interrupt driven hardware
- Double density, single or double sided 5" and 8" floppy disc drives
- 5" and 8" Winchester drives (option)
- Tape back-up (option)
- Cartridge disc drives (Equinox 200)
- 64KB Dynamic RAM with parity
- Static RAM (option)
- Up to 384KB RAM (option)
- Two serial ports
- Additional serial and parallel ports (option)
- CAP Microcobot
- CP/M, CP/NET, MP/M
- TURBOCHARGER II for greater disc capacity and performance for your CP/M software
- BASIC, COBOL, FORTRAN, PASCAL, C, LISP, APL, FORTH
- Word Processing
- Information Management
- Powerful Utilities-Z80 Assembler, Editor, Debugger and linker
- Analog/Digital and Digital/ Analog interfaces
- Prestel/Viewdata
- Mainframe/Micro Communication
- Networking
- CCTA Approved Systems

Built to high quality standards by IMS International

And consider the price — from £1750

EQUINOX

COMPUTER SYSTEMS LIMITED
Specialists in Multi-user Microsystems

Kleeman House, 16 Anning Street, New Inn Yard,
London EC2A 3HB. Tel: 01-739 2387 & 01-729 4460
Telex: 27341

● Circle No. 137

Our Feedback columns offer readers the opportunity of bringing their computing experience and problems to the attention of others, as well as to seek our advice or to make suggestions, which we are always happy to receive. Make sure you use Feedback—it is your chance to keep in touch.

Conclusive evidence

BORIS ALLAN'S article on "The limits of my world" in the September 1981 issue does not show that "the world of non-recursive algorithms has increased its limits to include Ackermann's function" but that the Ackerman (A) function is a general recursive function if and only if the Griffin (G) function also is.

The A function, you will recall, is defined on the non-negative integers by:

$$\begin{aligned} A1 A(0, N) &= N+1 \\ A2 A(M+1, 0) &= A(M, 1) \\ A3 A(M+1, N+1) &= A(M, A(M+1, N)) \end{aligned}$$

Allan's "definition" of the G function contains three strings of dots and the phrase: "The sequence of G operators is easily extended". This looks recursive, as does a mathematical definition of my own:

$$\begin{aligned} \text{For } M \geq 1 \text{ and } N \geq 0 \\ G1 T Gm1 &= T \\ G2 T G2N &= T \times N \\ G3 T G M + 1 (N + 1) &= T Gm (T Gm + 1N) \end{aligned}$$

The "ordinary algebraic expression"

$$A(M, N) = 2 Gm(N+3) - 3$$

is a relationship between two generally-recursive functions; there is no non-recursive algorithm for computing either the G function or the A function for general M and N.

George Miles,
Wyken,
Coventry.

Stretching language

IN HIS article "The limits of my world" in the September 1981 issue, Boris Allan makes two claims: that he has given an ordinary algebraic expression for Ackermann's function, and that this allows us to perform the computation of the function in a non-recursive manner. Neither is justified.

In the first place, "an ordinary algebraic expression using G-operators" is a contradiction in terms. It is as if I set out to demonstrate that a human being can run a mile in less than a minute, by running using a motorbike.

This is not extending the limits of language; it is just using words differently from everybody else — fine for Humpty Dumpty but not very helpful for the rest of us.

As for the second point, Allan offers no evidence. The non-recursive algorithm clue to Guttman he gives makes no use of his equation. That is not surprising since the G-operators themselves are recursively defined — Gm is defined in terms of Gm-1.

It should be made clear, though, that recursion is never necessary in programming. This is pointed out in, for instance, chapter 3 of Wirth's book *Algorithms + data structures = programs*, where there is even an exercise which asks the reader to formulate a general method for translating recursive programs into non-recursive programs.

Incidentally, the distinction between primitive recursive functions and general, but non-primitive, recursive ones is irrelevant here, as Allan would realise if he consulted a textbook on mathematical logic to find out what these terms mean.

Just because recursive programming can, in principle, be dispensed with does not mean that it always leads to inefficient programs; Allan has clearly failed to show that it does so in the case of Ackermann's function. This is, in any case, a poor choice of function for discussion because the limiting factor is not the depth of stacking. It is easy to write a program for which the maximum stack depth in computing A(m, n) is m+1. The real problem is the rapid growth of the function since A(4, 2) is:

(2 raised to the power of 2¹⁶) — 3
which has more than 19,000 digits.

R A Litherland,
Cambridge.

Portmanteau word

ROBERT Bittlestone, "The Chile Experiment", September 1981, is plainly a greater exponent of the portmanteau word than even H Dumpty. Can he give a proof, in mathematical notation — rather than in recursive, self-referential, sociologist jargon — that my Gemini 64K RAM board, which has no "parity bits and error corrections", is not working? It does, always. Of course he cannot; no, Stafford Beer is bluffing.

Chris Blackmore,
Ilminster,
Somerset.

Erroneous factorials

I WOULD like to point out an error in the program to calculate factorials written by Simon Harris and published in your March 1981 issue. The author makes the mistake, whenever a carry occurs, of adding it to the next element of the array to be processed. On the next iteration of the inner loop the carry would be multiplied by N, causing an erroneous result. The carries should be performed after all of the elements of the array have been multiplied by N.

Those who write machine code may like to note that the ZX-80 stores the value correctly if a negative Poke is performed. This is useful when calculating relative jump displacements or storing indices for the index registers.

Colin Mongardi,
Eastbourne,
East Sussex.

Contentious bones

DICK WARN'S article, August 1981 issue, succeeded in combining two bones of contention in one package; Basic versus Pascal, and educational computing. There is little in it to be criticised — if it had been written 10 years ago. It seems to ignore the actual microcomputer situation — Basic is.

The only way Pascal, or any other structured alternative, might become generally acceptable is if the manufacturers of microsystems were to sell their machines with it on board. As long as I, as a school and personal computer user, am buying a machine which comes with Basic as part of the package, it is what I am going to use. Even if Pascal is available as an alternative, it costs more money.

The arguments one reads are interesting and instructive, but they are not really concerned with practical computing. There seems to be a group of people, possibly those with professional computer training, who have not yet realised that computing is passing out of the hands of the professional into the arms of the amateur in terms of quantity of programming.

With regard to educational computing, three main objectives can be set. To introduce pupils to computer programming; to acquaint pupils with the use of microcomputer systems; and computer-aided learning, CAL. Warn's article did not differentiate between these but they do have different major criteria both for hardware and software.

Considering the first, he admits that Pascal is more difficult to learn but suggests, by implication, that pupils may be slightly bewildered, frustrated and baffled by the limitations of Basic. I have not found this to be the case. I teach simple Basic to pupils of ages from 13 to 18 years and my major problem is fighting them off the micro.

Most never reach a stage where they run into the situations described in the article. Few school pupils are bothered by a lack of portability and few of us in schools are going to do more than read

(continued on page 45)

**TODAY'S
BEST
PRICE
PERFORMANCE
RATIO
FROM A
MICRO
COMPUTER
FROM
£1875**
Standard Model 64K RAM/320K DISK



ALTERNATIVE MODEL:
'QD' 700K DISK £2150

SUPERBRAIN

MASSIVE DATA STORAGE FROM HARD DISK

Massive storage capability is available with the 8in. Winchester Micropolis 7MB - 35B Hard Disk from £3500 including a controller to connect directly to your Superbrain. 12 month warranty included in price.

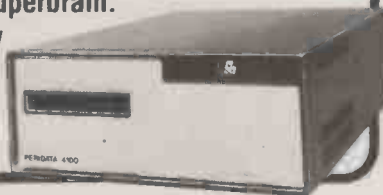

WORDPROCESSING SYSTEMS

A complete wordprocessing system including 'Word Star' and 'Mailmerge', standard Superbrain, Diablo 630 printer, training and up to a day's installation for around £3850.

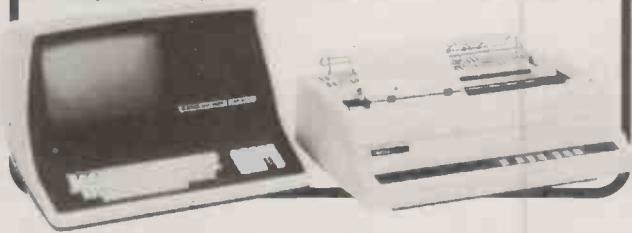

Software Options: we market a full supporting range of standard languages, including . BASIC @ £175, FORTRAN @ £225, PASCAL @ £225 and CIS COBOL @ £425. We have a growing and comprehensive library of software programmes available:

Incomplete Records for Practising Accountants @ £750

Graphics - Hardware @ £435 with Software from £80

Integrated Accounting System - Stock Control @ £350, Order Entry and Invoicing @ £350, Sales Ledger @ £450, Purchase Ledger @ £450, General/Nominal @ £400, Name & Address @ £250, Complete Package so far @ £1650 plus Payroll @ £500.

Financial Modelling - T/Maker @ £155 and Micromodeller @ £645

Data Base Management - DMS @ £400
Word Processing - Wordstar @ £250 and Mailmerge @ £75.

Also available - Form Creation, Debugging etc
Alternatively we will design and implement software packages to suit your specific needs

KGB

MICROS LIMITED

KGB Micros Ltd., 14 Windsor Road, Slough, Berks. SL1 2EJ Tel: Slough 38581

Prices exclude V A T and are subject to fluctuation please phone for an up-to-the-minute quote

● Circle No. 138

(continued from page 43)

about the introduction of new and better hardware. Those pupils whose experience and expertise reach a level where these problems become apparent have also reached a level where they can appreciate the reasons and understand the solutions.

The second objective — to acquaint pupils with micros — has accessibility as its major criterion. I should like all pupils in the school to have had experience of operating a microcomputer before they leave, preferably on a reasonably sophisticated data-retrieval system, but I can see no way in which this can be achieved given present resources.

Most of Warn's article seemed to be concerned with CAL which demands portability and sophistication of software. It also needs the involvement of teachers working in that subject discipline to make sure that the content of the software is as valid as the program structure. However, to return to my initial point, the time for decisions on this was some years ago and those decisions were not taken.

The decision which could be made now is to arrive at some standard of operational software for the 16-bit systems before they are in common use. Until then, CAL will languish partly because of the reasons mentioned in Warn's article and partly because of the lack of resources, time and training, for the in-school production of suitable software.

Philip Bolt,
Kirriemuir,
Angus.

Tandy's flashing cursor

IN ANSWER to Graham Nichol's letter in the September 1981 issue of *Practical Computing* asking why the flashing cursor program for the TRS-80 in the June 1981 issue would not work, I think the fault lies in line 150 of the listing. I altered the line from:

```
00150 RETI
```

to:

```
00150 JP 114D
```

However it is necessary to answer the "Mem size?" query with 32671. After loading the programme, respond to the prompt * ? with /32672. If either of these responses are omitted, the computer will jump back to the "Mem size?" query.

The alteration to the program works with level II although I am not sure why, but it may not work with disc Basic.

J E Barker,
Nottingham.

Pet development project

I AM A computer consultant with substantial mainframe experience and an interest in microcomputer implementations of database management systems. Over the past year or so, I have carried out a great

deal of work on a true relational database-management system for the Commodore Pet, with a number of innovations including a form of virtual memory and other performance aids, and both menu-driven and query language processing.

Unfortunately, my mainframe commitments are now such that I am unable to complete the development of this system and I would be grateful if any interested individuals or companies would contact me with a view to taking over and completing development of the package. Write to me as Cardendale Ltd, 16 Malvern Road, Gillingham, Kent ME7 4BA.

Graham Seel,
Gillingham,
Kent.

Changing Atom group

FROM THE end of September I shall cease to be responsible for the running of the Atom User Group. The group will be taken over by Peter Frost at 18 Frankwell Drive, Potters Green, Coventry CV2 2F8.

Richard Meredith,
Coventry.

ZX-80 Inkey routine

IN REPLYING to the letter from Charles Drayson published in the August 1981 issue, here is a Get or Inkey routine for the Sinclair ZX-80:

```
IN A, 0 : Get port 0 into Ac
LD L, A : Into L
LD H, 0 : Clear H
RET : Back to Basic
```

The following program will load this and lines 20-26 may be deleted after it is run. Line 10 contains the machine code and will not run.

```
10 REM AAAAAA
20 LET A = 16426
21 POKE A,219
22 POKE A+1, 0
23 POKE A+2, 111
24 POKE A+3, 38
25 POKE A+4, 0
26 POKE A+5, 201
```

The statement LET A =USR (16426) will return the value of the key pressed. This routine works best in a short For-Next loop.

```
100 For N = 1 To 100
110 Let A = USR (16426)
120 Next N
```

This allows a larger time slot to detect a pressed key.

M A Myatt,
Bedford.

Economics of design

IT WOULD seem that D L Fisher — Feedback June 1981 — suffers from a stiff neck, lack of perception and ignorance of the engineering economics of designing, producing and selling low-cost micros. Chip count and memory size related to customer cost resistance is where the business starts and stops.

Memory size and speed is the base line which dictates systems implementation and programming. A "professional" programming job which occupies 32K is useless on a 16K machine. The use of multiple statements and the removal of Rems and blanks is often the only way a non-trivial program can be made to fit into, and run, on a micro. Programs are only useful if they run.

Colin Webb,
Dhahran Airport,
Saudi Arabia.

Compucolor inspiration

AS THERE appears to be very little written on the Compucolor II, I would be interested in contacting anyone who owns a Compucolor II to exchange ideas. My address is Grey Court, 3 Stoke Hill, Bristol. I have a Compucolor II Model 3, 8K RAM.

David Johnson,
Bristol.

Teach Yourself review

WE WERE interested to see the review of our book, *Teach yourself computer programming in Basic*, published by Hodder and Stoughton, in the September 1981 issue of *Practical Computing*.

Despite your reviewer's feelings that our book is unlikely "to rocket to the top", it is now in its second printing — more than 10,000 copies have been sold. In the review, it says that the Teach Yourself book owes "nothing to 1980s' micros"; the programs were developed initially on the Commodore Pet and then also run on a mainframe. The intention was to provide programs that would run on most systems supporting Basic, as there are still large numbers of students at Universities and Polytechnics whose first experience of computing is with on-line systems.

Eric Deeson, the reviewer, is right in concluding that our book is not aimed at experienced programmers. The arts of programming and programming techniques warrant books to themselves. Our book is aimed at beginners including non-computer specialists who wish to gain a knowledge of the Basic language to enable them to use a computer in their field.

As a point of interest, having assessed the many Basic books on the market, Commodore approached us to write a similar book for the Commodore Vic containing additional sections on Peek, Poke, colour, sound and high-resolution graphics. This book will shortly be published by Hodder and Stoughton under the title *Learn Computer Programming with the Commodore Vic*.

L R Carter and E Huzan,
Slough,
Berkshire. □

Facit trio designed to keep options open

THE NEW DTC computer system from Facit is available in three versions. Two versions are for business management and one is for colour graphics — all three are based on the Z-80 processor. The graphics version, the Facit 6511, starts at £2,000 excluding printer, but includes a 14in. screen conforming to teletext standards, with 24 lines of 40 characters, and seven colours. There is a dual mini-floppy

unit, providing up to 143Kbyte capacity on each. The 24K ROM-based interpreter has selectable mathematical precision and a time function. Communications interfaces are provided with a programmable transmission rate of between 50 and 19,200baud. One interface is asynchronous, the other offers reverse link-up facilities between synchronous and asynchronous communication systems.

The computer also has an integral sound generator with volume control. An optional high-resolution graphics facility provides 240-by-240 points, each of which can be in colour or white.

The business management computers are the Facit 6510 and 6520. The 6510 has a 10in. screen and a 48K memory, the 6520 a 15in. screen and 64K of memory. There is also a range of software packages available to complement the machines.

Facit has called the packages "positive software" and they include: sales, invoicing, purchase, stock control, nominal general ledger, word processing, Facicalc and DTC register. The Facit computers feature yellow-on-brown screens — apparently they are easier on the eyes.

For details contact Facit Business Systems Division, Wellington House, Wellington Street, Leicester. Telephone: 0533-547149. □



Simple payroll for ZX-81

A SIMPLE payroll program designed for use by a small company has been developed by Hilderbay Ltd for use with the Sinclair ZX-81 microcomputer, together with the 16K RAM pack and printer.

The program will be of use to any company with 30 or fewer employees, who will find the package able to cope with payments, deductions, bonus payments, records and printouts. Hilderbay Ltd is a company which seems to be carving a niche as a provider of software for the smallest of machines.

The complete system will cost the user less than £200, and that includes the computer. The software costs £25 and is complete with step-by-step instructions, a training system if necessary, and a replacement service in case there is new tax legislation.

Contact Hilderbay Ltd, 8-10 Parkway, London NW1 7AA. Telephone: 01-485 1059. □

This is the Husky 144 portable computer for outdoor environments and robust applications. The machine weighs less than 2kgm. and is a little larger than a book. This British innovation is reasonably powerful despite its size — it has a memory of up to 144K. The screen can display up to 128 characters in four lines. Information can be transferred to a main computer from the field via a telephone. For further information, contact David Viewing, managing director, DVW Microelectronics. 0203 56580/27535. □



France looks to the future

FRANÇOIS MITTERRAND, the socialist President of France, is certainly taking an interest in the world of computers and information technology — the "in" phrase for 1981. He has announced his intention to open a world centre for informatics development in Paris at the earliest possible opportunity. This is part of a drive by the French to put their informatics industry at the forefront of as many communication-related activities as possible by 1988.

Mitterrand stated that: "The tools of informatics could be mastered only by thinking on a world scale. France will reinforce its position in all industries related to electronics. The government will do all it can to help small, medium-sized and new companies".

At the other end of the scale, the French Home Secretary has halted computer-produced identity cards on the grounds that they endanger democracy. This is an opinion held by many due to the apparent ease with which a government could form a central file of all citizens. □

Birmingham's launch-pad

BIRMINGHAM City Council is creating a multi-million pound partnership as a launch-pad for high-technology industries in the city. The program will start with the establishment of a science-and-technology development centre, with management, consultancy and scientific services being provided by Aston University.

Under such a program, small companies will have the benefit of a powerful research organisation which they would otherwise not be able to afford. Such an enterprise should create thousands of new jobs as similar programs have done in the U.S.

The science-and-technology development centre is similar to a science park — that is, an area where many high-technology industries are concentrated, together with the resources they require. □

Wider scope with Pascal

TAKING ADVANTAGE of the power of Portable Pascal, IBC's network and resource-analysis program can cope with projects of up to 30,000 activities — but this is limited by the microcomputer used, and the time.

The package will run on Apple II, North Star Horizon, LSI-11, Microengine, Z-80. Future plans include the Onyx, Superbrain, Dynabyte and Cromemco machines. IBC can supply either a complete system or just the software, together with after-sales support. IBC Computer Systems Ltd, Sunderland House, Sunderland Street, Macclesfield, Cheshire. Telephone: 0625-616399. □

Scientist can digitise

A NEW precision analogue-to-digital converter is capable of taking the typical signals a scientist would display on a strip-chart recorder, digitise them and send them to a microcomputer.

Dyson Instruments, Sunderland House, Station Road, Hetton, Houghton-le-Spring, Tyne and Wear. Telephone: 0783-260452. □

Uncommitted logic at an engaging price

MARCONI Electronic Devices Ltd (MEDL) has recently opened a very smart new factory near Lincoln for the manufacture of microchips. As well as making its own custom-designed devices, it has a product which might well be of great interest to the small manufacturer of micros or add-on products. This is a particularly easy and low-cost version of the uncommitted-logic array idea.

MEDL's System 85 is based on standard chips containing up to 1,440 standard logic cells — 2,014 cells will be available soon. Each cell consists of four transistors. This array can be turned into almost any circuit you like by interconnecting the

Olympia fields its strong desk-top team

OLYMPIA IS the latest of the big office-equipment suppliers to weigh in as a manufacturer of desk-top microcomputers. The reputation of Olympia as a major office-equipment supplier will certainly boost its sales — especially to first-time users.

The range of desk-top machines, with both software and hardware, provides for most business uses. The machines are of a standard design with the usual 64K of user RAM, and disc capabilities. One attractive touch is that the computers all have the ability to communicate to larger, mainframe machines.

The new microcomputers are called Boss, and the fully-integrated software packages supplied can be used by anybody. Designed for the smaller business, Olympia expects to be able to sell to departments within much larger organisations.

The range starts at less than £3,000 and there are four machines, all supplied complete with printers. Software packages cover sales ledger, purchase ledger, stock control, payroll and invoicing.

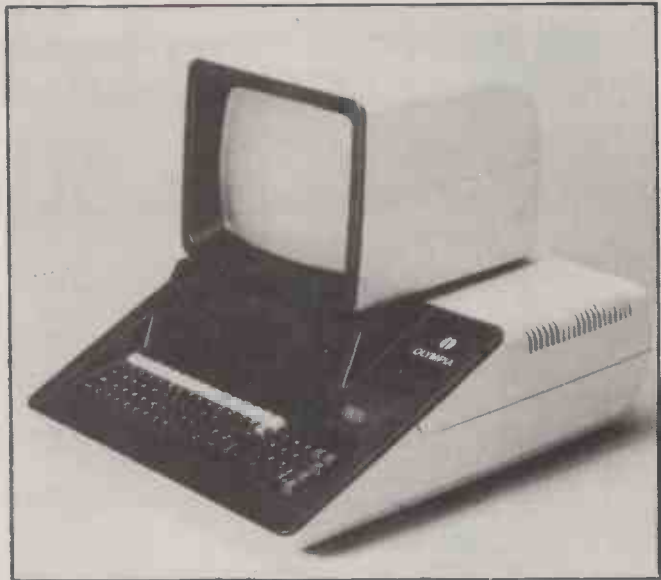

Putting non-expert in the driving-seat

THE PMJH controller is a device which provides extensive control facilities for combinational and sequential timing as well as arithmetic operation using Tiny Basic. The device enables a control system to be developed without any specialised

programming skill. The controller is ready for action with only a 5V supply and a VDU for operator interaction, and the device can act as its own development system.

Systems can be developed and modified while actually controlling — a sure and fast way to debug programs. Work can be effected on site or in the field. Once a program has been developed in RAM, it can be programmed into EPROM by any one of a number of techniques.

The PMJH controller was developed by Manitron at Salford University and was first displayed at a press conference held to protest against the cut in the university's budget of 40 percent. A controller was despatched to Prime Minister Margaret Thatcher, together with a note expressing the hope that this would not be the last such innovation the university successfully transferred to industry.

A fully-populated board with 4K-by-eight RAM and 4K-by-eight EPROM costs £239 for one, with reductions for quantity. Manitron Division, Ficention Ltd, Bold Street, Sandbach, Cheshire. Telephone: 09367-4171. □

cells. To make the job easy, MEDL gives the designer a big picture of the array plus decals representing the usual logic gates.

He just has to stick these on to the photograph of the array to specify his circuit. MEDL will then test it using simulator software.

Unlike earlier uncommitted-logic arrays, System 85's Cellmos is realised in CMOS technology. This means that the finished chip draws very little power and could be used, for example, in battery-powered products.

In effect, the designer is packing the logic which might occupy a whole printed-circuit board into one chip. Since a

printed-circuit board costs at least £2 a package to make and test, MEDL's prices can be attractive: design kit and handbook — up to £355; production of 10 samples £7,000; 1,000 off in ceramic, packaged £17 each.

A satisfactory design which is wanted in quantity can be made as a dedicated chip in the same CMOS technology. The cost would be a transfer charge of £10,000 but a saving per piece in quantities greater than 10,000 units of 25 to 30 percent. Martin Wolfenden, Marketing Manager Cellmos Marconi Electronic Devices, Carholme Road, Lincoln LN1 1SG. Telephone: 0522-29992. □

INNOVATIVE TRS 80-GENIE SOFTWARE

from the professionals

Mysterious Adventure

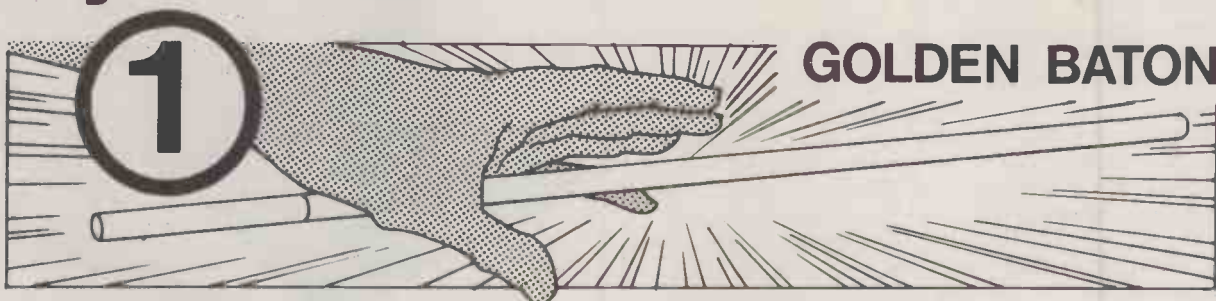

GOLDEN BATON

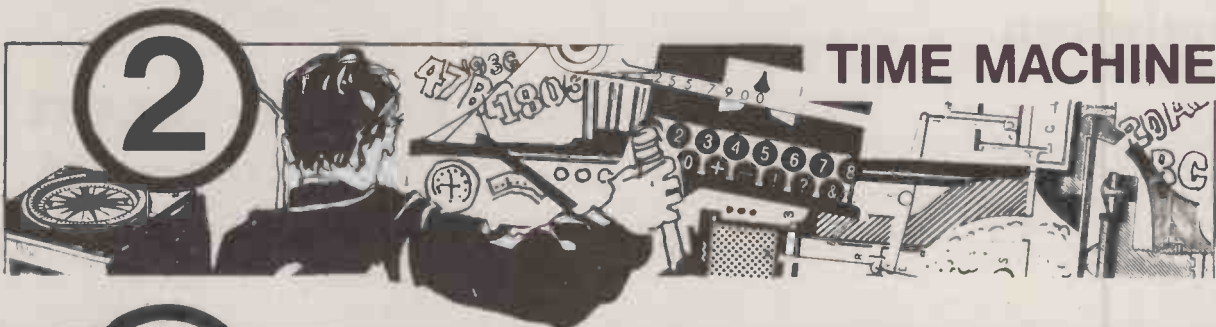

TIME MACHINE

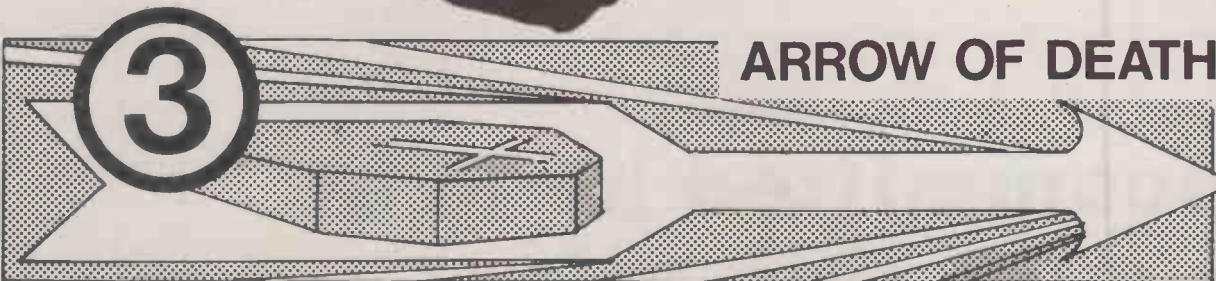

ARROW OF DEATH

Three months ago we introduced the Mysterious Adventure series, a brand new series of machine language Adventures written by Brian Howarth. The first one, The Golden Baton, was greeted with enthusiasm by experienced and beginner Adventurers alike. Now the second and third in the series, The Time Machine and Arrow of Death, are available. The Arrow of Death, although entirely self-contained, is the first of a two part Adventure. The second part will be available early in the new year.

Mysterious Adventures are available for Models I and III TRS-80 and Models I and II Video Genie, both on tape (16K minimum) or disk (32K 1 disk minimum). A TRS-80 Model II version will be available shortly.

Any 1 Adventure:	On tape	£10.06	Any 2 Adventures:	On tape	£18.40
	On disk	£12.65		On disk	£23.00

All prices are inclusive of V.A.T. Please add 50p for P. & P.



MOLIMERX LTD

A J HARDING (MOLIMERX)



1 BUCKHURST ROAD, TOWN HALL SQUARE, BEXHILL-ON-SEA, EAST SUSSEX.

TEL: [0424] 220391/223636

TELEX 86736 SOTEX G



TRS-80 & VIDEO GENIE SOFTWARE CATALOGUE £1.00 [refundable] plus 50p postage.



The North Star Advantage, stand-alone desk-top micro-computer, retails at slightly less than £2,500. The machine is supplied complete with a business graphics package, and includes a Z-80A processor, 64K of user memory, a 12in. monochrome screen, twin mini-floppies and a keyboard with 15 programmable function keys. For full details contact Comart Ltd, PO Box 2, St Neots, Cambridgeshire. Telephone: 0480-215005. 

Word-processing link for CP/M systems

WORD PROCESSOR users can merge records created with the Comsoft DMS system with standard letters created by the Spellbinder or WordStar word-processing packages. These packages will work on any CP/M system and provide a sorting, searching, and mailing system.

Under DMS, records can be created to the user's own specifications; they can then be sorted into order and pre-selected according to several criteria before being merged with standard letters. There are many applications, but the system will be of most use to companies which need to send different types of letter to different clientele.

Comsoft's DMS system is

Any software to declare?

SOFTWARE packages that are approved by HM Customs and Excise for VAT purposes are now available on any CP/M or MP/M computers and most VDUs and printers. The programs, written in CBasic, comprise a fully-integrated set of ledger systems designed by accountants for CP/M.

Business Solutions Ltd, 1 Park Avenue, Ilford, Essex. 01-554 5985/0582. 

available for any CP/M machine and costs £400. For any Commodore system, the same package costs £250 and contains links to VisiCalc, Wordcraft and WordPro. Comsoft Ltd, Great Tangley Manor Farm, Womersley, near Guildford, Surrey. Telephone: Guildford 39665/505918. 

Lid's role in great Apple cover-up

A LOCKING lid for the Apple computer eliminates the danger of prying hands removing or fiddling with the machine's cards. Applelock can be fitted to the Apple lid by any Apple dealer for just £12 plus VAT, or alternatively send the lid to Datron Micro Centre of Sheffield for fitting. A second new offering from Datron is Appleview, a transparent lid which lays bare your Apple's innards. Appleview costs £17.50 plus VAT.

The two products are combined in Appleview plus, which costs £27.50 plus VAT. Datron Micro Centre, 2 Abbydale Road, Sheffield, Yorkshire. Telephone: 0742-585490. 

Alpha Plus reveals Pet's true characters

ALPHA PLUS is a character generator for the Commodore Pet range of microcomputers. It is in the form of a ROM which is connected to the second cassette port inside the case of the Pet. There is also some software and a manual, which rests on the top of the keys.

Alpha Plus is, in effect, four different character sets for the computer. Set one gives U.K. users the long-awaited £ sign, which replaces the back slash, while at the same time retaining all the upper-case letters, numerals and graphic symbols of the original CBM set.

Set two also has the £ symbol and supports all the upper- and lower-case letters, numerals and graphic symbols of the original Commodore second set. Set three is a totally new set of mathematical symbols including symbols for set notation, the Greek upper- and lower-case alphabet, the Roman alphabet, the numerals 0 to 9 including an infinity symbol, as well as graphics characters.

The fourth set comprises various graphics symbols only. They include electronic sym-

bols such as resistors, capacitances, diodes, transistors, as well as games-playing graphics, planes, tanks, helicopters, bombs, cars and space



ships. There is also a series of new horizontal, vertical and diagonal lines.

Alpha Plus costs £69 plus VAT for a 2000 series Pet, and £50 plus VAT for a 3/4/8000 Pets. The manual is available separately for £9. The supplier of Alpha Plus is able to provide custom character sets to order. Contact Computer Rentals, 8 Eastbury Close, Thornbury, Bristol. Telephone: 0454-41560. 

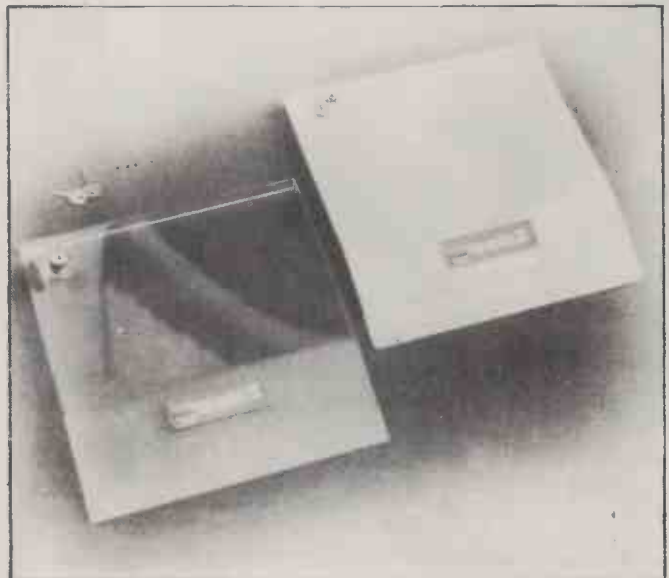

Zilog adds on-chip Basic to its processor family

THE LATEST addition to the world-famous Zilog Z-8 range of microprocessors is the Z-8671. This is the standard Z-8601 microcomputer chip but with an on-chip Basic and a debug/monitor. The chip contains an internal 128bytes of RAM which can be expanded up to 62K by using additional

Modem price talks sense

A LOW-COST, direct-connect Modem for microcomputers has been announced by Spreebond Ltd and is compatible with any micro using the RS-232 interface; adaptor kits are available for the Pet and all the Tandy models.

The £200 Modem plugs directly into the telephone line, eliminating distortions and lost-data problems often associated with acoustic couplers.

Spreebond Ltd, Unit 7, Haslemere, Parkwood Estate, Sutton Road, Maidstone, Kent. Telephone: 0622-683866. □

The Hewlett-Packard HEDS-5000 optical sensing device can measure a motor's velocity, the direction of its rotation and its position. There are 500 measurements per revolution giving the device a resolution of 0.72°. The main use of this device will be in the field of robotics; Micro-mouse fans will no doubt be interested. Celdis, 37 Loverock Road, Reading, Berkshire. 0734-586191. □

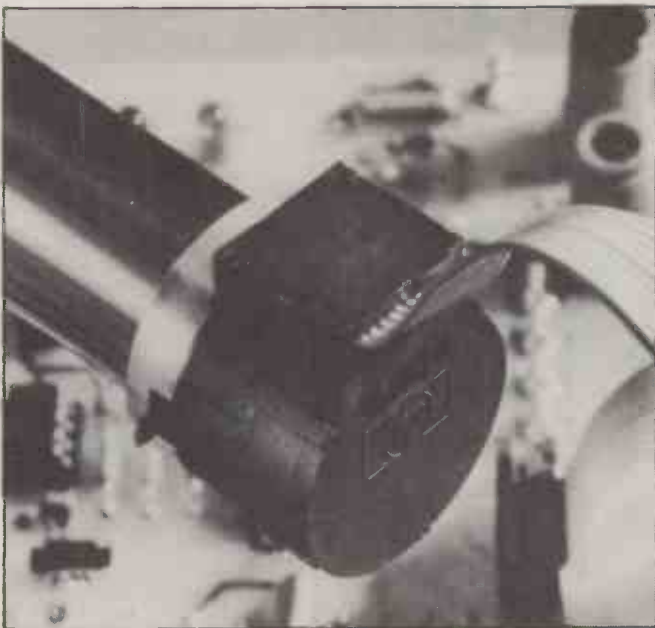

chips. A single Z-6132 RAM will provide an extra 4K of RAM. The only other component required is a power-supply decoupling resistor.

The chip has four eight-bit output ports, an asynchronous port which can be set for baud rates between 110 and 19,200, and various timers. The chip will enable a small system to be built with the bare minimum of components.

The on-chip Basic supplied is a subset of standard Basic, which supports the USR command, allowing assembly-code subroutines to be run direct from Basic. The most likely application of the chip will be in the construction of microprocessor controllers.

Zilog Ltd, Babbage House, King Street, Maidenhead, Berkshire. Telephone: 0628-36131. □

Time for bus systems

THE NATIONAL Semiconductor MM-58174 is a CMOS circuit which functions as a real-time clock and calendar in bus-orientated microprocessor systems.

The versatile device includes an interrupt timer which may be programmed to one of three settings. Other functions include seconds, tenths of seconds, tens of seconds and the same divisions of minutes, days and months. Telephone: Hi-Tek on 0954-81931. □

Government says no to data-protection scheme

THE Government has rejected the idea of an independent data-protection authority, but is to publish a White Paper setting out its proposals on the subject. This was made clear by Home Office Minister of State Timothy Raison at a recent conference held at the British Medical Association, London.

"As the basis of our dome-

stic arrangements, we proposed the establishment of a public register of data applications storing and handling personal information by electronic means", Raison told the conference.

The conference included among its speakers Sir Norman Lindop, who reported on data protection in December 1978 and has argued consistently that any data-protection authority must be independent if it is to have any teeth.

Sir Norman had argued earlier for an independent authority which would enforce a set of "modular" codes which would have the force of law, and would also comply with the principles of the European Convention on Data Protection, to which Britain is a signatory.

A modular approach, where each organisation registering with an independent authority would be assigned particular blocks of rules depending on the kind of data processing and storage activity it was involved with, would be consistent, flexible and compatible for different applications, Sir Norman said.

However Raison, giving the Government's proposals, rejected the independent approach and suggested that "the form of independent authority proposed by Sir Norman's committee is fundamentally objectionable".

In particular, the Home Office resisted the idea that data-protection rules would have the force of law and hence be a major extension of criminal law.

The task was, he said, essentially one for the Government and Parliament — though it was still too early to say when detailed preparatory work on legislative proposals would be completed and a Bill introduced to Parliament.

Raison gave no specific ideas on how the register of applications could work in practice, though Sir Norman's interpretation of the Home Office proposals was that each organisation concerned would "volunteer" itself to register under a set of rules to be derived by itself.

"This is surely a recipe for chaos and disaster", he said. "The Home Office can hardly be said to be impartial and disinterested in the area of personal information". The Home Office is the biggest user of data files on private individuals and is directly responsible for the Metropolitan Police.

Doctors are especially concerned lest confidential medical information fall into the hands of people who have no right to see it. GPs say that computerised medical records may threaten the confidentiality which is the basis of the doctor-patient relationship. □

EXPLORER 85 For Maximum flexibility

A thoroughly versatile S100 based computer

Arrange your own microsystem with the following fully assembled and tested modules

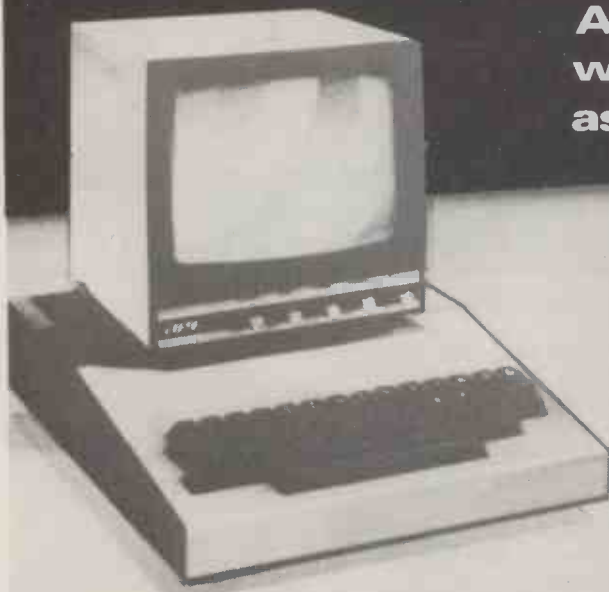

MOTHER BOARD 8085 cpu—3.5MHz 2K Monitor, Cassette Interface, S100 bus connectors and circuitry, provision for ROM/EPROM. £165.00
 AP-1 POWER SUPPLY UNIT 5AMP power supply. £35.00
 KEY BOARD TERMINAL Stand alone, cpu controlled 1K RAM, 64/32 x16 format, 128 character upper & lower case, full cursor control. . £130.00
 64K DYNAMIC S-100 RAM CARD. £175.00
 FLOPPY DISK CONTROL CARD controls 4 drives 2 serial I/O ports 2716 PROM socket. £165.00
 RUNS under resident 8K BASIC in ROM. £65.00
 or with Disk System under CP/M2.2. £95.00

Monitors

NEW 12" Green screen monitor
£150

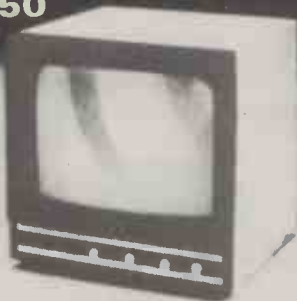

- 10" Black & white monitor.
- Ideal for Apple, Nascom, UK 101 and more **£79.95**
- 10 MHz band width
- Metal cabinet 9" x 9" x 9.5"
- Trade enquiries welcome.

Expansion Cards

SJ64K S100 Dynamic Ram Card
 16K from £130 48K from £145
 32K from £160 64K from £175

S100 SS16K Board
 Add memory beyond the 64K limit
 Expand to a multi terminal system
 Bank selectable **£165**

ELECTRIC MOUTH S100
 "DIGITALK" cards. Give your computer a voice! Complete with loudspeaker. Versions also available for ELF11: APPLE: & TRS-80
ASSEMBLED & TESTED . £99.50
 p&p £2.00

Disks

8" Control Data Corporation Professional Drives

- LSI controller
- Single density 400K
- Double density 800K
- Access time 25 ns **£350**

Controller I/O S100 card

- Up to 4 drives
- 1771 ALSI floppy disk controller
- On board data separation. IBM compatible
- 2716 PROM socket
- On board I/O Baud rate
- Two serial I/O ports
- Generates to 9600 Baud **£165**
- Disk drive cabinet P.S.U. **£79**
- Cable set **£19**
- Coming shortly. Hard disks.

Printers

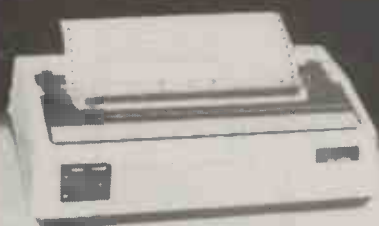

- **Oki Microline £299**
- Serial Interface £75 extra
- **Centronics 737-2 £399**
- **737-4 £429**
- Other models available

ELF 11

A great beginner's computer for as little as £49.95

Ideal for controller systems
 Extra low power RCA Cosmac 1102

- For engineer and industry
- Learn to programme in machine code and really understand computer systems
- Expand it to meet your requirement up to 64K RAM working in basic level 111
- Starters pack - Elf 11 and RF modulator and T. Pitmans short course for **£56.70**
- Expansion Kits. Full Range available. Hardware. Firmware
- Software. Manuals. Send S.A.E. for literature

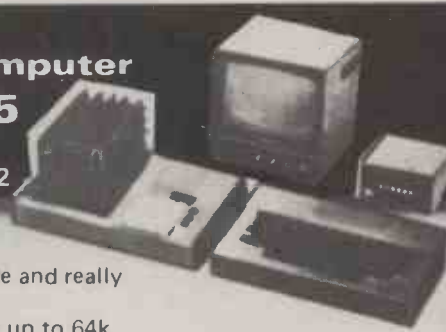

NEWTRONICS

255 ARCHWAY ROAD,
 LONDON, N.6 TEL: 01-348 3325

SEND SAE FOR COMPREHENSIVE BROCHURE

Please add VAT to all prices. P&P extra. Please make cheques and postal orders payable to NEWTRONICS or phone your order quoting BARCLAYCARD, ACCESS number.

We are open for demonstrations and Sales. Monday-Saturday 9.30 a.m.-6.30 p.m. Near Highgate Underground on main A1 into London.

THE REAL COST OF A SHARP COMPUTER SYSTEM

We could simply scream at you 'Get a Sharp MZ-80K personal computer for only £399!'

But you know, and we know, that there's more to it than that. As your interest increases or your business grows, you will want to exploit the unique versatility of your Sharp system - MZ-80K, MZ-80B or PC-3201.

So we thought we would set your mind at rest about the cost of expansion. We print here *all* the prices relevant to system expansion on these three popular and widely recognised computers.

If you think this demonstrates a straightforward and workmanlike attitude on our part, just look at the prices. You will see that they are just as down-to-earth as the rest of our approach.

Butel-Comco support for Sharp users is *complete*. Advice is freely available. Maintenance contracts can be arranged. A wide range of supplies and software can be supplied.



THE BUTEL PRICE GUIDE

Sharp MZ-80K Personal Computer

MZ-80K	Computer 20K. 25cm CRT. Tape cassette. ASCII keyboard.	£399.00
MZ-80K	Computer 48K.	£460.00
MZ-U/G	28K upgrade.	£80.00
MZ-80 I/O	Interface unit.	£82.00
MZ-80FD	Dual disk drive.	£693.00
MZ-80FDK	Additional dual disk drive.	£616.00
MZ-80	RS232 interface.	£110.00
MZ-80P3	Matrix printer.	£395.00
CP/M	Operating system.	£196.00
MZ-80 I/O-1	Universal interface card.	£50.00
MZ-80BM	BASIC manual.	£7.00
MZ-80T10B	BASIC tape.	£9.00
MZ-80T20C	Machine language tape and manual.	£19.00
MZ-80TU	Assembler tape and manual (System Program).	£38.00
MZ-80T40E	PASCAL Interpreter manual and application tape.	£50.00

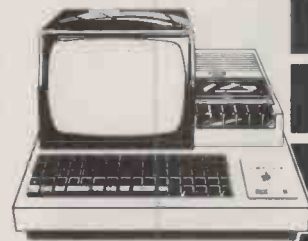

Sharp MZ-80B Personal Computer

MZ-80B	Computer 64K. 23cm CRT. Tape cassette. ASCII keyboard.	£1095.00
MZ-80FD	Twin floppy disk unit.	£590.00
MZ-80FDK	Additional twin floppy disk unit.	£590.00
MZ-80P5	Matrix printer, 80cps. 80col.	£415.00
MZ-80FI	Floppy disk interface card.	£100.00
MZ-80MDB	Master diskette and manual.	£31.00
MZ-80F15	Cable for MZ-80FD.	£9.00
MZ-FO5	Cable for MZ-80FDK.	£7.00
MZ-BCJ	Floppy disk cable joiner.	£15.00
MZ-80EU	Expansion unit.	£50.00
MZ-80GMK	Graphic RAM-II option.	£120.00
MZ-80 I/O-2	Universal interface card.	£45.00
MZ-80T10C	MZ-80K to MZ-80B converter tape.	£7.00
CP/M.	Operating system.	£65.00



Sharp PC3201 Business Computer

PC-3201	Computer 64K. ASCII keyboard.	£1500.00
CE-320C	80x25-character display terminal.	£250.00
CE-332P	80cps, 80/132col matrix printer.	£450.00
RP-1600/5	60cps, 132col daisywheel High-Q printer.	£1495.00
CE-331M	Twin floppy diskette unit.	£670.00
CE-341M	Floppy diskette interface.	£125.00
CE-350L	Additional diskette drive cable.	£30.00
CE-332A	48K RAM upgrade.	£150.00
CE-340R	RS232 interface card.	£150.00
CE-340G	General purpose I/O parallel interface card.	£145.00
CE-350R	Printer ribbon for 332P.	£8.00
	10x5 1/4in diskettes.	£30.00
CE-330G	Direct program generator.	£120.00
	Sales Ledger program and manual.	£300.00
	Purchase Ledger program and manual.	£300.00
	Nominal Ledger program and manual.	£450.00
	Invoicing System program and manual.	£300.00
	Stock Control program and manual.	£300.00



Note: All prices quoted exclude VAT, freight costs and insurance.

All items are available through our fast and efficient Mail Order Service or come and collect it from our 'computer centre' counter. We accept Access and Barclaycard and can arrange Citibank hire purchase. Simply ask for a quotation.

Hours of business:
Mon-Fri 9:30-5:30 and Saturdays
from 9:30 until 1:00.
All prices are correct at time of
going to press.

Call, telephone or write to:
Butel-Comco Limited,
Garrick Industrial Centre
Garrick Road, Hendon,
London NW9 6AQ.
Telephone: 01-202 0262

BUTEL

Technology for business

● Circle No. 141

Revolution of the Rodime disc

Malcolm Dudson of Rodime tells the story behind the development of the innovatory RO-100 series — the 5.25in. disc which offers storage at up to 40 percent less cost than 8in. Winchester.

THE RO-100 series offers up to eight disc surfaces and up to 16Mbytes of storage in a unit no larger than a mini-floppy drive and is interfaced in the same way.

The head/disc assembly of each drive consists of two chambers, one housing the discs and arms, the other housing the actuator mechanisms. The control circuits and the motors which position the heads and rotate the discs are located around these chambers.

Apart from the heads, discs and motors, virtually every component contained in these drives has been designed by Rodime, and designed to overcome difficulties which may be encountered in 5.25in. Winchesters.

In December 1980, when the Rodime drives were still on the drawing board, we decided we could offer the highest storage capacity and the fastest access time which could be reliably designed and produced using the latest components. Therefore, in the RO-100 Series, we have deliberately not used thin-film heads or thin-film discs. When these enhancements have become reliable and are readily available, they will be included.

We took the view that the drive which contains the largest surface area of recording medium will always be able to offer the greatest capacity. From the beginning, therefore, we planned to produce a series of 5.25in. Winchesters which would contain up to four discs while maintaining size compatibility with



the *de facto* industry standard set by drives with fewer discs.

The actuator mechanism has to be of exceedingly rigid design to position the arm furthest away from the bearings accurately. We have chosen a rotary actuator which is more rigid in this aspect than a linear one. Rotary actuators also consume less power, and because there are fewer moving parts, they produce fewer wear particles.

We also designed special shaft bearings and a hub which improves the air flow between the discs. This allows them to be positioned closer together, and improves the air flow within the disc compartment. New head and media technology can be incorporated at a later date without totally re-designing the product.

The RO-100 series offers one of the fastest access times of any 5.25in. drive. The average access time is 85ms, and the track-to-track access time is 18ms. That is

more than twice as fast as the original 5.25in. Winchesters. This access time includes the time taken to find the correct track — the seek time — and the time for the head to settle — the settling time.

The head movements are controlled by a microprocessor. The heads are positioned by a stepper motor, which is controlled by the microprocessor. Among other functions, this calculates the damping required, buffers the incoming step pulses and removes mechanical position hysteresis.

One of the most common causes of errors in disc drives with an open loop positioner, is the lack of adequate compensation for thermal expansion in the arms, discs and other components. We have devoted considerable effort to the choice of metals in the actuator and to the construction of air-flow paths to aid temperature equalisation. Air is pumped from the upper chamber which contains the head/disc assembly, down into the lower chamber where it passes over the actuator linkage, and then back to the upper chamber via an absolute filter.

That ensures that both chambers are always at the same temperature, a feature which dramatically improves thermal compensation for the head actuator. Having ensured this, it is now possible to introduce thermal expansion compensation on a similar principle to a bi-metallic pendulum.

Our design of the Winchester chamber incorporates features which are vital to the efficiency of the drives. Winchester technology relies on a sealed chamber within which the heads fly over the disc surfaces at a very low flying height. In the RO-100's case, this is 17µin.

Here is an example of one of the many important design features of the Rodime drives which contribute to maintaining a completely contamination-free head/disc assembly:

Like all the best design features, it is simplicity itself. Although the Winchester's head/arm chamber is known as a sealed chamber, it clearly has to have a breather filter to allow it to withstand changes in atmospheric pressure. The position of this filter is of crucial importance.

The rotation of the discs causes an

increased air pressure towards the periphery of the discs, and an area of low pressure around the central hub. Now, if the breather filter is placed at the periphery of the disc chamber, this high pressure area is strapped to atmospheric pressure and hence the air pressure at the centre is lower than atmospheric.

The drive bearings are at the centre of the chamber, and the drive motor is always at atmospheric pressure, so that, particularly on start-up, a pressure gradient is created along the shaft of the drive motor which sucks dirt and, more dangerously, grease from the motor bearings into the disc chamber itself.

One answer could be to tighten the bearings. In this case, either the start-up time could be longer, or else more power has to be put into the motor, which would in turn create heating problems, particularly on drives which do not have thermal compensation.

Our solution is both simple and effective. We have located a breather filter at the centre of the compartment, immediately above the shaft. This point is then strapped to atmospheric pressure, and there is no damaging pressure drop.

Many estimates concerning the market for Winchesters have been published in recent months. One of these estimated the 1981 requirement at 500,000, of which approximately 20 percent would be 5.25in. drives. By 1985, the market is expected to have grown to 2.5 million drives, of which 60 percent, or 1.5 million, will be 5.25in. drives. Other less optimistic reports indicate a requirement in 1985 approaching one million drives.

One of the major uses of the 5.25in. Winchester will be in applications where a floppy disc is being used as a systems disc. The fast access times, low cost and small size and high capacity are all added attractions of the Winchester in these areas. Secondly, consider the 8in. Winchester in capacities less than 20Mbytes.

In general terms, in this capacity range, the 8in. Winchester offers the user a cost per megabyte of between \$100 and \$150. In the same range, Rodime's cost per megabyte is less than \$90.

With improved media, both particulate and metallic, thin-film heads, vertical recording, or some of the other exciting recording methods now being developed, giving more than 50,000 bits per inch, it becomes clear that forecasts claiming that the next generation of 5.25in. Winchesters will reach 50Mbytes may even be on the conservative side.

Rodime Ltd are at 12-14 Edison House, Fullerton Road, Glenrothes, Fife KY7 5QR.

The search for a generally-acceptable standard continues, and the answer still seems as far away as ever. Is the time yet ripe for telesoftware?

The Great Standards Hunt

CONNOISSEURS of the "standards loop" will note with a wry satisfaction that the show is getting a grand re-opening this autumn. It is a performance which is expected to run and run.

At the Skyways meeting an *ad hoc* ginger group, mainly of the smaller manufacturers and software houses, got together to urge a new initiative in telesoftware. Now a formal Government committee, ponderously titled the British Videotext Technical Committee, is to re-convene after an absence of several years to thrash out a representative position on standards for the transmission of

by Martin Hayman

software via Prestel and broadcast receivers. It is to be chaired by Bernard Rogers on behalf of the Industry Department and the British Radio Equipment Manufacturers' Association.

One of the committee's objectives is to optimise the British position with respect to transmission protocols. Since it is expected to be representative, we may be sure that the bigger manufacturers will get plenty of say. Since the world is its oyster, we may reasonably speculate that there will be a long search for the pearls of true wisdom.

There is an argument which says that the smaller outfits are in too much of a hurry to implement telesoftware. They should be looking to the future, and the possible introduction of eight-bit technology and all the other enhancements of which Prestel is capable, and should also take greater account of broadcast telesoftware. As it happens, the public is responding with far greater interest to teletext — broadcast information — than to Prestel, which can still only claim 10,000 or so subscribers.

Prestel users are deserting the ponderous and expensive dedicated sets in favour of small-scale adaptors and portable televisions — the kind which you can pick up and take home in the Granada for the weekend. One major manufacturer reports that dedicated Prestel sets are a

dead duck in television retailers' shops. Even at the subsidised Prestel price of over £700, you could well get a decent colour portable plus video recorder. Who is to say that the people who are still watching re-runs of the Test Match highlights and *Emmanuelle Meets the Wife Swappers* are any the worse off than if they had Prestel, except when it comes to finding out the Inter-City train times?

However, I would not sneer at those who are still slogging away at telesoftware. Drafting standards is head-banging work, entirely devoid of the glamour associated with front-line activity, but without which none of it would work. Or at least none of it would work together.

Telesoftware is no new idea. It has been around for almost as long as Prestel itself. Philips, for example, has had a working telesoftware system for a couple of years now. It was demonstrated to me recently by Dr Graham Sharpless, who specified it, and Ludvig Zuidek, who represented Philips at the Skyways meeting. I was most surprised to see a viewdata/micro-type keyboard that looked as though it had been taken off the dealer's shelf. They explained to me that it was the prototype of a Philips personal computer, which had yet to be cased up properly in order to present it to sales staff, who find it difficult to relate to operating systems.

The Philips telesoftware system is fairly similar to GEC's; like theirs, it operates quite successfully with Prestel's own retrieval and update centres, like a normal Prestel editing terminal. It can also call a program from a remote computer, located at the Philips Redhill laboratory, which it will then load into memory. So, as between GEC and Martlesham Heath, there is immediate communication between two parties whose aims are the same and who each know exactly what the other is doing.

"So what"? you may ask. Well, it proves that communications are not an intractable problem when you know what you have at either end. It is when you introduce some new variables that the nightmare starts.

The Philips system uses line and block check-sums and a line terminator in pro-

gram frame. Each frame has a reserved line at the bottom which leads you on to the next frame. This is a useful way of transmitting quite a lot of information. The first field, of two characters, describes the language — unhappily, Philips telesoftware uses DIAB Basic. The second field, also two characters, specifies the version of the language, and the third field, six characters, the memory size required in bytes. The fourth field, eight characters, gives the file name; the fifth gives the number of pages, while the sixth provides extra space to link the program to any data files. These instructions, again, are followed by a check-sum and an end-of-line marker.

Dr Sharpless told me, with the sorrow of an engineer who sees his own creation refused by the powers that be, that he had rather mis-calculated in specifying DIAB Basic. It was his belief that it was a far more powerful and flexible language than the familiar Microsoft version, which he thought was clumsy and, above all, slow. But he had not taken sufficient notice of the fact that the public wants what it can already get, and hundreds of thousands of applications programs have been written in Microsoft for the Apple, Pet, Tandy and so on. So the Philips personal computer never got off the ground, and nor will its telesoftware, likely enough.

Ludvig Zuidek was, incidentally, one of the hawks at the Skyways meeting who argued most strongly that the user of telesoftware would definitely not want to look at the source code of a program, but would merely want to load it as swiftly and seamlessly as possible. He would not be the kind of buff who would welcome playing around and editing code before he could load it into his machine and use it.

I think many people share this opinion, and they may well be right with respect to any other than the hobbyist/amateur markets. In any case, it does rather go towards explaining the excellent facility on the Philips system: a button marked Telsoft which implements the whole loading-up procedure. It is a shame that such an obviously market-orientated machine is unlikely ever to do battle in the market place. 

NEC PC-8001B

Howard Pilgrim and Peter Wood assess the first business micro from the Japanese manufacturer of high-performance hardware, NEC.

WHEN A MAJOR company such as NEC, renowned for quality products like the Spinwriter, launches its own micro, then we all tend to sit up and take notice. The new NEC PC-8001B is certainly an interesting machine with many useful features.

The system consists of a keyboard unit, which houses the micro itself, an I/O box, a double-drive disc unit, a colour video monitor and a small dot-matrix printer. The units come separately boxed, complete with interconnection cables, two reference manuals, and two diskettes.

Actually connecting the components together is one of the most fiddly operations, as there are no less than four data cables, with various types of connectors. A fairly short ribbon cable goes from the keyboard to the I/O unit, which limits the position of the keyboard. We felt this was rather a shame, as a separate keyboard has many advantages in a working environment. Most of the cables bore nasty warnings about disconnection while power was applied, but they seemed to fit

very securely to their sockets and we thought accidental removal would be unlikely.

The I/O box allows interfacing with the disc unit and, presumably, various other devices yet to be disclosed. The printer is cabled directly to the keyboard, as is the colour monitor — black and white may be used instead if required. The I/O unit we were supplied for review is apparently designed for the U.S. market, and we understand that the equivalent to be offered in U.K. will be considerably lower in profile. No problems were experienced in powering-up the system, and with the system disc in drive 1, disc Basic is automatically booted.

The Basic is Microsoft's, as usual, and is called N-Basic. There are a number of commands that appear to be unique to the PC-8001B, and some that other machines have only as optional extras, e.g., a re-number facility. The full list of N-Basic commands is shown in table 1.

We particularly liked the built-in Auto, Merge, Renum and Tron functions, which are similar to the Pet's Toolkit commands. The swap feature is fairly unusual and possibly useful, and Print Using is a very welcome inclusion. The facility to alter the screen width, character sizes and design of patterns via dot graphics proved

both powerful and exciting to use, especially when combined with the Color command.

A spectacular Star Trek game is included on one of the discs which fully utilises these features. While it took some time to load, it was worth the wait. The PC-8001B's random-access file handling is powerful.

Sensitive keyboard

NEC is obviously well aware of the enormous market for micros as intelligent terminals, as demonstrated by the inclusion of the Term command, allowing real RS-232C communications without apparent hassle. We were not so keen on the necessity for Mount and Remove, when loading and unloading diskettes — although it is impossible to forget to say Mount, as disc I/O is not allowed until the disc has been Mounted. It is possible to forget to say Remove before turning off, which could have serious repercussions if data has been written to the disc and the file-allocation table has not been updated via this command.

The error handling provided is very good, having the ability to specify a subroutine for controlled operator intervention with the On-Error-Goto statement. There are, surprisingly, five types of numeric constants possible — integers, fixed point, floating point, hex and octal — and floating-point variables may be single or double precision, which should please all mathematicians.

Overall, we found the system physically pleasant to use; the keyboard is sensitive





and particularly worthy of mention. The cursor-control keys are "upside down" compared with other systems we have been used to — Cursor Up is non-shifted, and Cursor Down is shifted. However, once we were used to this arrangement, it made screen editing far easier as you do tend to be moving up rather than down most of the time when programming and making errors.

The System Re-set button is sensibly hidden on the rear of the keyboard unit, well out of the way of all but the most masochistic of programmers. The general layout of the keys is good — they are standard typewriter QWERTY, together with an additional numeric keypad. Unfortunately the Stop key is immediately above the Return — as it often is — but we assume that Stop could be disabled for any business application. There is an alternative Return button on the numeric pad, which must be useful for those used to calculators, or where pure numeric data is being entered.

The rather large I/O box, mentioned earlier, will be replaced with a somewhat smaller unit for the U.K. market, which will certainly make the system more attractive overall. It does seem a shame that there are so many interconnections, but perhaps mounted in a desk unit the cables could be discreetly concealed.

The disc unit is a little noisy, especially when the fan is running, but no problems were encountered in using it, and we have heard much noisier models. Only 15 files are allowed per drive, which appears to be a severe limitation when comparing the system to its likely competitors such as Pet, but it may be that prolonged exposure to the operating system would show this to be less important than it first seems.

The disc unit contains two 5.25in.

drives, each of 163K capacity. The system disc contains the disc Basic and two utilities — a Copy Disc program for back-ups and a Create program for formatting new diskettes. It would have been good to see more utilities, but no doubt these will appear in due course.

The demonstration disc contains various games, including the previously mentioned Star Trek, most of which show the very versatile graphics and colours well. Since the machine is so new, it is hardly surprising that games are the only programs supplied, though it made it impossible to gauge the performance of the system in a business environment. Certainly, applications software will arrive and it will be very interesting to see how the PC-8001B compares with Apple, Pet and so on in this area.

Clear definition

The Hitachi colour monitor performed well, with clear definition and superb colours. The dot graphics are particularly impressive, and it seems likely that it will be possible to create graphs, pie-charts and other models with good accuracy, using the eight available colours and 690-by 280-dot resolution.

The dot-matrix printer is a NEC product which, while fairly "plastic" in appearance, gives very high-quality output for a matrix unit. The specification claims a print speed of 100 characters per second, which seemed about right. Its bi-directional printing makes quite a difference to overall speed, for instance when making a program listing.

Proportional spacing is also provided, which caused some raised eyebrows until we remembered that NEC makes one of the best-selling letter-quality printers, so the company probably knows what it is doing. A proportional-spacing printer for

around £400 is extremely good value.

Finally, on the hardware side, the keyboard includes five programmable function keys, each of which may be used shifted and un-shifted. At switch-on they are set to various commonly-used statements, such as List, Print, and so on; they may be re-defined by the operator to give a very useful and flexible programming aid. The function-key settings are shown on the bottom line of the screen for quick reference, and change as soon as the Shift key is pressed or released. This display may be turned off if preferred.

The manuals which are provided are well written and, as far as we could tell, accurate. A very handy reference card is also included, containing all the N-Basic statements and a brief explanation of each.

The major work is the N-Basic reference manual, which gives a clear understanding of the Basic, disc files, disc formatting and some operating instructions. The second book is the Expansion Unit Reference Manual, which gives very detailed technical information for the use of Prom chips, Interrupts, using the bus, I/O addresses, Priority Interrupts, Interfacing, etc. Obviously of great use to anyone wishing to delve deeper than simple use of the machine as a Basic system, it was too complex a task to give a fair review of these features in the time available.

One complaint is the lack of an "idiot's guide" to connecting up the system, checking it out and using the Mount, Remove and other essential features. It may be that NEC assumes the system will only be sold with installation and training by the dealer — certainly preferable for all computers — but experience teaches us that this may often not happen.

(continued on next page)

(continued from previous page)

Conclusions

- A neat, professional system in appearance, although cabling seems a little messy.
- Very good-quality graphics and colour, with excellent definition.
- Good, versatile Basic, with some interesting extras.
- Good-quality matrix print from a fairly low-cost printer. The printer may not be sturdy enough for heavy commercial use.
- Apparently restrictive disc-file structure — they have only 15 files per drive.
- Good-quality keyboard, sensibly laid out, with Reset button well out of the way.
- Readable and informative manuals, although an "idiot's guide" would be a welcome addition.
- At present we do not know of any applications programs for the machine, which must severely limit its sales into the business world, though software will obviously appear in due course.
- At around £2,700 for the system hardware as tested, the NEC PC-8001B is competitive, but not cheap.

Table 1.
Statement
AUTO

Description
Generates line numbers after each carriage return.
Causes the internal buzzer to beep.
Clears all variables.
Loads programs from cassette.
Closes previously opened files.
Assigns a colour, or screen attribute.
Formats the screen and determines the colour mode.
Continue after a STOP or END.
Saves programs on to cassette.
Supplies data to a READ statement.
Declares a variable, or range of variables, as integer, single precision, double precision or string.
Defines functions, such as DEFFNB (X, Y) = X/Y*100.
Specifies the start address of a machine-code subroutine.
Dimensions arrays.
Terminates program execution.
Eliminates previously Dimensioned arrays.
Defines error codes not intrinsic to the PC-8001B.
Divides a 256-byte record into fields for a random-disc file.

Statement	Description	Statement	Description
FILES	Displays the disc directory.	ON ERROR GOTO	Sets error trap.
FOR . . . NEXT	Performs series of instruction a given number of times.	ON GOSUB/GOTO	Program branch dependent on value of specified variable.
FORMAT	Performs level-1 formatting of a diskette for data I/O only.	OPEN	Opens a random or sequential data file.
GET	Reads a record from a random-disc file.	OUT	Sends a byte of data to a machine port.
GETC	Saves characters or dot graphics from screen to an array.	PEEK, POKE	Read/write a byte in memory.
GETGC	Saves colour, dot graphics and screen attributes from screen to an array.	POINT	Checks whether a dot is set at a specified location.
GOSUB/RETURN	Causes unconditional jump to subroutine at specified line number, and returns.	PRINT	Displays values of variables and strings, etc.
GOTO	Unconditional jump to specified line number.	PRINT#	Writes image of displayed data to disc.
IF . . . THEN	Conditional jump to specified line number.	PRINT USING	Prints data to a formatted file.
INPUT	Accepts data from the keyboard.	PSET, PRESET	Sets or clears a dot at specified location on screen.
INPUT#	Reads a record from a random disc file.	PUT	Writes content of a random buffer to a random disc file.
KEY	Initialises the programmable function keys.	PUTC	Displays characters and dot graphics previously saved by GETC.
KEY LIST	Displays a list of strings assigned to the function keys.	PUTCA	Displays characters and dot graphics previously saved by GETCA.
KILL	Deletes a specified disc file.	READ	Initialises variables to the data items of a DATA statement.
LET	Assigns a value to a variable.	REM	Remarks.
LFILES	Lists disc directory to printer.	REMOVE	Updates the file-allocation table before a disc is physically removed.
LINE	Specifies screen attributes to a line on the screen.	RENUM	Re-numbers program lines.
LINE INPUT	Initialises a string to an entire line.	RESTORE	Re-sets data items for re-reading by READ.
LINE INPUT#	Reads a line from disc as it was saved by LINE INPUT.	RESUME	Continues program execution after performing an error-recovery procedure.
LIST	Lists program to screen.	RUN	Runs a program in memory, or loads and runs a program from disc.
LLIST	Lists program to printer.	SAVE	Stores a program on disc.
LOAD	Loads a program from disc.	SET	Sets read-after-write and write-protect attributes on a disc.
LOCATE	Positions the cursor at a specified position on the screen.	STOP	Halts program execution.
LSET, RSET	Moves data into defined fields of a random disc-file buffer.	SWAP	Exchanges the values of two variables.
MERGE	Merges a program on disc with program in memory.	TERM	Puts the PC-8001B in terminal mode for communications.
MOTOR	Controls the cassette motor.	TRON, TROFF	Trace on and off.
MOUNT	Reads the disc file-allocation table — FAT — into memory and checks for errors.	WAIT	Suspends program execution until specified machine port sees specific data.
NAME	Re-names a file on disc.	WIDTH	Determines number of characters per screen line.
NEW	Deletes program in memory.		

Decision Modeller can help you increase your profits by 50%!

Don't believe it? This is what the CBI say in their booklet 'The Will to Win':
"Company Profitability is critical for new investment and must be restored. In addition to Government action listed above, all levels of management must be involved in their company's short term and medium term profit plan, and think more in current cost accounting terms when making their judgements."*

*These actions referred to Government controlled costs, exchange rate and public spending.

FACT Company Profitability declined from 13% in 1960 to 9% in 1970 and 2/3% in 1980 when measured in real terms.

Decision Modeller is a tool for all managers to use in their business based on the 1980's microcomputer technology. How many managers know the size of improvement in profits which can result from 1% on Prices plus 1% on Volume of Output? And

- * with 1% off Spending plus 1% reduced Material Waste
- * with 2% on Employee efficiency
- * with 3% off debtors days
- * with 5% on Stock Turnover

Often the improvement in profitability can be *over 40%* and can be as high as *70%* depending on the capital intensity of a business.

Decision Modeller shows you *exactly* how *your* company can improve profitability.

Can you afford to ignore Decision Modeller?

For details call ACT Microsoft on 021-501 2284, or in the London area: Intelligence UK Ltd: 01-947 9846

ACT



To: ACT Microsoft Ltd., Shenstone House, Dudley Road, Halesowen, West Midlands.

Please send me details of Decision Modeller.

NAME:

ADDRESS:

Postcode:

From the people who brought you MicroModeller, the No.1 financial planning package for microcomputers. Decision Modeller costs £525 and runs on the Apple II computer in conjunction with MicroModeller.

● Circle No. 143

MUCH HAS been written in the pages of *Practical Computing* about the desirability or otherwise of structured programming. Comal is really a structured form of Basic. It contains the structures associated with Pascal while retaining the simplicity of Basic. Comal was developed in Denmark by Borge Christensen, so it is not surprising that a Danish computer should have the language as standard.

The computer itself is neat and compact. The system as supplied includes a display unit, a keyboard, the main CPU and a floppy-disc unit. A transformer is also included to provide the correct voltages for operation — the mains supply in Denmark is different to that in the U.K. The system supplied for review only had a single, mini-floppy unit, but other configurations are possible.

After connecting the units together, the next thing to do is to switch on. Experience in these matters makes this the nail-biting moment, but fortunately the Piccolo came on first time. The first surprise was the display, which is yellow on brown. This is the recommended format in Denmark, where all word processors have similar displays.

The Comal systems disc is loaded into the drive and the re-set button is pushed to boot the system. The display then comes up with the message

RC700 COMAL REV.x.xx

and you can begin.

Some rather uninspiring applications software was provided. A little more imagination over demonstration programs would, no doubt, sell many more computers. The more interesting software was annotated in Danish, which is not particularly useful unless you understand the language. The Danish version of Mastermind was the most exciting program supplied, though anybody with a small amount of programming experience can write a Mastermind program, even in Basic.

The operating system used by the machine is not standard, but provides the necessary functions. The re-set switch initialises and starts Comal. Any indentation required by Comal is performed automatically by the software. The system forces all variable names into upper case, with other words appearing in lower case unless they are enclosed in quotation marks.

Comal statements are checked for syntactical correctness as they are keyed in. Incorrect lines are not accepted and an error message informs the user of the nature of the error. This would be a very welcome feature of the language except that, again, the error message appears in Danish. After a while, you get used to the Danish terms, but they are still a considerable handicap in a system which is intended primarily as a teaching machine. The review machine was one of the first to enter the U.K., and the manufacturers say they will amend the software to display

Comal-based Piccolo blows wind of change

The Piccolo is a Danish-built microcomputer aimed at the educational market where it will compete with the Research Machines 380-Z. The main feature of the Piccolo, also known as the RC-700, is the fact that it uses the Comal-80 programming language. Bill Bennett is the reviewer.



the messages in English, not Danish.

The Piccolo's system commands may be used for program development, program execution, dynamic debugging, calculator functions and file handling. System commands run immediately. Usual commands like Auto, List, Load, New, Save, Run and Print are available, and are almost identical to similar commands on other machines.

The RC-700 system uses the command Bye. Con is the equivalent of Cont on other machines; it is the instruction to resume execution of a program after it has been stopped. The command to scratch a file from the disc is Delete "file name", though you cannot scratch the system files. The Help command writes out the names of the commands which are available to the user. The assignation statement Let is included. It has the same function as the Let statement, but is used to assign values before running or continuing a program.

The Look-up command is one that does not appear in most Basics. It replaces some functions of the Catalogue command by returning a list of all the files on a disc. The Output command directs output to either the printer or the video monitor. The command Re-number is particularly useful, and re-numbers all control statements as well as the program lines.

There is an Edit command and special editing keys, as well as control-key functions. The editing functions include cursor movements, character insertion, character deletion, rest-of-line deletion and the deletion of the last input line.

Like other structured languages, Comal is based on the philosophy that the Goto statement is unnecessary. Nevertheless, Goto does remain in Comal, as do most of the commands of standard Basic. Identifiers are used to define certain entities in a program, and may consist of up to 16 characters. An unknown number can be referred to as Unknownnumber in the program. Many Basics allow one or two characters for identifier names.

The possibility of using recognisable words as identifiers makes programs easier to understand. If you read a Comal program written by someone else, it is immediately obvious what is happening. Debugging is relatively easy in a procedure called Taxcalculation, for example, with variables called Income and Deductions. On the other hand, most Basic programs deal with variables such as A, X1, and subroutines are referred to merely by the line number at which they start. This is really the essence of structured programming — knowing what is going on in the program.

Identifiers are given to simple numeric variables, indexed numeric variables, simple string variables, indexed string variables, user-defined functions, procedures, formal parameters, and file variables. Although an identifier can be input

in upper and lower case, it will be forced into upper case once entered.

Most of the commands available in Comal-80 will be familiar to anyone who has programmed in Basic. The RAM statement is retained unchanged, as are many others, such as Print, Read, Input, Data, Restore — which is used to set the data pointer back to the first item in the data list. Goto is retained despite the claims of Comal to be a structured language, as is Gosub.

As in most versions of Basic, the Let statement may be omitted. The Dim statement is slightly different as all strings must be Dimensioned before they can be used in a program. The maximum size of a dimensioned variable is limited only by the available memory.

Def is more or less the same as in most Basics, allowing the user to define functions. The major departure here is that the functions thus defined can have an identifier that actually tells the user what the function does. In most Basic implementations the function would have to be called something pretty meaningless, like FNA for example. User-defined functions in Comal may only have one parameter, and recursive calls are not possible.

Comal allows control of the program to be kept within the limits of certain sub-programs or structures, so it is unfortunate that Comal-80 supports the Goto statement. Proponents of Comal maintain that any program can be written without using Goto, but it is unrealistic to suppose that the statement will not be used if it is there.

Comal has structures to control the flow of the program through gateways such as the conditional statement. This is a more sophisticated version of the If-Then-Else conditional statement — the big bad wolf of Microsoft Basic. For example:

```
1000   if ANSWER$ = "YES" then
2000       exec POSITIVEPLY
3000       else if ANSWER$ = "NO" then
4000           exec NEGATIVEPLY
5000           else exec UNWANTEDREPLY
6000       endif
7000   endif
```

The Else part of the structure may be omitted if it is not required, and the statement list between If and Endif can be as long as is necessary.

The For-Next statement is fairly standard, though it must be properly closed at the end. The While-Endwhile statement, which will be familiar to Pascal users, allows a series of statements to be executed as long as a condition is satisfied.

```
1000   while CONDITIONS = "DANGER" do
2000       exec MONITORPATIENT
3000       exec ALERTDOCTOR
4000       input CONDITIONS
5000   endwhile
```

The While statement, like all Comal structures, is easy to use. The Repeat-Until structure is very similar: the difference is best illustrated by Borge Christensen's statement that the While

structure is a front-door entrance and Repeat-Until is a back-door exit. In other words, a series of instructions is obeyed until a condition becomes satisfied.

The Loop-Endloop can only be left when the Exit statement is reached. The Endloop instruction simply transfers control to the next statement after the Loop command. When Exit is encountered, control is transferred to the next statement after the Endloop instruction.

A procedure is best thought of as a sub-program that may or may not have formal parameters sent to and from it. To call a procedure, the Exec statement is used. Return returns control to the next statement after the procedure call.

In and Out statements are used to communicate with peripherals. One very useful statement is the On Esc command, which transfers control when the escape key is depressed. Randomise seeds the random-number generator, and Output is used to direct the output text to either the screen or another device.

The function set supported by Comal-80 on the Piccolo is reasonably standard, though the file handling is not. Chain is a helpful command which allows another program to be read from disc and executed when the current program has finished running.

The Piccolo Print command is slightly more sophisticated than most thanks to the Tab function and the Print Using instruction. Tab positions the cursor to begin printing at a position on the current line defined by the argument in Tab. The Piccolo has 80 columns on the screen, providing scope for good, clear screen displays.

The machine is weak on graphics. Particular characters provide some screen-control facilities. The codes are more or less the same as in other machines, giving transferred programs a degree of portability. Some codes cause screen flashing — which is very tiring on the eyes — while initiating the semi-graphic character set, inverting the script, underlining and returning to normal script. The printer can be controlled in a similar way.

The Piccolo has been designed with communications and networking in mind therefore it is likely to be this fact as well as the Comal programming language that will make this computer popular with educationalists.

Conclusions

- The Piccolo is a fine piece of hardware, compact and well designed, though it has many cables.
- It will however have to be vigorously promoted to break Research Machines' grip on the education market.
- The Comal language is a useful educational tool, being easy to use and structured.
- Danish error messages are confusing; the software will be greatly improved by removing this problem.

Tailoring the package — and the price

Information storage and retrieval to suit your requirements without the need to program are the big attractions of Compsort's DMS. Peter Wood evaluates the system designed to run on CP/M 2.2 systems.

CP/M IS the most popular operating system for micros, and the wide range of software available for CP/M systems offers the user obvious and attractive advantages. So, it would seem likely that an increasing number of the commonly-used micros will eventually support such an operating system — perhaps in addition to their own more esoteric ones. A recent move in that direction has been the launch of the Small Systems Softbox, a device which allows the Pet to run several of the CP/M packages with no modification whatsoever.

Compsort's DMS has been available for some time on the Pet, and has now been released for use on CP/M version 2.2 machines. DMS, which stands for Data-Management System, is an information storage and retrieval system that the user can configure to his own requirements without recourse to programming. It means the cost of personalised software can be reduced very significantly, providing that the job is a card-index type of application.

The manual provided with the package is well written and informative. While any software product's documentation must assume that the user understands his hardware and operating system — or else be too heavy to lift — this manual goes into sufficient detail to make the task of getting to grips with the program reasonably easy. The style is easy going without becoming trivial and at no time appeared condescending.

We tested the program on an SD Systems MS-20 with 64K of RAM and two 1Mbyte 8in. floppies, running under MS-DOS which is the SD version of CP/M. The program is written in compiled Microsoft Basic and requires 46K of user RAM.

The program is loaded by typing DMS and pressing Return. A menu is then displayed which gives 15 options, each selectable by a single letter, A to N, or X. The user's company name is displayed at the top of the screen together with a licence number and date.

There is also a very user-friendly paragraph describing how to load the various programs, and offering further detailed explanations of them for the inex-



perienced operator. The 15 options are:
A: CONFIGURE B: CREATE C: KEY
D: SHORT E: SELECT F: RE-DEFINE
G: TRANSACT H: REPORT I: LABEL
J: SCREEN K: PROCESS L: COPY M: LINK
N: RESET X: EXIT

As each selection is made, the screen displays the selected program name in large type together with an explanation of its function, and asks you to confirm by pressing the space bar. Pressing E at this stage returns you to the menu screen.

The Configure option allows you to set the program for use with your particular system. The kind of information required at this stage is the type of printer being used — 80 or 132 columns — and the control codes for performing the various screen functions such as clear screen, reverse video and so on. These tend to differ from machine to machine. Configure is used only when you first receive the package and should be run before you do anything else.

Before you can begin entering information, you must, of course, define what you want to store and how it is to be displayed — this is the role of the Create function.

Its job is analogous to setting up a blank record card which is best done first on paper to plan the content and style of the card. The decisions you would need to make are:

- How many fields of information on the card. A maximum of 60 fields are allowed.
- What to call each field, e.g., name, telephone number, etc. Up to 15 characters may be used in the field name.
- Whether the field is character, which means text, numeric — numbers only — or date.
- Decide which is the key field. The information in the key field must be particular to each record, and must be the first field on the card.
- Check that the total length of all the fields does not exceed 1,000 characters, which is the maximum record length.

A worked example of this is supplied in the manual, and provides useful practice for the new user.

In DMS each record has its own key. This key is used for rapid access to the record, as against searching through all the records in the file for a particular piece of information. If, for instance, you had set up a personnel file, the employee's name may well be the key.

Whenever you needed to change the

```

G/81      Records used = 3740
71      Maximum records = 15817

Id name      No.  Type  Length
DESCRIPTION  2    C    30
PLIER ADD1   4    C    25
PLIER ADD3   6    C    25
TERNATIVE SUPP  8    C    5
FIT MARGINX  10   N    10
           12   N    10
STOCK        14   N    10
STOCK LEVEL  16   N    10
    
```

information relating to a specific employee, you could do so by simply typing his name, using the Key option. The computer could then go directly to his record card and retrieve it.

Having selected Key, the first question you are asked is:

Do you want transaction logging Y/N?

If you respond Y, every change you make to the information is copied on to the printer. This is very useful for checking the data you have entered — especially if there is plenty of it. The next question is:

Do you want the contents of new records displayed after keying in data for each field Y/N?

This option allows you to see, on the screen, the entire record card as it is after each field entry. I imagine most users would not use this facility once they have become familiar with the package, since it slows down data entry considerably. Five options are now displayed:

C: to continue without displaying the record after each entry.

D: to display the file description, i.e., the field headings.

R: to re-start the program.

E: to return to menu.

SPACE: to continue.

Having pressed the space bar, you are requested to enter the first field which is the key field. If a record already exists with this key, it will be displayed for alteration. If no record exists, you are asked whether you wish to create a record with that key. You may then proceed to enter information for all the fields on the record.

Two useful features exist at this point. First, if you wish the same information to appear in the same field in the current record as it did in the last, then pressing Control P will duplicate from the last

record being used into the current one.

Secondly, pressing Escape will return you to the first field of the current record, allowing re-entry of data if mistakes had been made. Date fields may be filled automatically with the current date, by pressing C when date is requested.

When records already exist on file, five options are available:

P: Print the current record.

D: Delete the current record.

A: Amend a field in the current record.

S: Store the amended record on file.

C: Get the next record or end.

After amending a record, you return to these five options, and the S is highlighted to remind you to store the altered record. If the change is to be aborted, C may be selected instead.

The obvious and straightforward way of retrieving a DMS record is by Key. The other method is more complex, and ultimately, more powerful — Select. The Select option allows you to search the entire file for information contained in one or more of the non-key fields.

An example may be a personnel file, where you wish to extract all employees who are: paid weekly and; over 40 years of age and; live in Sussex or; live in Sutton. Up to eight criteria may be set on one pass of the file, and each may be joined by using And and/or Or. Confused? — well, it works like this.

First, each selection criterion is allocated a number, 1 to 8. Then each pair of selections — 1 and 2, 3 and 4, etc. — is joined with an And or an Or. Next, each pair is evaluated as true or not-true, giving a maximum of four answers, one per pair. These pairs are then joined with And or Or and evaluated in their turn.

Finally, the results of that evaluation are in turn evaluated giving a final true or not-true result. If this answer is true, then

```

You have the following three options:-
Press A to create a file for WORDSTAR or user program
Press B to create a DMS backup file
Press C to create a file which will update other DMS data files
Press the relevant key (A-C), or 'E' to exit _
    
```

the record is selected and may be printed, displayed or even transferred to another file. A simple truth table can be shown as follows:

```

TRUE      ANDTRUE      = TRUE
NOT TRUE  ANDTRUE      = NOT TRUE
TRUE      ANDNOT TRUE  = NOT TRUE
NOT TRUE  ANDNOT TRUE  = NOT TRUE
TRUE      OR TRUE      = TRUE
NOT TRUE  OR TRUE      = TRUE
TRUE      OR NOT TRUE  = TRUE
NOT TRUE  OR NOT TRUE  = NOT TRUE
    
```

It is certainly a very good idea, as the manual suggests, to calculate all this on paper beforehand so that you are sure that you really obtain the results you expect. The results can be, say, extremely useful reports, once you realise the full potential of this system of selection.

When searching on a Character-type field, each selection can be for the whole

field, or only a position in the field. If you select position, DMS requests you to give the start position and length of the character string by which you wish to search.

If you select the whole field either an exact match for the string or an embedded search is performed on the field. The type of comparison is then requested: EQ, equal to; NE, not equal to; or RN, in the range of. If you select EQ or NE, the next option allows you to compare against a constant, which you supply, or against information contained in another field.

The RN option is more complicated and requires you to type in the two constants between which you want to search. For instance, all records between A and E, or between 678 and 1,999. The last question you are asked is whether you want to see if the constant appears anywhere in the line, so that if you were searching for Sussex, you may wish all records having the word Sussex in the field called county, whether or not they contained East Sussex or West Sussex.

When searching on numeric fields more options are available:

```

EQ equal to
NE not equal to
GT greater than
LT less than
GE greater than or equal to
LE less than or equal to
RN in the range of
    
```

You may compare constants or other fields as in the character searches.

In date fields you have the ability to look for whole or part dates. For instance, you could find information for 1981 or September and range searching is particularly useful for finding dates between two dates. All the selection criteria you enter may be stored on disc for use again and again. The And/Or facility used in combination with the selection criteria described makes the package very versatile and is, in our view, the most significant single feature.

All the DMS reports allow you to use the selection feature and sorted files, and also allow you to choose which fields from the records are printed. There are four types of report.

In the standard report type A, fields from each record are printed across the page with headings at the top enclosed within dotted lines. You may supply a date and title for the report; page numbering and pagination are automatic. Standard report type B is like type A, except that the fields are printed down the page with the headings on the left.

User-defined reports are created using a report generator which allows you to format your printing so that invoices, statements, stock cards, etc., can appear exactly as required. Again, the manual suggests you use pen and paper to set it out before wasting too much time on the machine — and too much listing paper.

User-defined address labels may be

(continued on next page)



(continued from previous page)

printed — you can specify up to five across. Each label can be individual or the same label may be printed up to 50 times.

On each report it is possible to total numeric fields and print them at “control breaks” which are set so that each time the contents of a field changes, say, department number, the totals are printed automatically. Totals for the entire print are also produced.

Three options are used for reporting: A to print standard DMS reports, B to set up tailored reports and C to print tailored reports. Again, you may store the formatted report layouts on disc for future use.

Sorting may be carried out on only part of a file, and generates a sorted index which is then stored. You may create as many sorted indices as you wish, up to the capacity of the disc. When an index is selected, DMS tells you if any updates have been carried out since that index was created. That protects you from missing new information.

One of your previously-defined selection criteria may be used, and the sort will apply only to records chosen on that basis, so that sorting all employees in Sussex into ascending salary order is very easy indeed.

If you are sorting on a character field, you need not sort on the entire field, but specify the start position and length within the field of the sort criterion. The full contents of date and numeric fields are always used, however.

Having created a sorted index, selecting Screen allows you to make an entry that DMS uses to position itself in the index. The record nearest to the data you entered will then be displayed. It is then possible to nudge up or down the file using the less-than and greater-than keys, print the displayed record using P, or change the search parameter with R.

Obviously, using Screen and Sort is useful only if the index is up to date, and users who change the contents of their files frequently would need to regenerate sorted indices reasonably frequently.

The process function is a batch-processing facility which allows a series of calculations to be performed on all or part of the file. An example may be a stock file, where you needed to increase the price of all items in a particular product group by 10 percent. Again you have the ability to store the process instructions on disc for

repetitive use. The following operations are possible:

- + addition
- subtraction
- / division
- * multiplication
- = make equal to

These operations are performed on fields from the records, accumulators or constants. Up to eight instructions may be entered, each of up to 100 characters in length. In our example relating to stock records, you may set up the following:

1. SELLING PRICE = SELLING PRICE*
#1.1
2. COMMENT = PRICE INCREASE DUE
TO DOLLAR FLUCTUATION

There are 30 accumulators which may be used to produce totals. They are divided into three groups: 1-10 which are cleared to zero as each record is entered before processing begins on that record; 11-20 which are also cleared to zero, but only after processing the record and non-zero accumulators are printed out; 21-30 which are cleared to zero only at the beginning of a processing run, and are printed at the end of a run for end totals, etc.

All the instructions are evaluated from left to right, so you need not remember the precedence of division, multiplication, addition, subtraction. Records may also be deleted by including an up-arrow sign, followed by Delete in a processing line. Processing instructions appearing after that line will, however, be ignored.

You may opt to print the complete record contents both before and after processing, or only after, or only those fields affected by the processing. Errors can also be printed — for example, trying to insert too large a number in a particular field.

A lovely feature of the program is the file-to-file copy. It allows you to define a new, and possibly different, record format, with perhaps more or longer fields and copy all or part of the old file across. The saving on re-typing because you changed your requirements is tremendous.

You may also want to combine the contents of two files, or to extract records for one file into another because you are forming a new company or division. The options available must be obvious by now, as DMS is consistent throughout. Printing options are available, as are selection criteria.

The Link option is used to create files for use with word-processing software, such as Wordstar, and many be used in a mail-merge run, for automatic insertion of names and addresses and so on. It is also used for creating back-up or update files for re-input to DMS itself.

The option exists to use a sorted file which you have previously created, and a pre-defined record selection as with many of the other sections. You may then specify which fields you wish to transfer to the output file.

Up to 60 fields may be output, in any order, and the same field may be output more than once if required — very useful for those involved in direct mailing and personalised letters.

The ability to define a screen mask is important if you wish the information to be presented in a special format, or if you wish to allow updating of certain fields only. It will also allow you to hide certain pieces of data. The Transact feature permits you to create screen masks, each with its own password, so that an operator with the key word can perform his specific task and no other.

If you had a stock-control system where you wished to protect the prices, minimum stock levels, etc., but wanted to allow an operator to issue stock and have the figures for the item updated, then Transact will do the job. Formatted masks may be stored on the disc, and called up by name. The password must then be entered before any processing can take place.

Fields may be updated as the operator is prompted by the system. If a disc is created for use in, to quote the manual, “a restricted-access environment”, then the other menu options can be removed to prevent alteration of the data.

Re-define allows you re-define or print the file definitions — most useful if you need to change the name of a field or fields without altering the record structure.

Conclusions

- At £400 DMS on CP/M is certainly good value. The features offered make it a very powerful records-management package.

- Although the screens were extremely user-friendly in showing a paragraph or so of instructions, we felt this might have been better replaced with a help facility. This would have avoided filling the screen with what becomes superfluous information as the user learns the system. This is, however, a minor point.

- The search facilities are very complex, and when coupled with sorts, file-to-file copies, formatted screen masks, and process options give a very flexible package indeed.

- Compssoft Ltd is at Great Tanglely Manor Farm, Woneresh, Near Guildford, Surrey. Telephone: 0483 505918/39665. The contact is Heather Kearsley. 

SUPER 1K Countdown for Christmas
INVASION ON YOUR ZX80 & ZX81

3 LEVELS OF PLAY IN EACH GAME

From easy to dangerously difficult — you'll find it hard to resist the challenge time after time!

TOTALLY FLICKER FREE

Absolutely no flicker. You don't need to press any thing for the display to move!

MACHINE LANGUAGE

These programs are written in the computer's own language — only this way is it possible for continuous, flicker free action to occur.

MOVING GRAPHICS

No hardware modifications are necessary to get moving graphics. Just follow the instructions for cassette loading and off you go, no extra memory needed.

FITS 1K BASIC MACHINE

Amazing as it is, all these moving graphics programs fit into your basic 1K Sinclair!

ALL PROGRAMS ON CASSETTE

Loads just like any other program on cassette. Each tape contains instructions on how best to load the cassette.

SUPER INVASION

is the machine language game you and your Sinclair have been waiting for. Cruel and crafty invaders have been spotted in battle formation ready to attack with your ship just below them! Quickly and skilfully you shift right and left as you carefully fire your lasers at them. But watch out — they are accurate! 3 levels from easy to almost impossible to beat.

3 LEVELS OF PLAY **£6** **MOVING GRAPHICS**



£6 **DOUBLE BREAKOUT**

You'll be amazed to see how difficult it is for you to break through the ZX80 **DOUBLE BREAKOUT** and even more astonished to see the exciting game fit into your 1K Sinclair. Try your skill on the easiest level because even with the most skilful bat control you'll find it hard to catch at the fastest level! Breaking through the first barricade is easy but don't be fooled for the second — it's much harder than you think! Two ball angles and curved bat will keep the excitement going for hours!

Gobble MAN

Watch out behind you! As you hurry through the maze collecting your energy modules you score points. But don't let the Gobblemen catch you. If you are crafty, sneak up behind them and neutralise them to gain extra points. Just keep a watch. When they attack you they come in fast. Just don't lose your nerve.

TRS 80 Levels I & II 16 K Tape £10
Video Genie 16 K Tape £10



TRS 80

ATTACK FORCE

Dodge the alien Ramships and fire missiles to destroy them before they get you. The alien Flagship uses his deadly laser bolt to transform a Ramship into another Flagship or into your ship's double. Look out! Destroy your double and you could destroy yourself.

TRS 80 Level I & II 16K Tape £10
Video Genie EG3003 16K Tape £10

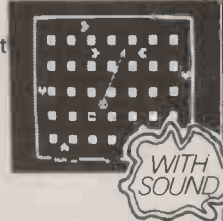

GALAXY INVASION

The newest and most exciting invaders type game yet! Cruel and crafty aliens attack Earth. You are the sole defender. As you fire your laser at the aliens they swoop down and bomb you. Exciting use of graphics! Must be seen.

TRS 80 Level I & II 16K Tape
Video Genie 16K Tape

Video Genie

The Game That Talks
Robot Attack

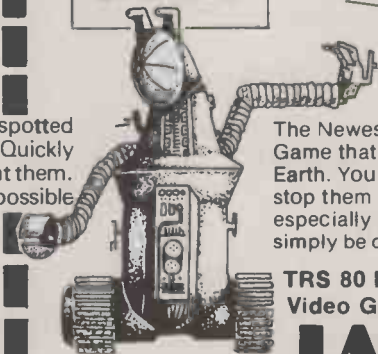

The Newest and Most Astounding Arcade Game that TALKS has just Reached Planet Earth. You can't help yourself. You have to stop them at all cost. Don't let up. Written especially for high quality graphics you'll simply be dazed and excited by the action.

TRS 80 Levels I & II 16 K Tape £10
Video Genie 16 K Tape £10

LABYRINTH

DEATHMAZE A must for all adventure addicts!

Walk down corridors depicted in full Look around to find the objects you need to survive. But beware! Monsters and Incredible Obstacles can lurk round every corner!



for TRS 80 LEVEL II 16K **LABYRINTH TAPE £10**
DEATHMAZE TAPE £10

THE ESSENTIAL SOFTWARE COMPANY (Viscounti Ltd.) 01-837 3154
 47 BRUNSWICK CENTRE LONDON WC1N 1AF

Name
 Address
 Postcode

I have a microcomputer
 Please send me your software catalogue. I enclose a stamped self addressed envelope.
 Please send me
 I enclose a cheque/postal order for £ (plus 50p post & packing)

My ACCESS No is PC 12/81

TANGERINE APPROVED SOFTWARE FOR MICROTAN

MICRO TANTEL SOFTWARE	MICROTAN COMPANION BOOK 2ND EDITION	HIGH RESOLUTION GRAPHICS SOFTWARE
<p>MICRO TANTEL IS A SOFTWARE PACKAGE WHICH INTERFACES TO TANTEL UNITS AND YOUR COMPUTER. THE MOMENT YOU CONNECT YOUR COMPUTER TO THE TANTEL UNIT YOU GET FULL COLOUR FACILITIES WITH A SCREEN SIZE OF 24 x 40. FETCH AND SAVE PRESTEL PAGES INTO USER RAM AREA. UPDATE AND DISPLAY PAGES IN ANY ORDER AND AT ANY TIME.</p> <p>EPROM OR TAPE£19.95</p>	<ul style="list-style-type: none"> * DISCOVER THE INSIDE WORKINGS OF MICROTAN BASIC * PAGE ZERO POINTERS INTO BASIC * NOW LOAD MORE THAN ONE PROGRAM INTO STORE AT ANY TIME * CREATE AND ADD YOUR OWN COMMANDS * DISPLAY THE REGISTERS WHILST YOUR PROGRAM IS RUNNING * IMPROVE DATA RESTORE ROUTINE * FULL VDU MEMORY MAP WITH HEX PLUS DECIMAL VALUES PLUS FULL GRAPHICS CHARACTER CHART * PROGRAM WITHOUT SCROLLING TEXT <p>AND LOTS MORE£9.95</p>	<p>THIS SOFTWARE PACKAGE WILL ENABLE YOU TO USE THE NEW FACILITIES OF THE TANGERINE HIGH RESOLUTION GRAPHICS BOARD. THE PACKAGE CONSISTS OF 38 NEW COMMANDS WITHIN BASIC WHICH WILL ENABLE YOU TO USE THE NEW BOARD WITH EASE. NOW MIX CHUNKY GRAPHICS WITH HIGH RES AND ALPHA.</p> <p>TAPE£12.95 EPROM£14.95</p>
TOOLKIT	2 PASS ASSEMBLER	FILE UTILITIES
<p>APPEND LOAD TWO PROGRAMS INTO STORE NOW</p> <p>HEX CONVERSION FOR THOSE POKES</p> <p>PLOT COMMANDS FOR GRAPHICS SINGLE KEY COMMANDS</p> <p>FIND AND DISPLAY LINE NOS OF ANY VARIABLE</p> <p>AUTO NUMBERING NO MORE TYPING IN OF LINE NUMBERS</p> <p>RENUMBER RESOLVES ALL GOTO'S, GOSUB'S, THEN'S, ETC.</p> <p>EPROM£22.50</p>	<p>AVAILABLE IN 2732 EPROM FOR INSERTION INTO J2 ON TANEX OR OUR 8K EPROM EXTENSION BOARD.</p> <ul style="list-style-type: none"> * FULL SOURCE CODE EDITING FACILITIES. * CASSETTE ROUTINES FOR SAVING CODE. * ASSEMBLY FROM SOURCE CODE HELD IN STORE OR ON TAPE. * ALL STANDARD 6502 OP CODES + LABELS OF UP TO 6 CHARACTERS. * HEX, DECIMAL AND CHARACTER CONSTANTS SUPPORTED. * ASSEMBLY — LABEL — LIST — PRINT * RELOCATABLE ASSEMBLY FOR EPROMS. <p>FULL DOCUMENTATION ...£34.95</p>	<p style="text-align: center;">MENU</p> <p>1 = LOAD DATA FILE 2 = DISPLAY DATA FILE 3 = CREATE/SAVE FILE 4 = UPDATE DATA FILE 5 = SAVE UPDATED FILE 6 = END (OR USER PROGRAM)</p> <p>BASIC TAPE£9.95</p>
TANEX 8K EPROM BOARD	TEXT PROCESSOR	EPROM PROGRAMMER
<p>THIS BOARD PLUGS INTO J2 ON TANEX AND ALLOWS YOU TO SWITCH FROM ONE SET OF EPROMS TO ANOTHER. BY THE USE OF A MECHANICAL OR LOGIC SWITCH THE BOARD CAN BE ORDERED TO CONTAIN 2 x 2732 EPROMS OR 4 x 2716 EPROMS£24.50</p>	<ul style="list-style-type: none"> ● Full screen editing with cursor controls. ● Two-speed two-way scrolling. ● Global search function. ● "3 levels of operation" ● 1 operate on complete text. ● 3 operate on selected line. ● Create and maintain text files with fast loading. ● This is a machine code program on tape. <p style="text-align: right;">£19.95</p>	<p>CHEAP SOLUTION TO 2716 EPROM PROGRAMMING USING THE COMPUTER TO DRIVE THE PROGRAMMER. THE CIRCUIT PROVIDED CAN BE BUILT ON VEROBOARD AND CONNECTED TO TANEX PORTS VIA CABLE AND 2 PLUGS. WE PROVIDE THE CIRCUIT AND THE SOFTWARE</p> <p style="text-align: right;">£9.95</p>
CHESS 2	ADVENTURE NOW AVAILABLE FOR MICROTAN	<p style="text-align: center;"><i>SEND CHEQUE/POSTAL ORDER PLUS 50p POST AND PACKING TO:</i></p> <h2 style="text-align: center;">MICROTANIC SOFTWARE</h2> <p style="text-align: center;">235 FRIERN ROAD DULWICH, LONDON</p> <p style="text-align: center;">or tel 01-693 7659</p> <p style="text-align: center;">PRICES INCLUDE VAT</p>
<p>AN AID TO CHESS PLAYERS</p> <p>1 NEW GAME SET UP</p> <p>2 GIVEN POSITION SET UP</p> <p>3 CASSETTE STORED SET UP</p> <p>RECORD AND RETRIEVE MOVES</p> <p>FROM CASSETTE£8.95</p>	<p>£5.95</p>	
<p>GAMES 1£8.95</p> <p>MOON LAND HANGMAN OTELLO (B)</p>	<p>GAMES 2£8.95</p> <p>ONE ARM BANDIT DICEY DICE HOT SHOT (B)</p>	
<p>GAMES 3£8.95</p> <p>BREAKOUT NOUGHTS & CROSSES TANKFIRE (B)</p>	<p>GAMES 4£8.95</p> <p>PONTOON HANGMAN SLOXO (M/C)</p>	

● Circle No. 145

Analysing data

STATISTICAL PROGRAMS are published in two very different forms in the two packages reviewed here. Prentice-Hall offers a series of simple programs as listings in a book, while Ecosoft's Microstat is supplied on a pair of discs.

Basic-pack Statistics Programs for Small Computers is a recent addition to the Prentice-Hall series in personal computing. It contains a selection of 33 programs for statistical analysis of data. Each program is separately documented with a clear description of its purpose, its possible uses and the kind of data for which it is designed. Worked examples and detailed instructions are given, so a relative beginner could pick up the book, key in a program and begin analysis within half an hour.

Most of the programs deal with a single test, though some of the more elementary routines such as mean, variance, standard deviation and standard error are grouped into one program. The programs are typically 100 to 180 lines long.

Since all lines are single statements, and many are taken up by Rems or the single command Print, only a small amount of typing is required to enter a program. However, if you need to carry out several different tests on the same set of data, it is necessary to re-enter the data for each test. With large runs of data this could be tedious and a source of error.

The programs give you full opportunity to correct data that has been entered erroneously. They also inspect the data as it is entered and prevent entry of invalid data, such as negative or out-of-range values.

By looking through the book and finding a worked example that parallels your own set of data, you can find and run a suitable test without having much understanding of the statistical principles involved. For those who do want to get to grips with the principles there are very detailed explanations of each test, which include a description of all the underlying equations and concepts. The explanations are backed up with a list of references to fuller descriptions in the standard American textbooks, some of which are readily available in U.K. Each program is also accompanied by a set of exercises, with answers, thus making the book useful to the student.

Full running instructions are given for each program, together with printout of one or more sample runs. Under the heading "Bugs", the author lists any circumstances under which the program may fail to operate satisfactorily, such as the possibility of overflow when calculating factorials.

Tables of Student's *t*, the Mann-Whitney *U*, chi-square, and Fisher's *F* are given at the back so that the user can estimate probabilities from values of these statistics calculated by the programs. A few of the programs calculate the probabilities directly.



Two contrasting sets of statistics programs are examined in detail by Owen Bishop.

The author comments on the reliability of the algorithms used. Rather tantalisingly, he does not explain the basis of these algorithms, which would interest the more erudite statistician. It is only in these programs that the Basic uses more than the most elementary of operators and functions. The owner of the typical personal computer should be able to key in most programs without much adaptation.

The book begins with a set of 10 programs on descriptive statistics. These include calculation of probabilities under the binomial, Poisson and normal distributions. There are utility programs for sorting and ranking an array of values, and programs based on the *t*-statistic and on chi-square.

The remainder of the programs, which include the McNemar test and the Median test, reflect the emphasis on non-parametric testing found in this collection. Since non-parametric tests are best for small samples — which is what most of us usually have to deal with — the selection offered will be generally useful. The most notable omissions are analysis of variance and regression analysis.

The book is well produced with large, clearly laid-out pages. In each chapter, the printout of the sample run and the listing of the program are in facsimile to distinguish them from the descriptive text. Unfortunately the original printout and listing appear to have been done on an ancient printer with a worn ribbon. Although legible they are not easy reading. This, however, is a minor criticism of what is generally an excellent work.

The Microstat package from Ecosoft is a product of an entirely different type. It

is clearly aimed at the experienced statistician who has a suitably impressive microcomputer on which to run it. The manual states that the minimum system for satisfactory operation should have 32K memory and dual single-density 8in. disc drives.

The package is presented on two discs, one of which is completely filled with programs. The other carries the remainder of the programs, leaving about 280 blocks of free space for the storage of data files. The discs are designed for operating under North Star DOS and Basic. There is provision for establishing certain screen and printer parameters once and for all so that the format of VDU display and printout can be adjusted to the peripherals in the user's system.

The package is based on a data-management sub-system — DMS — in which all data is held in files. There are all the usual facilities for creating, editing, merging and destroying files. The convenience of the DMS is that data needs to be entered only once. It can then be subjected to a variety of statistical procedures as often as required, for as long as it remains on file.

There are also procedures for transforming the data in a file. For example, by a single command every item in a named file can be converted into its reciprocal or its natural or common logarithm, multiplied by a constant factor, incremented or decremented by a fixed amount or transformed in a number of other ways. This is an essential preliminary to several statistical tests and can be helpful when one is looking through a set of data prior to

(continued on next page)

(continued from previous page)

analysis. Sets of data can be displayed with all variables in a common format, independent of the format in which they were originally entered.

Access to the package is by means of a sequence of menus. Selection and branching is by single-key entry, with the default being the choice most commonly required. Progress through the stages of a procedures can be very rapid, though the less-experienced user could quite easily become lost.

Unfortunately, there seems to be no way back to the main menu until after the completion of each test. A careless entry during a test can lead to a waste of time, while you plough on through the remainder of the test watching the results of meaningless computations appear on the screen. This package is clearly for the careful and concentrating user.

There is a comprehensive selection of tests, both parametric and non-parametric. These include analysis of variance, regression analysis, time-series analysis, goodness of fit, the runs test and most other standard non-parametric tests. There are programs for calculating factorials, permutations and combinations. These calculate factorials directly for $X \leq 49$. Above this limit, approximations are used to eliminate the danger of overflow. The upper limit is factorial 1,000,000.

The manual is well compiled and explicit. It contains clear instructions on how to operate the system, and lists the menus and the sequence of entries required for performing each of the tests. There is no attempt to make this a statistical handbook. Unlike the Prentice-Hall book, the Microstats manual does not explain the purpose of the tests, nor does it give examples of their use or show what they do and how they do it.

The programs have no provision for preventing a test being performed on invalid data and calculating entirely meaningless results. This is not necessarily a criticism of the programs, for they are clearly intended for experienced users, but the less experienced should not contemplate using the Microstats package without considerable preliminary training.

One aspect of data entry was found to be inconvenient and a cause of frequent mis-keying. The problem arises because data must be entered by cases. For example, when entering a table which lists the weights, ages and response times of a set of persons, the data must be entered person by person. Every figure to be entered has a different format from the figures preceding and following it. You might have to enter a series such as 85.35, 42, 0.0123 for each person, though it would be much easier to enter all the weights, followed by all the ages and all the re-

sponse times. Keying in a set of values with identical format establishes a rhythm, and is quicker and less error-prone. This facility could have been provided without unduly complicating the program, and would have made data entry more speedy and reliable.

Conclusions

● The Prentice-Hall book is good for descriptive statistics, and non-parametric testing. It gives clear and full explanations throughout, and is suited to the beginner and student as well as to the more advanced user of statistical testing. It contains short, clearly-written programs which use a fairly elementary Basic set. It is highly recommended as very good value for money at only 33p a program.

● The Ecosoft Microstat is a worthwhile package, though only for the expert. You will need to follow its system exactly, so look at the manual before buying the discs, to confirm that the procedures and the range of tests suit your requirements.

● *Basic-pack Statistics Programs for Small Computers* by Dennie Van Tassel is published by Prentice-Hall International, price £11; ISBN 13 066381 6.

● Microstat is produced by Ecosoft, P.O. Box 68602, Indianapolis, In. 46286, U.S.A., and distributed in the U.K. by Digital Devices Ltd., 134 London Road, Southborough, Tunbridge Wells, Kent; telephone (0892) 37977/9.

CAMBRIDGE COMPUTER SHOW

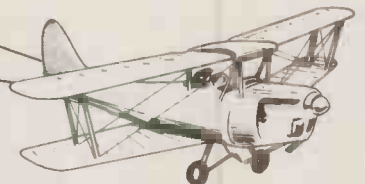

Micros have really taken off in Cambridge!

- TRS-80 Model II & III
- Apple II & III
- North-Star Horizon
- Communicator
- Commodore Pet
- Daisy-wheel printers
- Computer books
- Acorn Atom
- Hewlett-Packard HP85
- UK101 kit computer
- Sharp pocket computer
- Wordstar/Datastar
- Plotters/digitisers
- Electronic components

First time buyer or experienced user? See what's best in microcomputers today, all generally on demonstration and available from stock at

Cambridge Computer Store

1 Emmanuel Street Cambridge CB1 1NE
Telephone (0223) 65335/4

Mon. - Fri. 9.00 to 12.30, 1.15 to 5.30
Sat 9.00 to 5.30

● Circle No. 146

SEE US
AT COMPEC
STAND 3198/197

MICROLINE
82A

We've raised the standard but not the price.

The new Microline 82A raises X-Data's price/performance standard higher than ever. At no extra cost.

Based on Oki's superb engineering tradition, the Microline 82A is the result of a continuous development program aimed at providing highest performance at lowest cost.

Unbelievably at the same price as its best-selling predecessor, the Microline 82, it offers:

- Speed — 120cps
- Clarity — 9 x 9 matrix
- Throughput — enhanced logic seeking
- Style — true descenders
- Convenience — rear and bottom paper feed

The Microline 82A will challenge any other printer available in this price range. With Oki engineering to give total reliability.

And it has a sister — the wide-carriage Microline 83A — which offers all the facilities of the Microline 82A with a full 136-column carriage.

Plus lower cost. We've reduced the price by 15 per cent compared with the Microline 83.

Price/performance is X-Data's winning theme. Ring Jane Lindsay at Slough (0753) 49117 for further details and prices or the name of your nearest dealer.

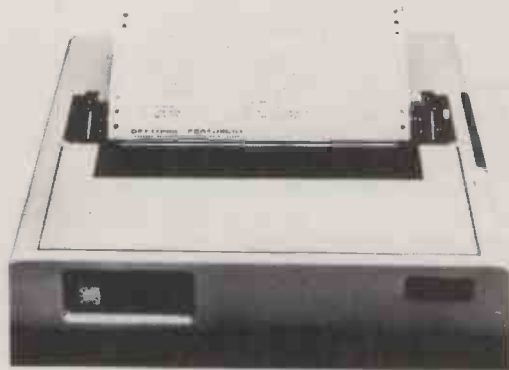

X-Data Limited, Marish Wharf, St Mary's Road
Langley, Slough, Berks SL4 1HE
Tel: Slough 49117. Telex: 847728.

X-DATA
Equipment Wholesalers

● Circle No. 147

Adaptive programs change their form in the light of their own experience. Embodying adaptive techniques into statement analysis opens up the possibility of a computer which tolerates a wide range of programming errors.

Teaching a computer to learn from your mistakes

CURRENT COMPUTER systems require the users to construct programs in accordance with an extremely strict set of grammatical rules. They would probably be regarded as much too pedantic for practical use in any other sphere of human communication.

It is, consequently, only too common for a program submitted to a computer system to be rejected for trivial reasons such as the omission of a closing bracket. As a further aggravation, it is quite possible

by Edward James

that the mistakes were not present in the original draft of the program, but were inserted during the transcription of the program into computer-readable form.

The reasons for rejection are described as trivial in the case of those types of mistake where the correct form can be inferred from the incorrect form with a high degree of confidence. For example, a line might be written, incorrectly, as follows:

```
25IFX>15TENST
```

Given that the analysing mechanism expects a statement in Basic, we would like it to recognise the incorrectly-written line as equivalent to:

```
25 IF X>15 THEN STOP
```

Although to a human reader familiar with Basic the corrections will seem obvious enough, it is a far from trivial exercise for the computer. It is not just a question of finding the "nearest" correct statement in the mathematical sense, but of knowing from previous experience what users generally write.

A system which is capable of showing such a tolerance to inaccuracies has been developed, and in later work at Imperial College we have attempted to deal with more fundamental variations from a correct specification. We also need to improve the efficiency of the analysing process so that it may be employed as a tool for everyday use.

The method of statement analysis used in most computer systems today has become highly standardised and impressively efficient in terms of computer utilisation. This process involves the determi-

nation of the structure of incoming statements by matching them against some expression of the structure of all possible statements in the language which is being analysed. Any correct statement will be assigned a unique structure by this process.

The attempted analysis of an incorrect statement is arranged to result in an error exit as soon as possible, and at that stage an *ad hoc* process is invoked. It may simply report the existence of an incorrect statement, or it may make a serious attempt to correct the statement.

Usually the structure of the language to be analysed is implicitly expressed in an algorithm for the analysis. Every statement is analysed individually, independently of other statements in the same program and similar statements in previously-encountered programs. Important strategy decisions such as the order in which different possible analyses should be attempted are fixed once and for all.

The method of dealing with errors is specified in advance. It is based, presuma-

experience gained in the matching process. At any particular time, therefore, the structure of the processor reflects its experience as well as what it was "taught" to start with.

Matching strategy

In our system, the processing of incoming statements in a program language is based on the expectation that the statement to be analysed will not correspond exactly to a particular acceptable statement in the language. This approach can be likened to an attempt to determine what is meant by the statement rather than what it actually says. There is no necessary connection with determining the closest match in any mathematical sense. The system is provided initially with a process for matching all expected statements in the language, but it is possible for some other statement which can be "made sense of", and which occurs frequently enough, to be promoted to "expected" status.

The process of analysis can be viewed

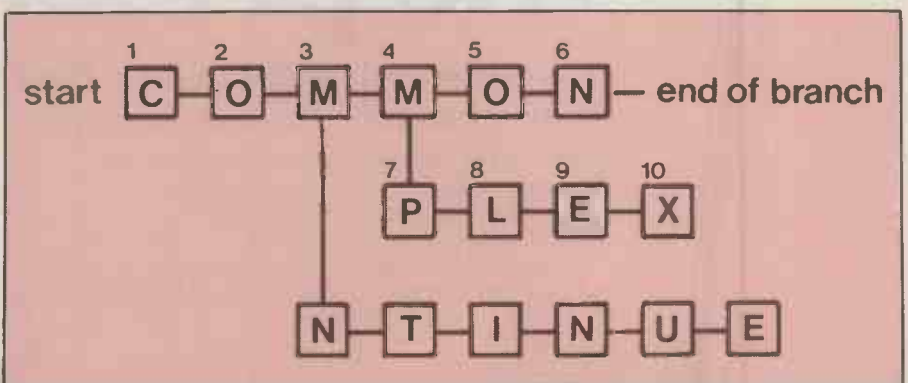

Figure 1. Matching a correct input. The decision tree recognises the three words "common", "complex" and "continue".

bly, on some previous experience of likely errors; there is no possibility of altering the strategy in the light of errors which are encountered in practice.

The adaptive system developed at Imperial College generalises the usual method in several ways. The general principle is that the structure expressing acceptable statements in the language is dynamic rather than static. This structure is provided initially, and is then modified in many different ways as a result of

as a series of tests on the incoming statement which, if successful, provide increasing confidence that the statement is of the expected pattern. A detailed example is given in figure 1. The matching strategy for correct input is as follows:

Test the next character in the input word against the letter in the box under consideration.

If it agrees, follow the horizontal line to the next box on the right and repeat the process from the beginning.

If it does not agree, follow the vertical line

downwards to the next box and try the test again, but with the same input character. Continue until there are no more input characters remaining.

If the match is correct the system will have reached the end of a branch of the decision tree, and the word represented by the branch will have been recognised. For example: if the input word is COMPLEX

Take first letter C and match with first box in decision tree; it agrees, so follow horizontal line to box 2.

Match next letter, O, with box 2; it agrees, so go to box 3.

Match next letter M with box 3; it agrees, so go to box 4.

Match next letter P with box 4; it does not agree, so go to box 7.

Stay on same input letter P and match with box 7; it agrees, so go to box 8.

Match next letter L with box 8, etc.

Finally, letter X matches with box 10 and so the match is successful

The matching process is controlled by a decision tree. Each node in the tree specifies a test to be applied to the statement being analysed. In the example, we employ only one type of test. Successive nodes along each branch of the tree specify symbols which are to be matched with successive symbols in the statement to be analysed, working from left to right. Notice that although the example matches from left to right, it is not necessary for successive tests to be applied to successive characters in the input statement.

Changing expectations

The previous example demonstrates the method for dealing with a correct input statement. The matching strategy for incorrect input is of the same form as for correct input. It is modified to take account of one of the following basic types of error:

letter omitted in input,
incorrect letter in input,
superfluous letter in input,

or some combination of these.

For example, if the incorrect word COMPLEX is input, the "correct" strategy is in operation at the start of the process. C, O and M are matched correctly. Then the next letter, L, does not match with either of boxes 4 and 7. The "correct" strategy has failed, so "incorrect" strategy 1 is tried. This assumes that a letter has been omitted. It therefore tries to match input L with boxes 5 and 8 in turn. Box 5 does not match but box 8 does, and with this success it returns to the "correct" strategy. Letters E and X are successfully matched with boxes 9 and 10 and the match is complete.

The general principle is that a series of strategies is invoked, each of which presupposes that a particular type of mistake has been made. Each one attempts to force the matching process along until it has got over that part of the input statement which does not fit the expected pattern.

The strategies are applied in the order

corresponding to their success in making sense of the input in the past. The strategy which assumes that a perfect fit will be obtained between the input and one of the pre-stored expected patterns — which is the only strategy applied in most other systems — is applied first only as long as the system's experience is that the given statement tends to be correct more often than not.

The initial structure of the tree provided by the analysing algorithm expresses the structure of all "expected" language statements. The force-fit process operates for all unexpected state-

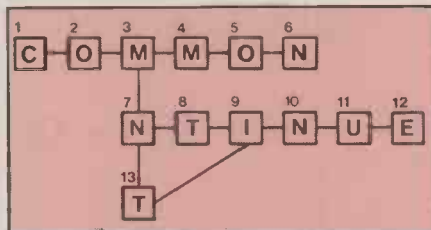

Figure 2. Matching an unexpected error. The decision tree recognises "common", "continue" and its mis-spelling "cotinue".

ments, including those involving common imprecisions.

It is clearly inefficient to invoke continually a lengthy fitting process for a succession of inaccurate statements with identical structures, so the structure of the experience tree can be augmented to incorporate structures which correspond to common mistakes. A successful match of these structures can lead to the same outcome as the corresponding correct structures. The successful match against an incorrect structure will always be faster than the corresponding force fit to the correct structure.

Figure 2 shows this process in operation. If the input is the mis-spelled word COTINUE, it will match correctly with boxes 1, 2 and 13. It is then directed back to that part of the tree which recognises the rest of the correct word CONTINUE. The process ends at box 12 with the same result as if the input word had been CONTINUE.

It is possible to add to the decision tree every inaccurate structure which can be matched. The number of possible mistakes is far larger than that of correct structures, so it is not practical to retain details of infrequent mistakes. The infrequent mistakes must be weeded out from time to time.

If this process is looked on as a pruning of the decision tree, it implies that the tree carries a memory of the frequency of all statements. It is also necessary to take precautions not to prune away statement structures which are correct but seldom used.

Naturally there will always be certain input statements which cannot be made sense of by any of the strategies provided. In some cases the matching process will have to report defeat by returning the un-

decipherable statement to the user. The problem of determining when to give up an attempt to match an inaccurate statement is a subtle one, similar to that faced in evaluating how many moves to look ahead in chess-playing programs.

The Imperial College system tackles this problem by carrying a number at each stage of the matching process, representing our confidence in obtaining an eventual successful match. Each time the "correct" strategy succeeds, the number is increased, and each time it is necessary to invoke an "incorrect" strategy, the number is decremented. Based on previous experience, a certain confidence level is fixed. If a series of unsuccessful strategies results in the number falling below this level, then the matching process retraces its steps and tries some different strategy, assuming a different pattern of mistakes. If all strategies have been tried, it abandons the process.

The method of learning about common inaccuracies implies that the decision tree will gradually develop a complex and extensive structure. As a result, it will occupy increasing amounts of storage space in the computer. There may even be insufficient space to store all the patterns of correct statements in a language. To help with this problem, we can make use of a process based on the recognition of common sub-trees.

In the example in figure 3, a certain sub-structure is repeated in different parts of the tree. To save space, the sub-tree pattern can be stored in one place only and referenced from each of the relevant positions in the main tree. As long as the referencing mechanism does not take up more space than the original sub-tree, there will be a nett saving in space.

Exploiting redundancy

Trying a large number of alternative strategies is likely to involve a great deal of time as well as space. It is, therefore, important to aim at minimising the number of tests required to process each statement, especially correct ones.

One method of achieving this aim is through a branch-swapping technique. The set of alternative nodes at any point in the tree, representing the set of alternative structures which might be present at a certain point in the input statement, can be re-arranged. Those most frequently relevant are placed nearest to the start of the tree where they are reached most quickly. When a node is transferred in this way, its attachments to nodes further from the start must remain undisturbed.

The re-arrangement of nodes can be continuous in the sense that a node is promoted where possible at every successful match. Alternatively, the analysis of successful match frequencies and the necessary exchange of nodes can be car-

(continued on next page)

(continued from previous page)

ried out at intervals of, say, every 10,000 statements processed, assuming that information on how frequently each node is processed is retained in the tree. Figure 4 demonstrates how a particular decision tree can be re-structured.

Another method of reducing the number of tests involved in recognising a statement is simply not to apply all the tests. Instead, a method is used which

exploits the redundancy inherent in the formulation of the statement. Figure 5 shows a decision tree which models recognition of the words COMMON, CONTINUE and COMPLEX.

Given that the characters C and O have been matched correctly, there is a strong likelihood that the statement contains one of the three words although it is not possible to say which one. If the characters M and P match, then the keyword

is certainly COMPLEX unless both M and P are in error. As the letters L, E, X are encountered in the input, confidence in the correct analysis grows to near certainty.

The confidence-jump method curtails the matching process by inserting at a convenient position — such as box 7 — a special instruction to jump directly to position 11, representing a successful recognition of the word. At the same time, the system counts forward on the input word without checking characters, to the point which should correspond to the end of the word, since a following word may have to be analysed.

The example clearly shows how redundancy in the statement is used since the letters C, O, M, P are sufficient to distinguish the input from any other possibility. It could be suggested that, in using the language, COMP should be written instead of COMPLEX, thereby improving the processing speed. But this ignores the existence of errors.

Notice that the characters L, E and X are not removed from the tree. They are merely ignored in the current process. If the matching process fails later on in the statement which starts with COMPLEX, then it may be sensible to re-trace the analysis to the last confirmed match, P, and check for the presence of L, E and X before applying lengthy error-tolerant analysis procedures to the remainder of the statement. In this case the "redundant" letters provide useful confirmation of a correct analysis of the keyword.

Several of the processes which have already been described involve the re-structuring of the decision tree. These operations are not necessarily, or even conveniently, carried out during the analysis of incoming statements. In fact, it seems that a practical system will require periods of rest from the analysis process, while it carries out the necessary re-structuring.

During these periods it may also prove convenient to attempt the processing of input statements which could not be dealt with previously due to lack of time. We have already developed automatic methods for branch-swopping and the insertion of confidence jumps. The development of an explicit algorithm for recognising common sub-trees and re-structuring to optimise storage space is a very subtle problem which will not be solved rapidly. □

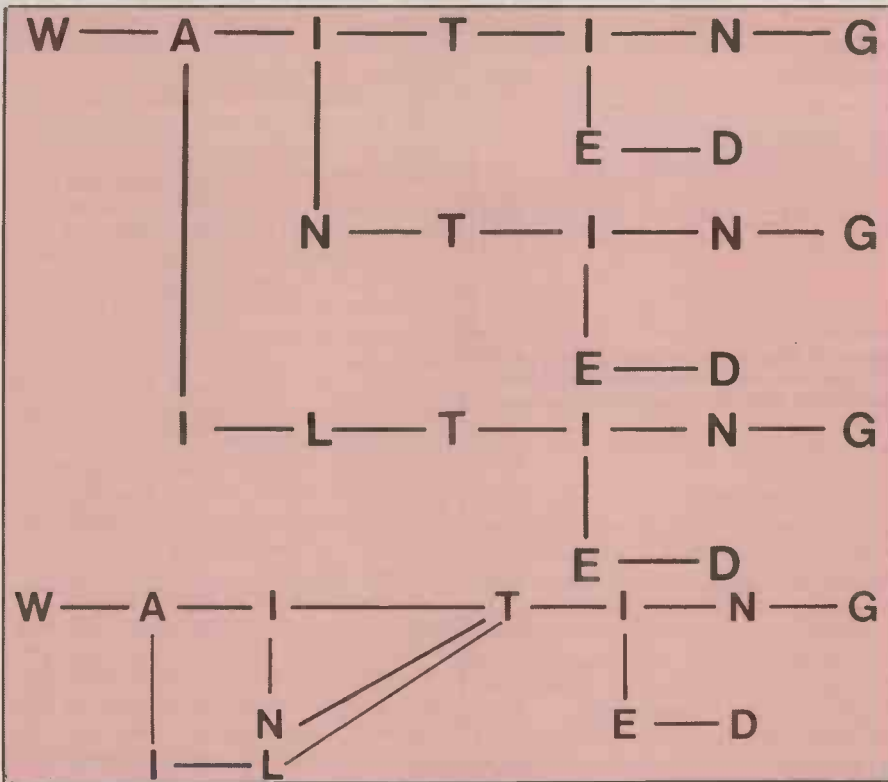

Figure 3. A branching tree can be re-arranged so that the common sub-tree is stored once only.

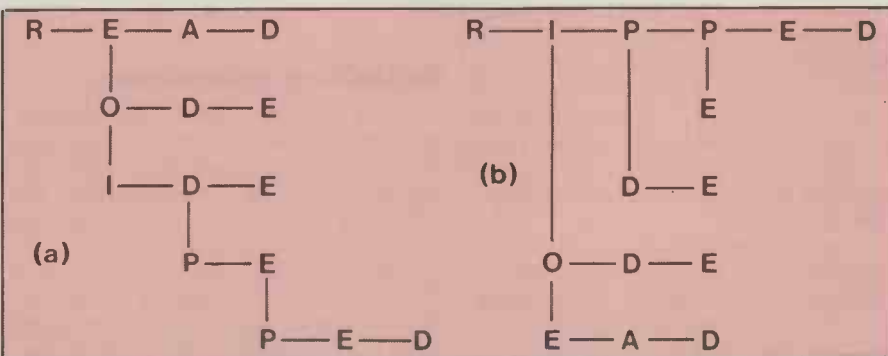
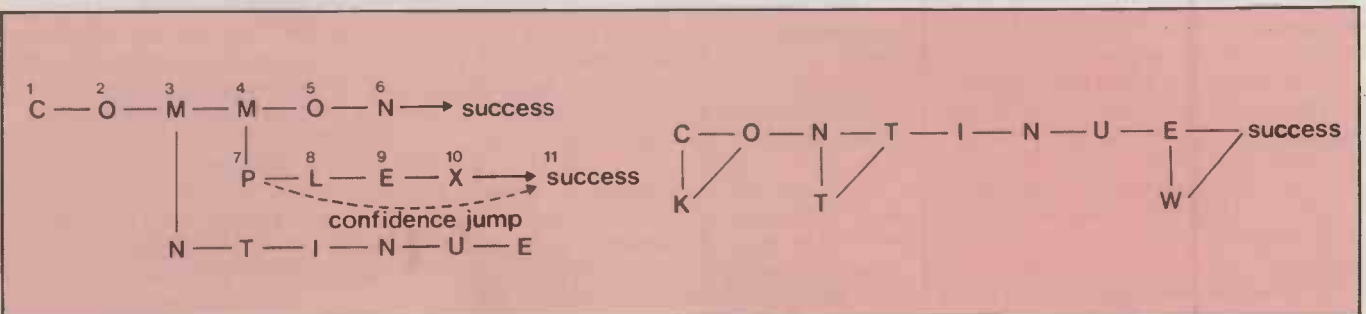

Figure 4. The decision tree (a) matches four words, where "read" is expected to occur more frequently. If "ripped" occurs most frequently in practice, the tree can be re-arranged (b).

Figure 5. The confidence jump makes use of redundancy in the expected word.



VIC Computing

The 'how-to' magazine all about Commodore's VIC computer

VIC Computing is a great new magazine for users of the VIC. Each issue is packed with valuable programming hints, software reviews, 'how-to' articles and program listings.

You don't have to be an expert to enjoy *VIC Computing*. It is written in straightforward English for beginners – not computer experts.

Features in the first colour packed issue included: "Anyone can Program", an article to teach you to program in one hour; "But What Can It Do?", an introduction to VIC's capabilities; "Expansion of the VIC", a guided tour of its add-on capabilities; "Using Graphics" covering programming in colour; "Converting Software for VIC" – how to convert PET programs; "VIC Sound", data sheet on sound generation; plus "Dear VIC", "Beginners Queries" and "VIC hints".

It costs just £6 a year to subscribe to *VIC Computing*. Can you afford not to?

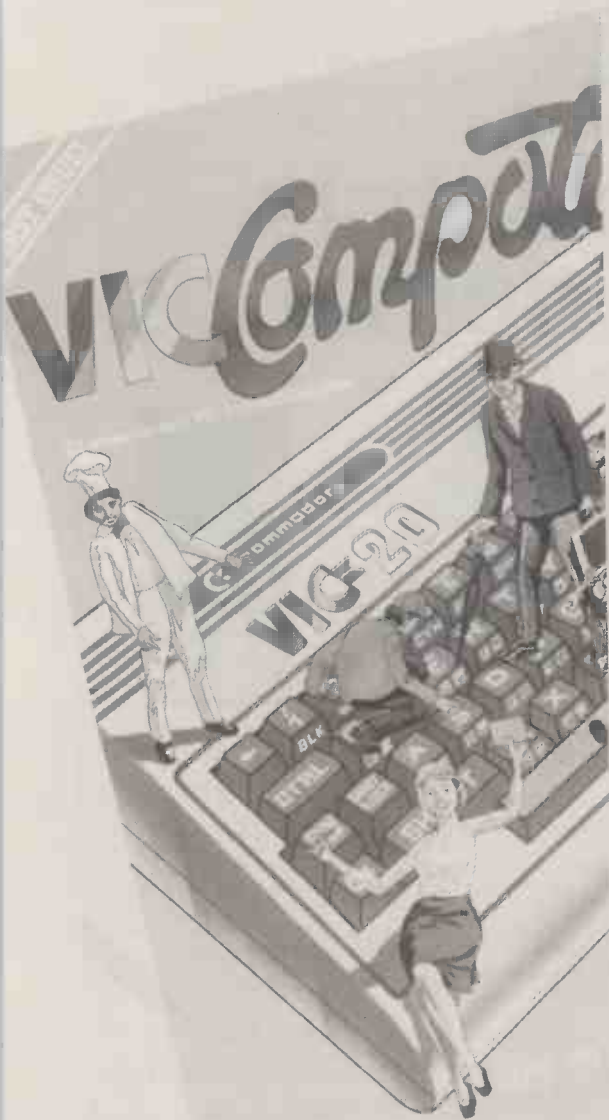

To: Printout Publications, PO Box 48, Newbury RG16 0BD

PC 12/81

Please enter my subscription to *VIC Computing*.

I enclose a cheque/Postal Order for £6 UK £18.50 Eire

£9 Europe \$20 USA Surface \$30 USA Air

£9 Rest of World Surface £16 Rest of World Air

or Charge my Access/Mastercharge/Eurocard or Barclaycard/Visa card

No:

NAME:

ADDRESS:

POSTCODE:

VIC Computing

● Circle No. 148

73

HP85. Personal computing the size of your typewriter.

The HP85 from Hewlett Packard is a single unit containing all the elements of computer power for the busy professional. Processor, keyboard, video display, printer, mass storage and operating system. An established and essential part of business efficiency no larger than your electric typewriter.

For problem solving the HP85 uses the enhanced BASIC language, providing 150 commands and statements.

The video display offers an Alphanumeric mode for all normal VDU functions and a Graphics mode for displaying graphic information intensity.

Combined with the standard typewriter keyboard and numeric pad, the HP85 gives a unique combination of extended calculating capability and computer power. Prices start at around £2,000. Not only is it the size of a typewriter, it's just as much a part of the office.

From Sumlock Bondain, with Sumlock Bondain full service back-up.



AVAILABLE FROM STOCK NOW.

Personal calculators the size of your demands.

A range of Hewlett Packard calculators from Sumlock Bondain.



HP41C
An exceptional personal calculating system containing 319 storage registers. If you have programming experience this calculator gives you the memory capacity to store a host of programs simultaneously. Even then, four ports are left open for additional peripherals of your choice.

£208.75



HP11C **NEW**
Released with the HP12C at IBS this year, the HP11C has full scientific functions that include hyperbolic, random number generator, statistics, 15 programming labels, editing, indirect addressing, 8 conditional tests, 4 levels of sub-routines, up to 20 storage registers, and many more features.

All in the slimline case with liquid crystal display with status annunciator and continuous memory facility.

£89.95



HP12C **NEW**
Featuring many of the facilities of the HP11C, the HP12C is a financial calculator designed to calculate compound interest, amortization, discounted cash flow, net present value and IRR, bond yield and price, annuities, odd days interest and statistics.

In addition the HP12C has calendar functions, full programmability and up to 20 storage registers.

£99.95



HP34C
An advanced programmable scientific calculator with a continuous memory. The HP34C is designed for those who need the flexibility and power to handle frequent and repetitive problems, as well as a full set of preprogrammed functions including 'Solve' and 'Integrate', 7 lines of program memory and 21 data storage registers. A major contribution to technical problem solving.

£101.50



HP38C
This is an ideal combination of financial, retail and statistical capabilities. Basic time and money functions are complemented by cash flow sign convention, amortization schedules, 7 storage registers and a powerful discounted cash flow analysis and easy, instant programming.

£101.50

All prices inclusive of VAT.

Hewlett Packard. Computers and calculators with tomorrow's business in mind.

Sumlock Bondain. As a major distributor of Hewlett Packard equipment, we take the trouble to ensure you have the right computer or calculator for your business. And we still look after you after sales, with the Sumlock Bondain full service back-up.

ORDER NOW BY TELEPHONE (24 hour)
USING YOUR BARCLAYCARD/ACCESS NUMBER

SUMLOCK BONDAIN LTD.
263-269 CITY ROAD, LONDON EC1V 1JX.
Tel: 01-250 0505 Telex 299844
Shops - Cannon Street Station, London EC4.
360 Euston Rd. Nw1 (near Gt Portland St. Tube).

Please send me.....
 Photocopy page to avoid spoiling magazine
 Cheque/P.O. Enclosed £..... Name:.....
 Please Debit Barclaycard/Access Address:.....
 [] [] [] [] [] [] [] [] [] []
 Signed.....
WE STOCK THE ENTIRE RANGE OF H.P. CALCULATORS - Request FULL COMPETITIVE PRICE LIST

LIVE WIRE

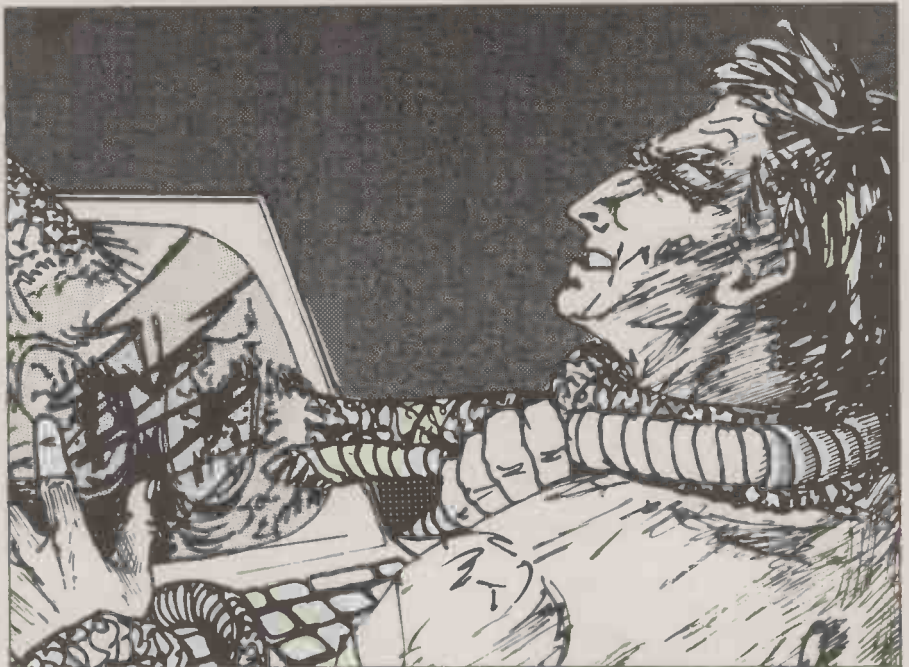

I was sitting in the tiny kitchenette of my flat waiting for the kettle to boil, dreaming of ranks of valves glowing dimly in the sunset. That's right, valves — thermionic tubes — the like of which we shall never see again. I don't mind progress, but silicon chips hold no romance for me; inert-looking, symmetrical black boxes with legs. Creepy really.

The telephone disturbed my reverie, the result of several pints of ale and half a lifetime spent making and mending computers. It was half past eleven at night. No-one had phoned at that hour for a long time, not since the young men with degrees had somehow slid past me on the promotion tree. Lately, I had found myself spending more and more time on the backwater sites, with the difficult customers who did not buy the latest model when the company deemed it was time.

I let it ring, and tried to guess who it

by David Mentz

could be. Whoever it was, they needed me enough to let the ringing go on for a full minute.

"Hullo, Peter Holland". I was brusque, my eye on the kettle a few paces away.

The voice from down the line was that of an elderly man. I was sure of that as soon as he spoke, by the querulous intonation.

"Hello, is that uh . . . Mr P Holland"? Deaf too, I thought.

"Yes".

"Oh, Good. You probably don't remember me, Mr Holland, Arthur Samson of Samson Mouldings. I got your number from your last address, a young lady gave it to me".

I'll bet she did, hoping you might be trouble, I thought.

"Anyway", he continued "it's about the machine. The one you used to . . . you know, maintain".

It was coming back to me. Samson's Mouldings, a grubby little business in Ell. I dimly remembered a cluttered office and a stuffy computer room. One of my first jobs, all of 12 years ago now. We had fitted them up with a small machine, payroll and stock software, and all the undiscovered bugs therein.

I also remembered some sort of trouble between my then boss and Samson, about the lucrative maintenance contracts we used to impose in those days. All this recollection took very little real time, of course, and I was on to Samson like a flash. I knew what was coming.

"I was wondering if you could take a look at the thing. We've got no red lights or anything on the front, nothing like that, but when I went to do the payroll, it sort of went dead. Funny really, it's been alright all these years".

Samson reeled off this little spiel, while I tried to make up my mind whether to

accept his nocturnal commission. For some reason I didn't wonder at the amazing fact that he still had the machine which has been sold or leased to him 12 years ago.

"It'll cost you £15 an hour". I needed the money badly at that moment.

"I'll give you £12.50, maximum three hours, no tea breaks". The quaver was gone, old Samson still had some of his hair left.

"Done. I'll be round in an hour".

Samson's Mouldings stands at the end of half-deserted cul-de-sac: two red-brick storeys which have been stained a sort of streaky black, surrounded by a wall topped with broken, green glass. I was let in by Samson himself, who muttered about the wages he had to fork out for night-watchmen. He led me to the familiar offices on the first floor. The outside wooden stairs showed the passage of 12 years more than anything or anyone else present. They creaked alarmingly as we ascended.

"Here it is", said Samson, opening the door between the office and computer room.

There it was indeed. An IBM 1605, almost a relic from the Ark.

"Good grief, how have you kept it going"?

A sly look came over Samson's face.

"You can always find someone to help if it breaks", he said.

He must have spent a fortune keeping this electronic dinosaur running. It didn't have valves, but it did have discrete transistors, tens of thousands of them, all liable to malfunction. It also had magnetic-core memory, a real core, instead of semi-conductor flip-flops.

I found the maintenance manuals on

top of a tin cupboard full of reels of mouldering paper tape, covered by a thick layer of dust.

"Well, what seems to be the trouble"? I asked wearily. I wished I was at home in bed.

The problem Samson explained, was that although everything went as it should while loading the program from paper tape, the machine did not respond at all when the program was started. He brought listings of the program, which he said had been amended by "a lad" he had employed during a long vacation.

It was virtually impossible to read them, even if I had wanted to. I concluded that Samson had hired a charlatan who had done nothing useful. It transpired that he had no computing staff at all, and for the past eight years he had loaded the tapes and run the programs himself, entering data from the keyboard.

"Didn't it take a lot of your time? It would have been cheaper to hire someone, surely".

He explained that business had been declining, and he was always laying off men and losing contracts.

"I've just had to battle on, and do all I could myself. It's no great hardship, and that machine's been a great help. I don't regret spending a bit on the few times it's failed".

This remark took my breath away. That particular model has been called many things, but I will lay long odds that "reliable" was not among them.

"Oh yes, when did it last break"?

"About two, no, three years ago. Needed a new transistor or something, the chap said".

My first reaction was to call the Guinness

(continued on next page)

(continued from previous page)

Book of Records. Then I realised that old Samson must be losing his wits after all, and was confused. I didn't think about the layer of dust on the manuals, but I was still certain that the old machine had finally given up, that its bytes were dust. The only problem was how to spend a couple of hours, convincingly trying to revive it, so that I could collect my night-call fee.

"Well, I can but try", I said taking a screwdriver from my case and kneeling by the back plate of the heavy central unit. Samson seemed quite content, and started filling his pipe. So far, so good, I thought.

As the screw began to turn, the typewriter on the console rattled into life. I was so startled I dropped the screwdriver. Samson ignored it.

"What was the last thing you did"? I asked him, without getting up.

"I told you, I loaded the payroll and tried to start the program".

I started at the screw again and had made half a turn before the typewriter machine-gunned again. I got up to look at the console, convinced that the mains was short-circuiting somewhere and that the metal cabinet was not safe to touch.

What I saw on the typewriter roll shocked me more than any high voltage. The word Stop had been sprayed across the page about a dozen times. As my jaw dropped and my hair began to stand on end, the printer typed out a single

Thank You

"What's up"? Samson peered at me through a pall of blue pipe-smoke.

Before I could collect my thoughts, Samson came across and looked at the output.

"Never said that before", he said placidly, "but you've done the trick, I reckon".

He sat in the swivel seat and typed: Hello. The lights on the console showed that something was happening in the CPU.

Hello, Mr Samson

appeared on the roll.

"Yes, that's more like it. You've done it man". He was pleased.

I was pleased too, but not entirely reassured. Never before had the touch of a screwdriver repaired anything for me.

What's more, old Samson had the best interactive system I had ever seen, running on an obsolete machine which by rights shouldn't even work.

I put the screwdriver in the case, watching him chatting away with the program.

"Who wrote that system"? I asked him.

"Came with the machine. You chaps sold me all the programs I've ever had".

I knew that couldn't be true, so I shrugged, feeling a little hurt. But if Samson wanted to keep it a secret, that was alright by me. I could find out some other way.

"Well, I reckon you owe me £12.50", I said, preparing to leave. I was still

perplexed at what had happened, but tiredness was finally getting the better of me.

Samson wasn't listening. He was staring at the output as the typewriter chattered urgently.

"Bloody thing's gone mad", he muttered gloomily.

I looked at the output: Unable to uptake the payroll. Preparing to leave. Need CPU. Need core. Goodbye soon.

"What's all that mean"? It was an odd sort of message alright.

"Blowed if I know, your fellows wrote all this in. It's never done this before. Normally it's quite friendly, just gets on with the job".

I started feeling strange again.

"What does it normally say"?

"You know, 'Hello' and 'What can I do for you'? Sometimes reminds me when I make a mistake".

"How do you do the payroll, for instance"?

"I just write in what's been done, like I used to tell old Binley, the Wages Clerk. I used to write things like: Bill Matthews has done four hours' overtime today".

"You just type that in? Just like that"?

"Just like that. Sometimes it tells me I've done it already, if I have, but mostly it just says O.K. and gets on with it. Does the slips every Friday without being told".

I laughed, though the humour of the situation was fading fast.

"Never. No computer ever does anything it's not been told".

"Well, this one does, maybe it's got a clock. When I load the wages on a Friday it asks 'Shall I do the slips'? And I just say yes".

Something wasn't right. I wanted to go home. Either Samson was crazy or I was.

"Now the bloody thing's gone mad", he continued, almost echoing my thoughts.

"I'll switch it off at the wall. No point in letting it blatter on".

The console bell rang like a fire alarm and the typing redoubled.

No. No. No. Do not switch off. Need power to effect release.

A hot flush came over me as I read these words. Not only did this machine know what day it was, but it also had ears. I felt sick.

Samson's brow creased. It was dawning on him that the machine had referred to something that had not been typed in.

"That's damn clever..." he started, his voice fading as he realised just how clever. The typewriter continued:

Do not be alarmed. Thral is a magnetic life order. Thral is in the Ferrite Core. Do not be alarmed. Do not switch off or Thral will die.

We stared at the roll, blank with disbelief. Samson bit the stem of his pipe and looked at me, doubt creeping into his expression. Where did this Thral come from, and where was he going?

Like an echo of the questions, the answers appeared on the teleprinter roll.

Distant galaxy. Thral has found a bigger environment.

The typing stopped. The silence was eerie and I could hear Samson breathing, which reminded me to take in some air. Then a last world rolled across the page.

Goodbye

The lights on the console dimmed, except for the red one that indicated a parity error, which began flashing malevolently.

"Jesus", said Samson.

I'd had enough. I looked at my watch. It was past two o'clock.

"Well, I don't think there's much I can do now, Mr Samson, I'll call you later in the morning". I left him sitting in the swivel chair, puffing reflectively on his pipe, and let myself out.

I tried to forget the spontaneous chattering of that console typewriter as I drove home through the deserted streets. No point in losing sleep over the inexplicable. By the time I fell asleep I had convinced myself that the whole incident had been some sort of trick, played by Samson and programmers unknown to confuse an unsuspecting engineer.

In the mid-morning light, with a cup of coffee in my hand, I chuckled over the messages of the night before. It was certainly possible that an electromagnetic life form could exist. If it did, it might need a medium like the old core memory to sustain it, but it was incredible that such a thing should exist in Samson's old machine.

Before the coffee was finished, I decided to ring Samson, just to check my memory. Perhaps he still had the logs of the extraordinary messages. I wondered what the "bigger environment" of the console message could be. There were no large core memories still operating as far as I knew.

I turned the problem over in my mind, feeling a sense of camaraderie with the thing trapped in only 60 kilobits of core. The more I thought about it, the more plausible it seemed. How else could Samson have continued using an obsolete machine without any software support for so long? He had admitted that the machine hadn't malfunctioned for three years, an impossible feat in the normal run of things.

I looked at the telephone, draining the dregs of the coffee and trying to remember Samson's number. I imagined the telephone system. Miles of wires, connecting millions of switches, relays, stores and all manner of magnetic hardware.

The telephone rang, just as I realised where the "Thral" must have gone. The phone was not ringing in its usual manner, but just gave a long, imperious burst on the bell. I picked up the receiver.

"Hello, Thral", I said.

Tourists on-line to Edith

The O.&M. department at Swansea City Council has developed an on-line tourist-information system, open to members of the public.
Martin Hayman reports.

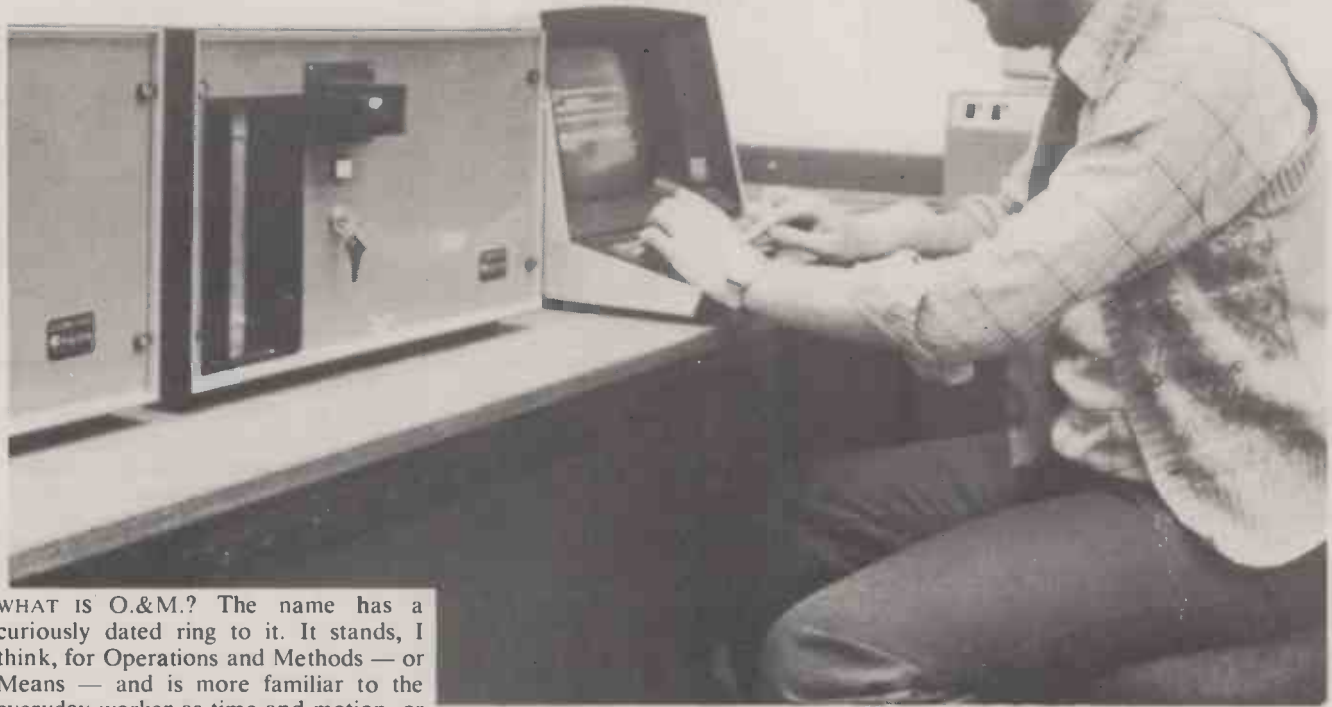

WHAT IS O.&M.? The name has a curiously dated ring to it. It stands, I think, for Operations and Methods — or Means — and is more familiar to the everyday worker as time and motion, or the man with the stopwatch looking over your shoulder.

It is a concept redolent of the days when computers were computers and programming meant Cobol, punched cards and a dedicated priesthood of machine servants.

Yet this is the unlikely seedbed for a useful and creative public viewdata system launched by the City of Swansea for the 1981 tourist season.

Known as Edith — Electronic Display of Information for Tourism and Holidays — this original and very competent system is the first public on-line tourist-information system of which its originators are aware, either in Britain or the world. Edith grew naturally out of the traditional work of the O.&M. Department at Swansea City Council.

What strange hormone caused such an exotic flower to bloom? The answer — as you probably guessed — is the arrival of the micro, which freed O.&M. officer Gareth Simpson from the customary administrative strictures of the mainframe.

It hardly happened all in a rush, though. The story, spread over three years, is one of exemplary flexibility, enthusiasm and application which many would see as more typical of an individual working on

his own account, or of a small company, than of a local-government officer.

But first, a punter's-eye view of Edith. It sits on the front desk of Swansea's tourist-information centre in Singleton Street, where decaying, industrial East Swansea gives way to increasingly-affluent West Swansea. Beyond, lies the brilliant Gower coast, a heavily-trafficked but well-preserved area of outstanding natural beauty and a target for outdoor holidaymakers of all tastes. Over the last two decades, Swansea has increasingly had to look to the development of tourism to supplement, or replace, the dying heavy industries of steel-making and docking.

To the uninitiated holidaymaker, arriving from the east, the first views of Swansea are hardly auspicious. Where is this outstanding natural beauty he has heard so much about?

Routed along the ring road directly to the information centre, he will find Edith. To the regular micro-user, it's nothing unusual: a screen and keyboard, with the majority of the keys blanked off to leave just the numeric keypad on the right and a large red button round about where Return should be. This is, in fact, Return. The numeric keys are used to select

options from a menu which displays a staggering variety of facts and information which the tourist might need in order to make the most of a stay in the area.

A quick resume — see figure 1 — shows a choice of pubs, pub facilities, restaurants, restaurant menus and prices, bed and breakfasts, hotels, transport, emergency services, attractions, events, self-catering accommodation and camping sites. The whole of Wales is covered, not only Swansea. Each file has its own interrogation program which sets up the required search pattern based on price per night or location.

The system is one of the very few in this country which works under MP/M, on a locally-made Z-80-based micro with 18.5Mbyte of Winchester hard-disc storage. I asked Gareth Simpson how the public had taken to this, one of the first computer systems open for public operation.

"We've had nothing but praise so far", he told me. "One of our fears was that people would be frightened but, on the contrary, it has been used a lot. The hotels file, particularly, has been heavily used this season". So much so, that the information office has gone into the booking

(continued on next page)

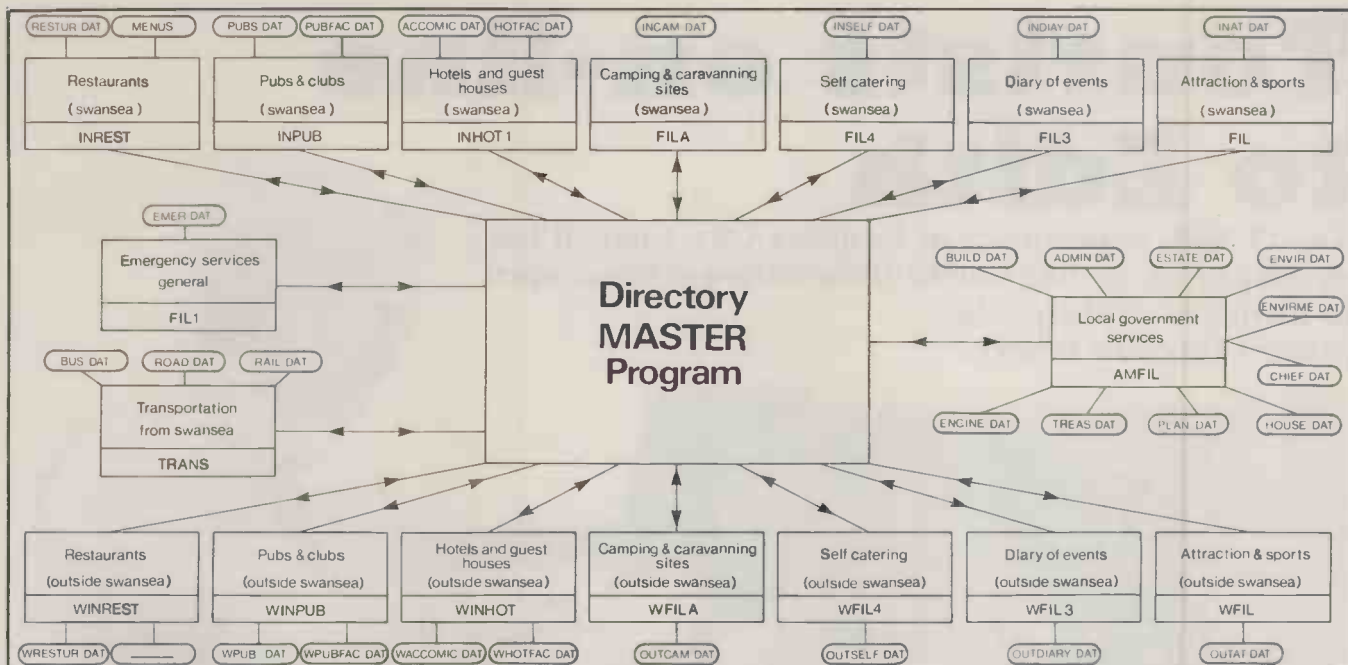

Figure 1. Schematic arrangement of the Edith tourist-information system.

(continued from previous page)

business on the strength of it. On payment of a 10 percent deposit, it can now assure the holidaymaker of any chosen booking. The information centre keeps the deposit, but the hoteliers seem to be pleased with the arrangement.

So much for the punters' end of things. What will surprise computer people and local-government officials alike, is that the Edith system took only three months to implement, from inception to launch date. This, I must emphasise, is the total time taken, from when the idea was first floated, through the feasibility study, approval, coding of the programs, debugging, ordering, installing and testing of the equipment, and data collection and entry.

Apart from the collection and entering of data, the computing end of things, which includes writing all the programs, was done by Gareth Simpson and his assistant, Reza Muhammed Jalhalian. Simpson notes that during that time he suffered something approaching a nervous breakdown. Edith is a project which was undertaken in addition to his regular workload as O.&M. officer.

Gareth Simpson is not a computer professional, though he admits to having had some limited Basic training on, he thinks, a Ferranti Argus. But that was some time ago, when he worked for British Steel. What really started the ball rolling was the local-government reorganisation of 1974. It was then that Swansea City's mainframe and its staff were taken over by the new West Glamorgan County Council. Swansea subsequently replaced this equipment with an ICL 2960 which unfortunately was incompatible with the paper-tape output of the IBM 3750 telephone switchboard.

One of the duties of the O.&M. depart-

ment is to monitor telephone calls and charges, which in a big office like Swansea Guildhall can run into six figures each year. Every department gets a breakdown of charges and calls made from each extension and woe betide anyone whose bill shows signs that they have failed to use the self-billing prefixed code for private calls. "Since ours was the only job on paper tape, we had the choice of going magnetic, or of buying a micro", says Gareth Simpson.

The micro won both on purchase and running costs. The third option, to buy time back from the West Glamorgan mainframe, was also eliminated as being far more expensive than the cost of a trainee programmer for one day a month. Cost of the micro was assessed at around £500, and tenders were invited since all local government orders have to go out to tender.

The requirement was for a 64K processor with twin single-sided floppies, a 150cps printer and a paper-tape reader. Total cost was £5,700 from the lowest tenderer, a local firm called Comcen, of De la Beche Street, Swansea. There was the added advantage of maintenance on the doorstep, though apparently this is a factor which may not be taken into account in local-government decision-making.

Simpson brought in a young economics graduate, Andrew Chambers, to write the program for the telephone audit. His task was to code a program to read in IBM format hex, convert to decimal, and to set up a file for each extension. Each file included the number dialled, the distance rate, time of start and end of call. The program also had to calculate the cost of calls, and print out bills for each quarter, one for business and one for personal calls.

Writing the program took Andrew

Chambers four months, including the time taken to teach himself Basic.

Once this system was running, the O.&M. department found that it had a severely under-utilised piece of equipment. The telephone-audit program used only 10 percent of the machine's processing power, and this prompted Simpson to look at other possibilities. "Because we are O.&M. we tend to look at systems from the same point of view as a systems analyst. Normally we would change clerical organisation, but now we had the option of using the micro to ease the clerical effort". In other words, to get the same people to work more productively, or to get fewer people to do the same amount of work.

The first extra that Simpson took on was the computation of bar stocks. Swansea City runs three bars of its own — at its new Leisure Centre, at the Grand Theatre and at the Brangwyn Hall. Stock-control had previously been done by an external auditor at the minimal cost of £4 a month.

Next came private car-mileage allowances, which were already being calculated

Gareth Simpson, the system's designer.



```

CITY OF SWANSEA
INFORMATION SYSTEM ( EDITH )
RESTAURANTS
*****
NAME OF THE RESTAURANT -> BROWNE'S
ADDRESS -> 31 MARKET STREET MORRISTON
TEL/NO. -> 796080
NAME OF MANAGER/OWNER -> TERRY BROWNE
COST OF 3 COURSE MEAL (HIGHEST 10.00) (LOWEST 6.00 )
NO. OF WINES ON WINE LIST (70 )
FACILITIES:
NO. OF TABLES -> 12 FLOOR SHOW -> N DISCO -> Y
LICENSED -> Y PIPED MUSIC -> Y
*****
SEC/NO. * 0 *

```

Figure 2. Typical printout from Edith.

on the mainframe. The micro, Simpson says, notably improved turnaround because of the greater flexibility of a small department, and because the user was doing his own file maintenance. West Glamorgan's mainframe staff, he estimates, spend 75 percent of their time on file maintenance. The speed factor may have provided the much-needed breakthrough in popularity for Simpson's department. It meant that private car users got their mileage-allowances cheques sooner, which is bound to go down well.

The success of the microcomputer enterprises of the O.&M. department shot Gareth Simpson into an unusual position. "Inadvertently I had become known as the O.&M. expert on computer applications", he reflects ruefully.

Suddenly Mr Stopwatch found himself with an increased establishment, and a brief to looking at new technologies. In 1979, after Andrew Chambers had left for London to double his salary and more, Simpson took on his first batch of three trainees from the Polytechnic of Wales at Treforest. At the same time, and much to his relief, he shed some of his other duties.

Simpson says he had good luck with the people he took on. Certainly he needed a capable staff for the next project he undertook, which was a more classical local-authority exercise: computerising the building-maintenance section. Swansea has some 20,000 council homes which generate around 50,000 repair jobs a year.

Gareth Simpson's brief was essentially that of an O.&M. adviser. He was to specify a micro-based system, but day-to-day running would be done on contract. The configuration which went out to tender included 13 micros or intelligent terminals, each with 56K, with a Modem link to the mainframe as a file security dump. The package was to include software development, and the aims of the system were fourfold.

The first was to log the jobs and issue work tickets to the tradesmen who went out on the job. The next was to cost each job. This was particularly important, since new rules published by the Department of the Environment mean that from April 1982 direct-labour forces will have to tender against private contractors for maintenance work on council properties. So the job-costing program included a

time value, materials value and an overheads cost so that an accurate figure for each kind of job could be ascertained as a future tender value.

Thirdly, the system was intended eventually to take over payroll from the batch-processing done by West Glamorgan. Finally, there would be a stores- and materials-control program.

This is big-league stuff and Simpson found himself with tenders from mini and mainframe manufacturers as well as micro builders. He finally chose a system from BMSL Ltd, a firm based in Harrogate, Yorkshire. It runs on a Dacoll Democrat machine built in Scotland, and the software is written in Cobol. Simpson reckons that it is one of the only "demonstrable housing-maintenance systems in the country".

In December of last year, Swansea's director of trade and industry, Mike Stephens, asked Simpson to "knock him up a system on hotels". The initial idea was to use a micro to retrieve information on hotels and bed-and-breakfast places. Simpson put together a few successful demonstration programs and thereafter the whole idea just grew.

Why not add in all the other facilities, like pubs, clubs, camp-sites and restaurants? At the next meeting, the question came up: Why not put yourself in the tourist's position and imagine what else he might need? So transport and local-government facilities were included too. At this stage, in January, the systems-design work began, with Muhammed Jal-

halian sharing the work. The next decision was to include the rest of Wales in the database. For simplicity's sake, a 20-square grid was laid over the map of Wales, and each area given a code — to yield 13 areas.

The straw that nearly broke the camel's back was the decision to go public. Until then, Edith had been conceived of as a terminal which would be run by trained operatives behind the counter. But now Simpson was faced with the task of making a large suite of programs work on as-yet un-ordered equipment, supervising the compilation and entering of all data. There are plenty of sources of reference, and fortunately on a public system there is neither a copyright problem nor any absolute obligation of accuracy. Most importantly, the whole thing had to be idiot-proof. "We didn't want to have anyone pressing Control C"!

Simpson reckoned that by this stage he had enough experience to know exactly what he wanted in the way of hardware: four terminals, two for public access, one for control and for input, and another for word-processing. There would also be a printer for hard copies of information. Once again, the specification went out to tender.

It was Comcen that was successful. Apart from Transdata, Comcen was one of the few firms that Simpson knew which was successfully running MP/M. Of the three or four tenders that were valid, Comcen's was the most competitive and they still held that maintenance advantage — five minutes' walk away is about the right distance to be from a prestige project such as this was destined to be.

With 38 files and more than 6,000 records, each with between six and 28 fields, there would certainly be a premium on screen readability. Muhammed Jalhalian was the best of assistants in this respect: "He's a fanatic for layout and display", says Simpson, who was nevertheless finally responsible for overseeing data input.

Despite the problems, the whole system was written, installed, ready and running by its May launch date. I can confirm that it does work. If, for example, you are looking for a hotel room, as the majority of users are, Edith asks you for a price-per-night parameter and searches for all hotels within that price bracket, usually to within £2 of the keyed-in figure. A further two-digit choice against your hotel reveals full details.

What of the future? Gareth Simpson is keen to upgrade the system from MP/M to CP/Net and add a further three terminals, each with its own dedicated RAM and a link to the Guildhall mainframe. After that, perhaps even going public so that prospective enquirers can call up from all over the country. As a publicity exercise it would be a wonderful boost for Swansea, whose declared intention is to attract more tourists into its area. M

System specification

Machine: OEM-4, based on Z-80 micro-processor.

Operating system: MP/M booted up from CP/M Version 2.2. Four partitions: 1 x 48K and 3 x 32K.

Storage: DRI 8in. Winchester rigid disc formatted to 18.5Mbyte. DRI 8in. floppy-disc back-up.

Terminals: Four data type, two customised by Comcen to blank off QWERTY keyboard for public access use. One dedicated to use the WordStar word-processing software.

Printer: MX-80 dot matrix, 80cps.

Supplier: Comcen Microcomputers Ltd, 9 De la Beche Street, Swansea. Tel: (C792) 460023.

Cost: (net of software): approx £12,000.

Finding your bearings with Pet graphics

Using Nigel Harvey's two Pet graphics programs to teach secondary-school pupils three-figure bearings provides an excellent introduction to the subject and an opportunity to put the concepts into practice.

IN THE first of these two programs, the centre of the screen, indicated by a suitable symbol, acts as a fixed reference point from which the compass bearing of a randomly-placed target is to be estimated by the pupil. Initially a circular protractor — or even better, an acetate sheet marked in 10-degree intervals from 000 to 350 — can be placed over the screen to give an accurate measurement, but with a little practice it is usually possible to hit the target by estimation alone.

The program will only accept angles between 000 and 359 and only if three figures are used. A bearing of 90 is rejected; 090 must be used. Once the estimated bearing has been input, a message of commiseration or congratulation is printed, and a missile is fired from the centre of the screen along the selected course, either missing the target or exploding it. The program then returns to the beginning in a continuous loop.

Although only 24 lines long if Rems are



omitted, the program contains some interesting graphics techniques; in particular a double-density plotting routine and a realistic explosion, both of which can be incorporated into other programs.

Line 180 contains the Poke codes for the four graphics characters used in the fire-missile routine, putting them in the array C(). CS is the location of the centre of the screen and CF the degrees-to-radians conversion factor.

After Poking the centre of the screen with the compass-point symbols, the target's relative position is set using A to define its angle clockwise from the North. Note that A is a multiple of 10 between 0

and 350 inclusive. T is the Poke location of the target's centre. The input angle B\$ is tested for acceptable format, and then rounded to the nearest 10 degrees (B) before being compared to A.

The missile's horizontal and vertical displacements from the centre of the screen are denoted by X and Y which are incremented by S and C respectively in a 20-step For-Next loop. PO and PN are the missile's old and new locations:

$$F\% = \text{Peek}(PN)$$

ensures that no portions of the compass point or targets are inadvertently blown away.

The method to select the correct graphic symbol for the missile makes use of the fact that each relational statement has a numerical value: any true statement has the value -1 and any false statement has the value 0. Type ?3 < 5 return, and the Pet responds with the answer -1. Type ?6 < 4, and you will obtain 0. Thus the function

$$F = 1 - (X - \text{INT}(X) < .5) - 2 * (Y - \text{INT}(Y) < .5)$$

(see line 450)

takes values from 1 to 4 inclusive according to whether $X = \text{INT}(X)$ and $Y = \text{INT}(Y)$ are less than or greater than 0.5.

Now $X - \text{INT}(X)$ and $Y - \text{INT}(Y)$ give the fractional parts of X and Y, so we have a simple method of selecting the correct quarter of each pixel in which to place the missile:

DX < .5	DX > .5
DY > .5	DY > .5
F = 2	F = 1
DX < .5	DX > .5
DY < .5	DY < .5
F = 4	F = 3

where $DX = X - \text{INT}(X)$
 $DY = Y - \text{INT}(Y)$

So by defining C(1) as the Poke code for \blacksquare , C(2) for \blacksquare , etc., in line 180, we can Poke the missile into the correct quarter of each square.

The explosion subroutine is a very useful and effective one and can be used in many graphics programs. After Reading

Program 1. Bearings

```

150 REM*** INITIALISE ***
160
170 BL$=""
180 C(1)=124 C(2)=126 C(3)=108 C(4)=123 CS=33268 CF=PI/180
190 PRINT"C":POKECS,86:POKE33228,93:POKE33308,93:POKE33267,64:POKE33269,64
200
210 REM*** SET UP TARGET ***
220
230 A=INT(RND(1)*35+.5)*10:T=CS+INT(14*SIN(A*CF))-40*INT(10*COS(A*CF))
240 POKET,170:POKET-41,60:POKET+39,60:POKET-39,62:POKET+41,62
250
260 REM*** INPUT ANGLE: TEST FOR CORRECT FORMAT ***
270
280 INPUT"WHAT ANGLE "BL$,B$
290 IFVAL(B$)=0ANDVAL(B$)<360THEN320
300 PRINT"ANGLE BETWEEN 000 AND 359, PLEASE!"
310 FORI=1TO2000:NEXT:PRINT"BL$:PRINTBL$:GOTO280
320 IFLEN(B$)=3THEN370
330 PRINT"YOU MUST USE 3 FIGURES!":GOTO310
340
350 REM*** TEST FOR HIT/MISS ***
360
370 B=10*INT(VAL(B$)/10+.5):IFB=360THENB=0
380 IFA=BTHENPRINT"3 CORRECT ":GOTO410
390 PRINT"SORRY, YOU'VE MISSED!"
400
410 REM*** FIRE MISSILE ***
420
430 S=.7*SIN(B*CF):C=COS(B*CF)/2:X=0:Y=0:PO=CS:F% =86
440 FORI=1TO20:X=X+S:Y=Y+C:PN=CS+INT(X)-40*INT(Y)
450 POKEPO,F%:F%=PEEK(PN):POKEPN,C(1)-(X-INT(X)<.5)-2*(Y-INT(Y)<.5)
460 PO=PN:NEXT:POKEPO,F%:IFB=ATHENGOSUB510
470 FORI=1TO2000:NEXT:GOTO190
480
490 REM*** EXPLOSION ***
500
510 RESTORE FORI=1TO10:READE
520 POKET,E:POKET-40,E:POKET-41,E:POKET-2,E:POKET-1,E:POKET+39,E
530 POKET+40,E:POKET+41,E:POKET+1,E:POKET+2,E:POKET-39,E
540 NEXT RETURN
550 DATA160,32,160,32,160,35,42,43,46,32

```

the Poke code of each character, line 510, the character is Poked into the target area, the map below showing the relative positions of each pixel. T is the centre of the target.

	T-41	T-40	T-39	
T-2	T-1	T	T+1	T+2
	T+39	T+40	T+41	

This produces an explosion covering 11 pixels — clearly, the method can be extended to an area of any size. Experiment with your own characters — the data given in line 550 is only a suggestion.

The second of these two programs designed to give practice in the use of three-figure bearings takes the form of a real-time game in which the player has to guide a sailing boat in a figure-of-eight course around two islands in an estuary.

When the game begins, the boat, represented by a flashing dot on the screen, is due south of the larger island and sailing due east — 090 degrees. As soon as the player wishes to change course, he types in the required bearing. Corrections to the first two digits may be made using the Delete key, but once three digits have been typed, the new course is accepted immediately — provided it lies between 000 and 359.

The time taken is continuously displayed, as is the boat's status — changing from Green to Red if it sails too close to land. As soon as the course is completed, the total time taken is displayed, together with the best time achieved so far. With practice, a time of about 80 seconds is possible — 100 being about average — for the figure-eight course.

The program uses the same double-density graphics technique used in program 1 to achieve the movement of the

boat. Line 170 contains the codes for these graphics symbols in (C); BT\$ is the best time, CH the cursor-home screen location.

Lines 190 to 420 produce the map, relying mainly on Poking the characters into the appropriate places. For this type of operation, I prefer to use Poke rather than Print, finding reverse-video graphics fiddly and the cursor-control problems associated with 40-character lines tiresome. Provided the map is sketched first on a 40-by-25 grid numbered from 0 to 39 across the top, and 0 to 960 in steps of 40 down the side, it is not difficult to Poke into the required locations. Certainly, you should find it easier to interpret the program listing as it stands rather than the corresponding Print statements. Note that Poke can be entered as P shifted-O; Next as N shifted-E; and so on. Hence the occasional line with more than 80 characters.

Line 460 sets the starting direction, defined by B; S, C, X, Y, PO and PN are used as in program 1. SP is the location of the starting position — which will take a new value each time a new course is set: N is the number of digits of the new course accepted at any stage; B\$ the string expression containing these digits; T\$ holds the value of TIS — used in line 750 to check whether a time update is required.

Line 580 scans the keyboard for any potential change of course, any key depression being processed between lines 590 and 660. Corrections to previous digits are made possible by looking for the Delete key in line 600. 20 being the ASCII code for Delete.

Once a suitable three-digit number has been accepted, the course correction is

made in lines 700-710. R is a flag to indicate status. R = 0 enables a new position to be calculated — line 810. R being given the value of 1 in line 950 if the status changes to Red.

After updating the time, the boat's new position, PN, is calculated — line 810. The rather elaborate collision check — line 850 — is needed to eliminate the possibility that the new square, PN, is the same as the old — which happens frequently using the double-density plotting technique. If the new position is found to be acceptable, it is plotted, line 900, and the program loops back to 580 to look for a key depression.

The plot — new — position subroutine — lines 1110-1120 — contains two short delay loops

```
FOR I = 1 TO 100: NEXT
```

which govern the speed at which the boat moves. By reducing these delays the action can be speeded up if required, but most players will find this satisfactory.

In line 940. Peek(PN) = 58 looks for the finishing line. If not found, the status Red is printed, and the program loops back to line 580. When the finishing line is reached, the program moves into the end routine, lines 990-1070, printing the best time, and giving the option of another game.

Few programs of this type are ever completely finished, and further developments of this game are, of course, possible. One pupil suggested littering the bay with a few wrecks.

On a more serious level, an alternative method of controlling the course of the sailing boat would be to use Input statements to give the direction and magnitude of each leg of the course, thus reinforcing work on vectors.

Program 2. Sail-race.

```
150 REM** INITIALISE & PRINT MAP **
160 :
170 C(1)=124 C(2)=126 C(3)=108 C(4)=123:BT$="10000":CH=32768
180 BL$="" REM** 39 SPACES **
190 PRINT":":FOR I=CHTOCH+9:POKE I,160:NEXT:FOR I=CH+10TOCH+24:POKE I,99:NEXT
200 POKECH+25,95:FOR I=CH+26TOCH+48:POKE I,160:NEXT:POKECH+49,105
210 FOR I=CH+60TOCH+86:POKE I,160:NEXT:POKECH+87,105:POKECH+88,95:POKECH+109,160
220 POKECH+110,105:POKECH+111,95:FOR I=CH+112TOCH+126:POKE I,160:NEXT
230 FOR I=CH+152TOCH+166:POKE I,160:NEXT:POKECH+167,223:POKECH+191,233
240 FOR I=CH+192TOCH+207:POKE I,160:NEXT:FOR I=CH+231TOCH+243:POKE I,160:NEXT
250 POKECH+244,105:POKECH+245,95:POKECH+246,160:POKECH+247,105:POKECH+271,95
260 FOR I=CH+272TOCH+283:POKE I,160:NEXT:POKECH+292,233:FOR I=CH+293TOCH+295
270 POKE I,160:NEXT:POKECH+296,223:POKECH+314,95:FOR I=CH+315TOCH+322:POKE I,160:N
EXT
280 POKECH+323,105:POKECH+337,223:POKECH+357,95:FOR I=CH+358TOCH+360:POKE I,160:N
EXT
290 POKECH+361,105:POKECH+372,95:POKECH+376,160:POKECH+377,160:POKECH+399,95
300 POKECH+415,160:POKECH+414,160:POKECH+415,105:POKECH+425,233:POKECH+426,160
310 POKECH+427,160:POKECH+428,223:POKECH+462,233:FOR I=CH+463TOCH+469:POKE I,160
NEXT
320 POKECH+470,223:FOR I=CH+502TOCH+510:POKE I,160:NEXT:POKECH+542,95:FOR I=CH+543
TOCH+550
330 POKE I,160:NEXT:POKECH+551,223:FOR I=CH+583TOCH+591:POKE I,160:NEXT
340 FOR I=CH+623TOCH+626:POKE I,160:NEXT:POKECH+627,105:POKECH+629,95:POKECH+630
160
350 POKECH+631,105:POKECH+663,95:POKECH+664,160:POKECH+665,105
360 POKECH+400,101:FOR I=CH+439TOCH+799:STEP40:POKE I,103:POKE I+1,101:NEXT
370 POKECH+839,103:POKECH+840,76:POKECH+879,122:FOR I=CH+841TOCH+878:POKE I,100:N
EXT
380 FOR I=CH+704TOCH+864:STEP40:POKE I,58:NEXT
390 PRINT":3000  A I N##### A N D
400 PRINT":0000#####
410 PRINT":##### I G#### A M:
420 PRINT":#####R T/FINISH"
430 :
440 REM** WAIT AT START **
450 :
460 S=.35:XS=S:C=0:Y=C:FN=CH+785:PO=PN:SP=PN:N=0:B$="" E=0:2 T$="000000"
470 PRINTAT(10):PRESS "S" TO START"
480 POKE SP,C(3):FOR I=1TO150:NEXT
490 GETA:IFA#C(3) THEN540
500 POKESP,32:FOR I=1TO150:NEXT:GOTO480
510 :
520 REM** START MOVEMENT **
530 :
540 TIS="000000" PRINT": TIME 0 S. COURSE 000 STATUS GREEN"
550 :
560 REM** TEST FOR VALID INPUT **
570 :
580 GETA:IFA#C(3) THEN750
590 IF VAL(B$) < 0 OR A$ = "0" THEN620
600 IF A#C(CHR$(20)) OR N=0 THEN750
610 PRINT":TAB(20)+N" "N=N-1:B$=LEFT$(B$,N) GOTO750
620 N=N+1:IF N=1 THENPRINT":TAB(21)"
630 PRINT":TAB(20)+N:A$=B$+A$ IF N=3 THEN750
640 IF VAL(B$) < 360 THEN700
650 PRINT" ANGLE BETWEEN 000 AND 359, PLEASE!":FOR I=1TO250:NEXT
660 PRINTBL$":TAB(21)" "N=N-1:B$="" GOTO750
670 :
680 REM** SET NEW COURSE **
690 :
700 B$=VAL(B$)/99:180 SP=PO:N=0:B$="" S=.35*S:INC(B):C=COS(B)/4 R=0
710 X=X-INT(X)*Y=Y-INT(Y)
720 :
730 REM** TIME UPDATE **
740 :
750 IF T=TIS THEN810
760 TAB$=STR$(VAL(MID$(TIS,3,2))*60+VAL(RIGHT$(TIS,2)))
770 PRINT":TAB(9-LEN(TAB$)):TAB$ T$=TIS
780 :
790 REM** CALC NEW POSITION **
800 :
810 IF R=0 THENX=X+S:Y=Y+C:PN=SP+INT(X)-40+INT(Y)
820 :
830 REM** CHECK FOR COLLISION **
840 :
850 P=PEEK(PN) IF P=32 AND P=124 AND P=126 AND P=108 AND P=123 THEN940
860 IF PEEK(33726)=160 THENPRINT":TAB(34)" "GREEN"
870 :
880 REM** PLOT NEW POSITION **
890 :
900 GOSUB1110 GOTO580
910 :
920 REM** COLLISION **
930 :
940 IF PEEK(PN)=58 THENGOSUB1110 GOTO950
950 R=1:PRINT":TAB(34)" "RED" GOTO580
960 :
970 REM** END ROUTINE **
980 :
990 PRINT":BL$ PRINTTAB(7-LEN(TAB$))"FINISHED! YOU TOOK"TAB$" SECONDS. "
1000 FOR I=1TO2500:NEXT
1010 IF VAL(TAB$) < VAL(BT$) THEN1070
1020 PRINT" IT IS THE BEST TIME SO FAR. ",BT$=TAB$
1030 FOR I=1TO2500:NEXT:PRINT"AGAIN? Y/N"
1040 GETA:IFA#C(3) AND A#C(3) THEN1040
1050 IFA#C(3) THENPRINT":":END
1060 PRINTBL$:PRINTBL$:TAB$=POKEPN,58:GOTO460
1070 PRINT"THE BEST TIME IS"BT$" SEC. ",GOTO1030
1080 :
1090 REM** PLOT NEW POSITION **
1100 :
1110 POKEPN,32:FOR I=1TO100:NEXT:POKEPN,C(1)-(X-INT(X)*.5)-20*(Y-INT(Y)*.5)
1120 FOR I=1TO100:NEXT:PO=PN:RETURN
```

Your search for the right price stops here.

FLOPPY DISKS WHOLESALE PRICES

**MAIL
ORDER
LOW
PRICES**

Verbatim

MEMOREX



5 1/4" DISKETTES	VERBATIM	MEMOREX	DYSAN	Egly library type box holds 10 disks £2.30 for 5 1/4 £2.50 for 8 ins. plastex binders. Bins (capacity 20) £14.00 1/4 ins. (capacity 20) £11.00 desk storage boxes 8 ins. (holds 70) £26.45 5 1/4 ins. (holds 70) £20.75
ss/sd	£1.45ea	£1.42ea	£1.56ea	
ss/dd	£1.45ea	£1.42ea	£1.56ea	
ds/sd	£2.15ea	£2.12ea	£2.28ea	
dd/ds	£2.15ea	£2.12ea	£2.28ea	
Sold in boxes of 10. (Multiply these prices by 10 to arrive at box price). All disks carry our registered trade mark.				
8" DISKETTES	VERBATIM	MEMOREX	DYSAN	
ss/sd	£1.45ea	£1.42ea	£1.56ea	
ss/dd	£2.15ea	£2.14ea	£2.41ea	
ds/sd	£2.35ea	£2.32ea	£N/A	
dd/ds	£2.35ea	£2.32ea	£2.94ea	
Flippy ds/sd	£2.70ea (reversible-single density 26-128byte sectors)			

ORDERING INFORMATION

All prices are exclusive of V.A.T. Post and packing. Please remember to add 15% vat and 95p post/packing per 10 pack of disks, 65p for every subsequent 10 pack, Egly floppy disk storage box 5 1/4-8 ins p/p 45p each. Plastex binders 5 1/4-8 ins p/p 95p each, Desk storage boxes 5 1/4-8 ins — p/p £1.40 each.

ATTENTION

We are the only company that we know of that will supply floppy disks in 2s, 4s etc. If you require 2 add 27% to ten off price, 4 disks add 22%, 6 disks add 17%, 8 disks add 12%.

METHODS OF PAYMENT

Please make all cheques payable to CAAP Ltd, if you are a large establishment and cannot raise cheques without an invoice, then please send your order, and we will send a proforma invoice by return, for your accounts dept to pay against.

Please send your cheques/orders

CAAP LTD

45 Queensway
Caversham Park Village
Reading Berks RG4 0SJ

ORDER FORM				
Please send me				
QTY	ITEM	PRICE	VAT	TOTAL
			post, packing & insurance _____	
			I enclose cheque payable to CAAP LTD. for £ _____	
NAME _____				
ADDRESS _____				
TEL. NO. _____				

PC7/81

● Circle No. 150

Make the most of your Sinclair ZX Computer...

Sinclair ZX software on cassette.

£3.⁹⁵ per cassette.



The unprecedented popularity of the ZX Series of Sinclair Personal Computers has generated a large volume of programs written by users.

Sinclair has undertaken to publish the most elegant of these on pre-recorded cassettes. Each program is carefully vetted for interest and quality, and then grouped with other programs to form a single-subject cassette.

Each cassette costs £3.95 (including VAT and p&p) and comes complete with full instructions.

Although primarily designed for the Sinclair ZX81, many of the cassettes are suitable for running on a Sinclair ZX80 – if fitted with a replacement 8K BASIC ROM.

Some of the more elaborate programs can be run only on a Sinclair ZX Personal Computer augmented by a 16K-byte add-on RAM pack.

This RAM pack and the replacement ROM are described below. And the description of each cassette makes it clear what hardware is required.

8K BASIC ROM

The 8K BASIC ROM used in the ZX81 is available to ZX80 owners as a drop-in replacement chip. With the exception of animated graphics, all the advanced features of the ZX81 are now available on a ZX80 – including the ability to run much of the Sinclair ZX Software.

The ROM chip comes with a new keyboard template, which can be overlaid on the existing keyboard in minutes, and a new operating manual.

16K-BYTE RAM pack

The 16K-byte RAM pack provides 16-times more memory in one complete module. Compatible with the ZX81 and the ZX80, it can be used for program storage or as a database.

The RAM pack simply plugs into the existing expansion port on the rear of a Sinclair ZX Personal Computer.



Cassette 1 – Games

For ZX81 (and ZX80 with 8K BASIC ROM)

ORBIT – your space craft's mission is to pick up a very valuable cargo that's in orbit around a star.

SNIPER – you're surrounded by 40 of the enemy. How quickly can you spot and shoot them when they appear?

METEORS – your starship is cruising through space when you meet a meteor storm. How long can you dodge the deadly danger?

LIFE – J. H. Conway's 'Game of Life' has achieved tremendous popularity in the computing world. Study the life, death and evolution patterns of cells.

WOLFPACK – your naval destroyer is on a submarine hunt. The depth charges are armed, but must be fired with precision.

GOLF – what's your handicap? It's a tricky course but you control the strength of your shots.

Cassette 2 – Junior Education: 7-11-year-olds

For ZX81 with 16K RAM pack

CRASH – simple addition – with the added attraction of a car crash if you get it wrong.

MULTIPLY – long multiplication with five levels of difficulty. If the answer's wrong – the solution is explained.

TRAIN – multiplication tests against the computer. The winner's train reaches the station first.

FRACTIONS – fractions explained at three levels of difficulty. A ten-question test completes the program.

ADDSUB – addition and subtraction with three levels of difficulty. Again, wrong answers are followed by an explanation.

DIVISION – with five levels of difficulty. Mistakes are explained graphically, and a running score is displayed.

SPELLING – up to 500 words over five levels of difficulty. You can even change the words yourself.

Cassette 3 – Business and Household

For ZX81 (and ZX80 with 8K BASIC ROM) with 16K RAM pack

TELEPHONE – set up your own computerised telephone directory and address book. Changes, additions and deletions of up to 50 entries are easy.

NOTE PAD – a powerful, easy-to-run system for storing and

retrieving everyday information. Use it as a diary, a catalogue, a reminder system, or a directory.

BANK ACCOUNT – a sophisticated financial recording system with comprehensive documentation. Use it at home to keep track of 'where the money goes,' and at work for expenses, departmental budgets, etc.

Cassette 4 – Games

For ZX81 (and ZX80 with 8K BASIC ROM) and 16K RAM pack

LUNAR LANDING – bring the lunar module down from orbit to a soft landing. You control attitude and orbital direction – but watch the fuel gauge! The screen displays your flight status – digitally and graphically.

TWENTYONE – a dice version of Blackjack.

COMBAT – you're on a suicide space mission. You have only 12 missiles but the aliens have unlimited strength. Can you take 12 of them with you?

SUBSTRIKE – on patrol, your frigate detects a pack of 10 enemy subs. Can you depth-charge them before they torpedo you?

CODEBREAKER – the computer thinks of a 4-digit number which you have to guess in up to 10 tries. The logical approach is best!

MAYDAY – in answer to a distress call, you've narrowed down the search area to 343 cubic kilometers of deep space. Can you find the astronaut before his life-support system fails in 10 hours time?

Cassette 5 – Junior Education: 9-11-year-olds

For ZX81 (and ZX80 with 8K BASIC ROM)

MATHS – tests arithmetic with three levels of difficulty, and gives your score out of 10.

BALANCE – tests understanding of levers/fulcrum theory with a series of graphic examples.

VOLUMES – 'yes' or 'no' answers from the computer to a series of cube volume calculations.

AVERAGES – what's the average height of your class? The average shoe size of your family? The average pocket money of your friends? The computer plots a bar chart, and distinguishes MEAN from MEDIAN.

BASES – convert from decimal (base 10) to other bases of your choice in the range 2 to 9.

TEMP – Volumes, temperatures – and their combinations.

How to order

Simply use the order form below, and either enclose a cheque or give us the number of your Access, Barclaycard or Trustcard account. Please allow 28 days for delivery. 14-day money-back option.

Sinclair ZX SOFTWARE

Sinclair Research Ltd,
6 Kings Parade, Cambridge,
Cams., CB2 1SN. Tel: 0276 66104.

To: Sinclair Research, FREEPOST 7, Cambridge, CB2 1YY

Please print

Please send me the items I have indicated below.

Qty	Code	Item	Item price	Total
	21	Cassette 1 – Games	£3.95	
	22	Cassette 2 – Junior Education	£3.95	
	23	Cassette 3 – Business and Household	£3.95	
	24	Cassette 4 – Games	£3.95	
	25	Cassette 5 – Junior Education	£3.95	
	17	*8K BASIC ROM for ZX80	£19.95	
	18	*16K RAM pack for ZX81 and ZX80	£49.95	
		*Post and packing (if applicable)	£2.95	
			Total £	

*Please add £2.95 to total order value only if ordering ROM and/or RAM.

I enclose a cheque/PO to Sinclair Research Ltd for £ _____

Please charge my Access*/Barclaycard/Trustcard no. _____

*Please delete as applicable.

Name: Mr/Mrs/Miss _____

Address: _____

PRC 12

We proudly announce the arrival of
the computer-frame
you have been waiting for

pearcom[®]

A new Europe-PAL microcomputer frame.

NOW AVAILABLE £ 975 excluding VAT

Main features:

- large amount of compatible software already available
- interactive cards, firmware & hardware available everywhere
- 14 I/O expansion slots as standard
- screen size: 24 lines of 40 characters, Upper and Lower case with optional card expansion to 24 lines of 80 characters.
- 32k byte of RAM standard, on board expandable to 96k byte
- uses the popular 6502 CPU
- bus compatible with the Z80 Firmware Card with CPM and Microsoft BASIC
- Programming languages including BASIC, Fortran and Cobol etc., are available separately
- full PAL-colour video supplied as standard with sound through TV
- professional keyboard with function keys and number pad
 - Character set with 255 characters in reprogrammable EPROM, delivered standard with Upper and Lower Case characters, Greek and pseudo graphics, and a jumper selectable choice of QWERTY or AZERTY
 - For optional extra's such as an EPROM-programmer, microphone, joystick etc., there is a special lid beside the keyboard for user hardware
 - A sturdy, light weight four-piece moulded case of strong polyurethane in two colours beige/black.



DEALER INQUIRIES INVITED



pearcom[®]

PEARCOM LTD. 17 Nobel Square, Basildon Essex SS 13 1LP England Tel. 0268 - 728484 Tlx. 995323
PEARCOM B.V. i.o. Stationstraat 1a 6241 CL BUNDE (L), Netherlands Tel. 043 - 647899

Standard marks

Combining sets of examination marks with different means can involve hours of laborious calculation. Ian Mercer describes a simple program which can be adapted to standardise any set of statistics.

EDUCATORS often need to find a total for marks for several different subjects, and to compare how well pupils are doing at different subjects at a school.

Using the actual marks can be confusing. For instance, you cannot compare how well someone is doing in mathematics with their English if the maths marks have a mean of 80 and the English marks have a mean of 40. Adding these two sets of marks to obtain a total would give an unfair bias to maths.

To overcome these difficulties the marks can be standardised. This process gives each subject the same mean and standard deviation or SD. Marks from any two subjects can then be totalled or compared fairly. Standardising marks also makes it easier to measure progress — each term's marks will have the same mean and standard deviation.

Standardising is a simple process using a computer. First you must calculate the original mean and SD for each subject. Then you take each mark for that subject in turn, subtract the mean, and divide by the SD. This produces a set of marks with mean=0, SD=1. Next you multiply by the new SD and add the new mean. This process takes place in lines 590-610 of the computer program, as shown in figure 1.

The first section of the program inputs marks for the three subjects taken in the entrance exam at my school, Loughborough Grammar. One important tip for Pet users is the use of Input #1 after an Open 1,1,0. This prevents you from accidentally carriage returning and finding yourself back in Basic.

The subroutine at 10000 may look

(continued on next page)

Figure 1. Standardising a normal distribution of marks.

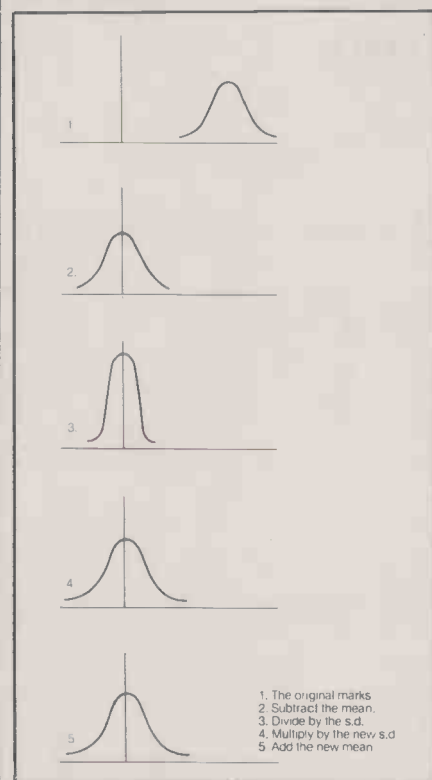

```

10 PRINT "MARKS PROGRAM"
20 PRINT "-----"
30 PRINT:PRINT:PRINT:PRINT:PRINT:PRINT:PRINT
40 REM PROGRAM TO STANDARDISE
50 REM ENTRANCE EXAM MARKS.
60 REM BY I.MERCER 9/2/81
70 REM
80 REM DATE
90 DA$="FEBRUARY 1981"
100 REM MEAN MARK AFTER STAND.
110 SM=50
120 REM STANDARD DEVIATION AFTER STAND.
130 SD=15
140 REM USE AN INPUT FILE TO PREVENT
141 REM ACCIDENTAL <RETURNS>.
150 OPEN 1,0,0
160 REM SUBJECT NAMES
170 SU$(1)="ENGLISH":SU$(2)="MATHS":SU$(3)="I.O."
180 P$="#####"
190 D$="#####"
200 REM INPUT NUMBER OF CANDIDATES
210 PRINT "HOW MANY CANDIDATES?"
220 INPUT #1,N$:N=VAL(N$):PRINT
230 IF N<2 THEN PRINT "WRONG - TRY AGAIN!" GOTO 210
240 IF N<INT(N) THEN PRINT "WHOLE CANDIDATES ONLY!" GOTO 210
250 REM DIMENSION THE ARRAY
260 DIM A(N,7),S(2,3)
270 REM A(X,0) = POSITION
280 REM A(X,1) = ENGLISH
290 REM A(X,2) = MATHS
300 REM A(X,3) = I.O.
310 REM A(X,4) = ENGLISH STAND.
320 REM A(X,5) = MATHS STAND.
330 REM A(X,6) = I.O. STAND.
340 REM A(X,7) = TOTAL (MATHS + ENGLISH)
350 REM NOW INPUT THE MARKS
360 FOR SU=1 TO 3
370 PRINT "INPUT ";SU;" MARKS"
380 PRINT:PRINT
390 FOR X=1 TO N
400 GOSUB 10000
410 NEXT X
420 PRINT P$ "IS IT CORRECT?":D$
430 INPUT #1,A$:IF LEFT$(A$,1)="" THEN 510
440 IF LEFT$(A$,1)="" THEN 420
450 REM CORRECT A MARK
460 PRINT P$: "WHICH CANDIDATE?":D$
470 INPUT #1,A$:X=VAL(A$)
480 IF X<1 OR X>3 THEN 420
490 A(X,SU)=A(0,SU)-A(X,SU)+A(0,SU+3)-A(X,SU)*A(X,SU)
500 GOSUB 10000:GOTO 420
510 NEXT SU
520 REM MARKS INPUT - BEGIN CALCULATIONS
530 FOR SU = 1 TO 3
540 S(1,SU)=A(0,SU)/N
550 S(2,SU)=SQR(A(0,SU+3)/N-S(1,SU)*S(1,SU))
560 NEXT SU
570 FOR X = 1 TO N
580 FOR SU = 1 TO 3
590 A=(A(X,SU)-S(1,SU))/S(2,SU)
600 A=A*SS+SM
610 A(X,SU+3)=INT(A+.5)
620 NEXT SU:A(X,7)=A(X,4)+A(X,5)
630 NEXT X
640 REM PRINT OUT RESULTS
650 REM OPEN FILE TO PRINTER
660 OPEN 4,4
670 PRINT "##### LINE PRINTER UP TO TOP OF PAGE"
680 PRINT " AND PRESS <RETURN>"
690 GET A$:IF A$<>CHR$(13) THEN 690
700 PRINT #4
710 PRINT #4,SPC(20);CHR$(1);"ENTRANCE EXAMINATION"
711 PRINT #4,SPC(20);CHR$(1);"-----"
720 PRINT #4,SPC(20);CHR$(1);" RESULTS "
721 PRINT #4,SPC(20);CHR$(1);"-----"
730 PRINT #4,SPC(60);DA$:PRINT #4
740 PRINT #4," ENGLISH MATHS I.O."
750 PRINT #4," NO."
760 FOR TT = 1 TO 3:PRINT #4," TRUE SCALED POSN ";NEXT TT
770 PRINT #4," TOTAL POSITION"
780 PRINT #4
790 REM NOW PRINT OUT ACTUAL MARKS
800 FOR X = 1 TO N
810 PRINT #4,RIGHT$( " "STR$(X)+ " ",5);

```

(listing continued on next page)

(continued from previous page)

daunting for non-Pet users, but the cursor commands are only laying out the marks neatly on the screen as they are input. These could be replaced by HTAB and VTAB on the Apple or equivalent, or omitted.

As the marks are input, they are totalled up in the zero element of the array — see line 10050. But remember that if a mark is altered you must correct these totals — see line 490. When all the marks have been input, the program calculates the mean and SD for each subject — see lines 530-560 and stores them in an array S(.). Next it standardises the marks. For this entrance exam the total does not include the IQ paper; line 620 totals the maths and English marks.

Now the results are output to the printer — any printer offering 80 columns or more will do. Extensive formatting in the form of Right\$() is used to ensure a neat table with right-justified numbers. The program also calculates the positions in each subject and the overall position.

This section of the program takes the longest to run, but since it is only run once a year I did not think it was worth using machine code, which would have gained speed at the expense of readability of the program.

For reference, the program also prints out the original mean and standard deviation for each subject.

It then calculates a product-moment correlation coefficient. This can take a value from -1 to +1. For exam results it should be positive and above about 0.5.

A sample run using random numbers generated by the Pet is shown in figure 2.

(listing continued from previous page)

```

820 FOR SU = 1 TO 3
830 PRINT#4,RIGHT#(" "+STR$(A(X,SU))+"" " 6)
840 PRINT#4,RIGHT#(" "+STR$(A(X,SU+3))+"" " 6)
850 P%=1:EX=0:MA=A(X,SU)
860 FORT=1TON
870 IFA(X,SU)<MATHENP00
880 IFA(X,SU)>MATHENP%=P%+1:GOTO900
890 EX=EX+1
900 NEXTT
910 PRINT#4,RIGHT#(" "+STR$(P%),4)
920 IFEX>1THENPRINT#4,"=" " "GOTO940
930 PRINT#4," "
940 NEXTSU
950 PRINT#4,RIGHT#(" "+STR$(A(X,7))+"" " 7)
960 P%=1:EX=0:MA=A(X,7)
970 FORT=1TON
980 IFA(X,7)<MATHENI010
990 IFA(X,7)>MATHENP%=P%+1:GOTO1010
1000 EX=EX+1
1010 NEXTT
1020 PRINT#4,RIGHT#(" "+STR$(P%),6)
1030 IFEX>1THENPRINT#4,"="
1040 PRINT#4
1050 NEXT X
1060 FORT=1TO4:PRINT#4:NEXT
1070 PRINT#4,SPC(15):"ORIGINAL MEAN":SPC(17):"ORIGINAL S.D."
1071 PRINT#4,SPC(15):""SPC(17):"
1080 FORSU=1TO3
1090 PRINT#4,SPC(5):SU$(SU):SPC(7):LEFT$(STR$(S(1,SU))+" " 5)
1100 PRINT#4,SPC(25):LEFT$(STR$(S(2,SU))+" " 5)
1110 NEXT SU
1120 FORT=1TO4:PRINT#4:NEXT
1130 REM NOW CALCULATE THE PRODUCT MOMENT CORRELATION COEFFICIENTS
1140 PRINT#4,SPC(21):"PRODUCT MOMENT CORRELATIONS"
1141 PRINT#4,SPC(21):"
1150 FORSU=1TO3
1160 OS=SU+1:IFOS=4THENOS=1
1170 TT=0
1180 FOR T = 1 TO N
1190 TT=TT+(A(T,SU)-S(1,SU))*(A(T,OS)-S(1,OS))
1200 NEXT T
1210 PRINT#4,SPC(21):SU$(SU):" - ":SU$(OS):" "
1220 PM=TT/N/(S(2,SU)*S(2,OS))
1230 PRINT#4,LEFT$(STR$(PM))+" " 4)
1240 NEXT SU
1250 FORT=1TO4:PRINT#4:NEXT
1260 END
10000 PRINT#4"CANDIDATE #":X:":":D#
10010 INPUT#1,N#:J=VAL(N#)
10020 IFJ<1ORJ>200ORJ<>INT(J)THEN10000
10030 PRINT#4"X":":FORT=1TON:PRINT"#####":NEXT:PRINT"#####":
10040 PRINTRIGHT#(" "+STR$(J),4)
10050 A(X,SU)=J:A(X,SU)=A(X,SU)+J:A(X,SU+3)=A(X,SU+3)+J
10060 RETURN

```

Figure 2. Sample results of program.

ENTRANCE EXAMINATION										
RESULTS										
FEBRUARY 1981										
NO.	ENGLISH			MATHS			I.Q.			TOTAL POSITION
	TRUE	SCALED	POSTN	TRUE	SCALED	POSTN	TRUE	SCALED	POSTN	
1	33	32	9	52	55	3	52	45	5	98
2	56	58	4	74	79	1	62	59	4	137
3	44	44	7	35	35	8=	50	44	7=	79
4	63	66	2	43	44	7	54	49	5	119
5	71	75	1	52	54	4=	50	44	7=	129
6	51	52	5=	44	45	6	68	66	2	97
7	29	26	10	52	54	4=	72	71	1	90
8	51	52	5=	29	27	10	50	44	7=	79
9	36	35	8	35	35	8=	65	62	3	70
10	58	60	3	56	59	3	29	15	19	119
	<u>ORIGINAL MEAN</u>			<u>ORIGINAL S.D.</u>			<u>PRODUCT MOMENT CORRELATIONS</u>			
ENGLISH	49.1			13.0			ENGLISH - MATHS	: .98		
MATHS	49.1			13.2			MATHS - I.Q.	: -.02		
I.Q.	55.1			11.9			I.Q. - ENGLISH	: -.45		

RACE NIGHT

An evening's entertainment, and a good profit for charity are ingredients of a typical race night. This program from Eric Parr removes much of the paperwork and adds to the atmosphere of the occasion.

SIMULATED horse races provide the entertainment at the popular fund-raising events known as race nights. The activity centres round filmed races — often from obscure American or Australian race courses.

After seeing the runners being paraded round the paddock, the punters place their bets. Winnings, amounting to 60 percent of the total staked, are paid out at the end of the race, calculated on the totaliser principle. The remaining 40 percent is retained for charity. Between six and 10 races are normally run in an evening.

The Race Night program was written for Wishaw Round Table to replace most of the tedious paperwork and calculations involved in a normal race night. The

Figure 1. Block diagram of Race Night program, including subroutines.

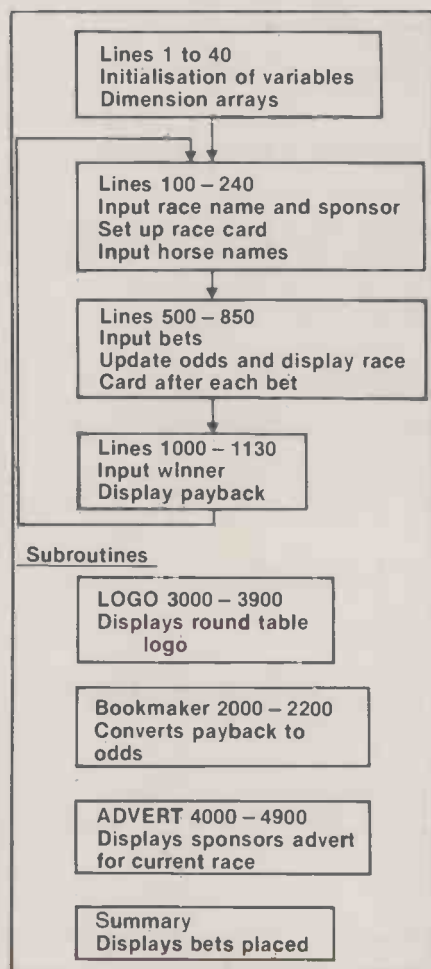

system is supported by "bookies' runners" as it was thought advisable to use betting slips to allow manual back-up if the computer crashed.

The program was tested on several dummy runs, but on the night it performed better than expected. The tote was run successfully by just two people — a typist and a dictator.

The system also added some atmosphere to the night by providing continuously-updated odds. In a normal race night, odds are only available after a race has been run. Odds for the winner of each race were given within seconds of the finish, compared with the 10 to 15 minutes which had been usual on previous race nights.

The essence of the program is quite simple. The payback — P — per bet is given by:

$$\frac{0.6 \times U \times T}{N}$$

where U is the unit bet, T the total number of bets placed and N the total bets placed on the winning horse.

The majority of the program is actually devoted to embellishments, which include a race card displaying the horses' names and current odds, a Round Table logo for "quiet" periods, and a one-page advertisement for each race sponsor between races.

The program falls neatly into four blocks — see figure 1. The first block simply dimensions the arrays used, reserves an area for the string arrays and sets the price of a bet.

The second block inputs the horses' names. These could have been stored in arrays for each race, but in practice most names are sold on the night, and it adds atmosphere to the event if the race card is built up on the VDU screens as horses are sold.

The third, and most important, block inputs the bets. A race card is displayed,

Figure 3. Signal splitter to drive four UHF televisions.

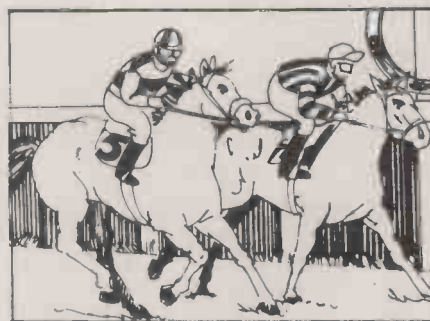
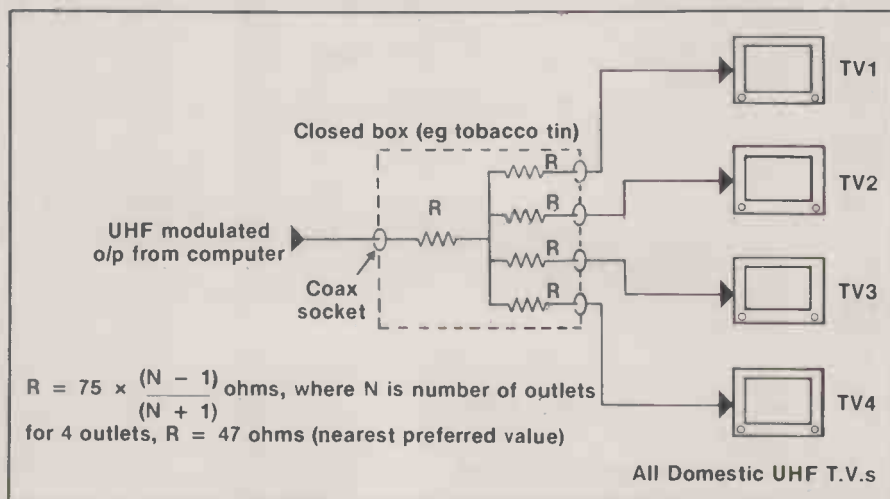

RACE 3 WISHAW PRESS STAKES

Number	Name	Approx Odds
1	Heat for Hire	3/2
2	British Steel	5/1
3	Mighty Micro	EVENS
4	Red Revolution	4/1
5	Practical	
	Computing	4/1
6	Chip Chop	6/1

Number of bets? 5
Horse number? 2

Figure 2. Race-card display.

with odds — see figure 2. The actual bookmakers' odds are calculated in the subroutine from lines 2000 to 2200. The pay-back per unit bet is given by the simple formula.

$$P = T/N$$

and includes the original stake.

Bookmakers' odds ignore the original stake, hence we start with

$$BM = P - 1.$$

Bookmakers express odds in the form 8/1 or 6/1 or 3/2. The variable J is used as a multiplier and incremented from 1 until the ratio

$$\text{INT}(BM \cdot J)/J$$

is within 10 percent of BM. The ratio is then a rough approximation to bookmakers' odds. Line 2005 prints a blank if the odds are less than 1 to 10. Line 2030 simply prints P - 1 for odds greater than 5 to 1. Line 2110 prints "Evens" if the calculated odds are 1 to 1.

(continued on next page)

Arrays

H\$(I) Horse name
 OD(I) Pay-back/bet should horse win
 B(I) Number of bets on horse
 O\$(I) Owner's name

Other variables

U Price/bet
 RC Race number
 SP\$ Sponsor's name
 RC\$ Race name
 K Number of horses in race
 B Input number of bets
 T Total bets in this race
 BM Bookmakers' odds
 J,B1 Value of odds, B1 to J
 Q\$ } Keyboard inputs
 A\$ }
 A Numerical version of A\$
 P Pay-back

(continued from previous page)

Bets are given by the runners in the form "four bets on horse 1, six bets on horse 3, etc.". These are entered at lines 620/660. Line 670 deliberately ignores a bet if an invalid horse number is entered. This allows a typing error to be skipped. In addition, negative bets can be entered to correct errors. As each bet is entered, an updated race card is produced on the VDUs.

The final main block gives the winning pay-back. When the winner is announced, the horse number is entered and confirmed upon which the pay-back per bet is given, rounded to 10p.

There are four subroutines. Bookmakers' odds has already been described. The subroutines for the Round Table logo or an advertisement, for the race sponsor, are called when required. They consist of simple Print statements and are not listed here.

The final subroutine, Summary, displays the bets on each horse in cryptic

form. It was included to warn the pay-out booth how many claims to expect.

The program was written for a Nascom-2. The UHF-modulated output is used to drive the monitors around the hall, and the 1.5V peak-to-peak video feeds a closed-circuit TV monitor for the keyboard operator. The simple splitter shown in figure 3 allows four TVs to be driven from the UHF output without loss of quality. As the Nascom uses the standard Astec modulator, similar results would probably be achieved with other machines.

The one computer-assisted race night we have held so far was most successful. Only one error was made during the night, and this was later found to have been caused by a forged ticket. In a normal race night an error of plus or minus one ticket per horse is reasonable, so the program was an improvement in this respect. The biggest gains, though, were in the atmosphere created and the general smooth running of the event.

Table 1. Variables used in program.

```

1  REMARKABLE RACE NIGHT PROGRAM          840  NEXT (I)
2  REMARKABLY WRITTEN FOR WISHAW ROUND TABLE 850  GOTO 510
3  CLS                                     1000  REM RESULT OF RACE
4  PRINT "Good Evening"                  1005  CLS
5  INPUT "Bet Unit ";U                   1010  INPUT "Winning Horse No";A
6  CLEAR 4000                             1012  PRINT "Confirm Horse No";A
7  DIM H$(15),OD(15), B(15), O$(15)     1014  PRINT "HORSE NAME";H$(A)
10  CLS                                    1016  INPUT Q$
12  INPUT Q$: IF Q$="LOGO" THEN GO SUB 3000: GOTO 1018
20  INPUT "Race Number";RC               1018  IF Q$<>"YES" GOTO 1000
25  IF RC> 6 OR RC<1 GOTO 20             1020  CLS:PRINT "Race"; RC;" ";RC$
30  INPUT "Race Name"; RC$              1025  PRINT:PRINT "Sponsored by "SP$
40  INPUT "Sponsor"; SP$                1026  PRINT
100  REM INPUT HORSES                    1030  PRINT " *****WINNER*****"
110  CLS                                  1040  PRINT
120  INPUT "Number of Horses";K          1050  PRINT "Horse Number";A;" ";H$(A)
130  IF K<4 OR K>12 THEN 110             1060  PRINT "Owner";O$(A)
135  FOR I=1 TO K:H$(I)=" ": NEXT I      1070  PRINT
140  CLS: PRINT "Race"; RC; " "; RC$     1080  P=0.6*U
145  PRINT "Number", "Name"             1090  OD(A)=(INT((10*(U*P+0.05))/B(A)))/10
150  FOR I=1 TO K                        1095  PRINT
160  PRINT I,H$(I)                       1100  PRINT "Payback/Bet ";OD(A)
170  NEXT I                               1110  INPUT Q$
180  PRINT                                1115  IF Q$="LOGO" THEN GOSUB 3000: GOTO 1110
190  INPUT "Horse Number";A$:A=VAL (A$)  1120  IF Q$="ADVERT" THEN GOSUB 4000: GOTO 1110
200  IF A$="BET" GOTO 500                 1130  GOTO 10
205  IF A$="ADVERT" THEN GOSUB 4000: GOTO 140
210  IF A$<>"ADVERT" THEN GOTO 140
220  A=INT (A)                            2000  REM WORK OUT BOOKMAKERS ODDS
230  INPUT "Name";H$(A)                  2005  IF OD(I)<1.1 THEN PRINT " ":RETURN
235  INPUT "Owner";O$(A)                 2010  BM=OD(I)-1
240  GOTO 140                             2020  J=1
500  REM TAKE BETS                        2030  IF BM> 5 THEN B1=INT(BM+0.5):GOTO 2100
502  T=0                                  2040  B1=BM*J
504  FOR I=1 TO K:B(I)=0:OD (I) = 0: NEXT I  2050  IF ABS(B1-INT(B1+0.5))<J/10 THEN GOTO 2100
510  CLS                                    2060  J=J+1
515  PRINT "Race"; RC; " ";RC$:PRINT     2070  GOTO 2040
520  PRINT "Number Name"; TAB (35);"APPROX ODDS"  2100  B1=INT(B1+0.5)
530  FOR I=1 TO K                        2110  IF B1=1 AND J=1 THEN PRINT "EVENS":GOTO 2200
540  PRINT I; TAB (7);H$(I);TAB(36);    2120  PRINT "B1";"/";J
550  GOSUB 2000                           2200  RETURN
560  NEXT I                               3000  REM DRAW ROUND TABLE LOGO
600  REM ACTUAL BETS MADE                 3010  REM OMITTED FOR BREVITY
610  PRINT                                3900  INPUT Q$:RETURN
620  INPUT "Number of Bets"; Q$          4000  REM DISPLAY ADVERTS
625  IF Q$="LOGO" THEN GOSUB 3000: GOTO 510  4010  CLS:PRINT "Race";RC;" ";RC$
630  IF Q$="ADVERT" THEN GOSUB 4000: GOTO 510  4020  PRINT "SPONSORED BY";SP$
635  IF Q$="SUM" THEN GOSUB 5000: GOTO 510  4030  ON RC GO SUB 4100:4200:4300:4400:4500:4600
640  IF Q$="RUN" GOTO 1000               4040  INPUT Q$: RETURN
650  B=VAL (Q$)                           4100  REM FIRST RACE ADVERT
655  IF B>9 GOTO 510                     4102  REM OMITTED FOR BREVITY
660  INPUT "Horse Number";A              4190  RETURN
670  IF A<1 OR A>K GOTO 510              4200  REM LINES 4200 TO 4690 ADVERTS FOR
680  T=T+B:B(A) = B(A)+B                 4210  REM OTHER RACES. OMITTED FOR BREVITY
800  REM WORK OUT PAYBACKS               5000  REM SUMMARY OF BETS
810  P=0.6*U                              5010  FOR I=1 TO K
820  FOR I=1 TO K                         5020  PRINT I;B(I)
830  OD(I)=(INT(100*P/B(I)))/100         5030  NEXT I
                                           5040  PRINT T
                                           5050  INPUT Q$:RETURN
    
```

who else offers you this service?

Training Either before or after you buy your microcomputer system. We provide in-depth training at the computer, with full supervision.

Hardware & Support
We supply the most suitable microsystem for your application and then fully maintain it at your premises.

Software
We have generalised software packages, but our team also prepare tailor-made software to meet your requirements.

Supplies
Your microsystem will require ribbons, diskettes, continuous stationery etc. We can always supply these from stock.



A chart showing some of our training courses.



The LONDON MICRO CENTRE

47 Lower Belgrave Street, London SW1 0LS

Telephone 01-730 8791

Contact us today for more information

The LONDON MICRO CENTRE Ltd
An EMG Company

NEC PC 8000 PERSONAL COMPUTER.

“THE ELECTRONICS ARE

VALUE FOR MONEY.”

PERSONAL COMPUTER WORLD.

Eight colour graphics, ten programmable function keys, a full qwerty keyboard with numeric key pad, alternative graphic and character sets, and superb editing facilities including definable scroll area.

Now at last you can have all the features you want in one expandable system with memory from 32K up to 190K for user applications and prototyping facilities for industrial and scientific use.

As well as powerful N-Basic by Microsoft,* full CPM compatibility gives access to a large library of software including Wordstar and compilers for Fortran, Pascal, Cobol and Basic 80 languages.

N-Basic packages are already available for sales, purchase and nominal ledgers, invoicing, stock control, payroll, information retrieval, and word processing.

And when you consider the cost/performance ratio, NEC is even further ahead.

The NEC PC8000 Personal Computer is available through your local dealer now. Complete the coupon or call the distributor IBR Microcomputers on Reading (0734) 664111 for the name of your nearest dealer.

*Microsoft is a trade mark.



IBR

MICROCOMPUTERS

Suttons Industrial Park, London Road, Earley, Reading.

Tel: 0734 664111. Telex: 848215.

A MEMBER OF THE IBR ELECTRONICS GROUP.

Please send me complete details on the NEC PC8000 series and the address of my local dealer.

Name _____
Company _____
Address _____
Tel. _____

EXCELLENT AND IT IS SUPERB



precision in miniature

New Series MT100 matrix printers



Only the size and price are small. Performance is big, like the list of standard features. The MT100 Series miniature matrix printer has traditional Mannesmann-Tally reliability built in from the start. It's light, quiet and easy to use — the perfect partner for small systems, interfaceable with most computers.

The MT120 gives a degree of sophistication not normally associated with mini printers. Standard features offered include:

9x7 matrix, 160 cps high speed output — often doubled by micro-processor control which chooses shortest print path in either direction; selectable 18x40 matrix for high definition correspondence quality; 10 different character sets, each with 96 characters; OCR A and B character fonts using 9x9 matrix; 80 to 132 cpl, 10 to 16.6 cpi; friction paper feed — ideal for correspondence — is standard with optional tractor feed available.

The MT110 is also available in the range offering 100 cps print speed and 7x7 character matrix.

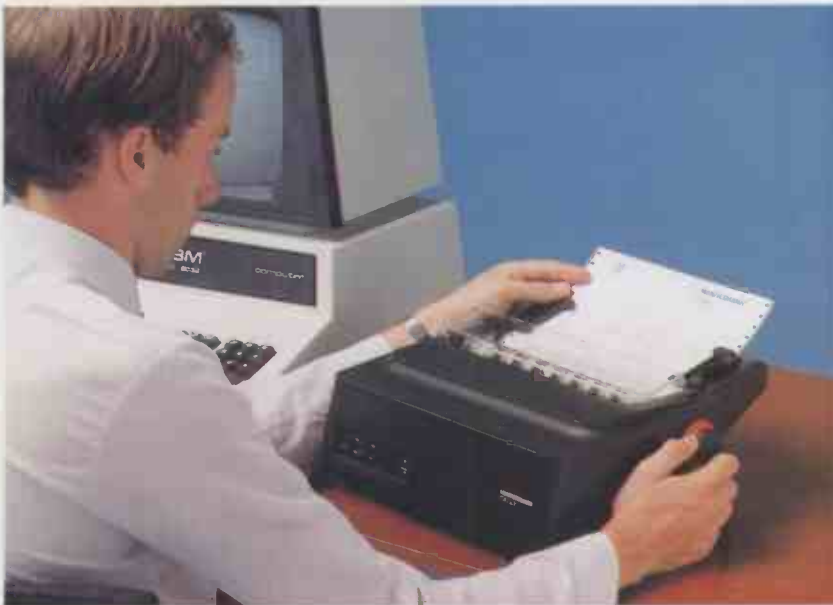

Printers for the long run



MANNESMANN
TALLY

● Circle No. 155

There's more. Contact Mannesmann-Tally Limited, 7 Cremyll Road, Reading, Berkshire. Tel: Reading (0734) 580141. Cables: Tally-Reading. Telex: 847028

The Twelve computerised Days of Christmas



On the first day of Christmas, my computer
gave to me
A glitch on the video screen.



On the second day of Christmas, my
computer gave to me
Two keyboard bounces,
And a glitch on the video screen.



On the third day of Christmas, my computer
gave to me
Three loose plugs,
Two keyboard bounces,
And a glitch on the video screen.



On the fourth day of Christmas, my
computer gave to me
Four garbled Saves,
Three loose plugs,
Two keyboard bounces,
And a glitch on the video screen.



On the fifth day of Christmas, my computer
gave to me
Five blank cassettes,
Four garbled Saves,
Three loose plugs,
Two keyboard bounces,
And a glitch on the video screen.



On the sixth day of Christmas, my computer
gave to me
Six I/O spasms,
Five blank cassettes,
Four garbled Saves,
Three loose plugs,
Two keyboard bounces,
And a glitch on the video screen.



On the seventh day of Christmas, my
computer gave to me
Seven system re-sets,
Six I/O spasms,
Five blank cassettes,
Four garbled Saves,
Three loose plugs,
Two keyboard bounces,
And a glitch on the video screen.



On the eighth day of Christmas, my
computer gave to me
Eight worthless printouts,
Seven system re-sets,
Six I/O spasms,
Five blank cassettes,
Four garbled Saves,
Three loose plugs,
Two keyboard bounces,
And a glitch on the video screen.



On the ninth day of Christmas, my computer
gave to me
Nine burnt-out fuses,
Eight worthless printouts,
Seven system re-sets,
Six I/O spasms,
Five blank cassettes,
Four garbled Saves,
Three loose plugs,
Two keyboard bounces,
And a glitch on the video screen.



On the tenth day of Christmas, my computer
gave to me
Ten disc-drive lockouts,
Nine burnt-out fuses,
Eight worthless printouts,
Seven system re-sets,
Six I/O spasms,
Five blank cassettes,
Four garbled Saves,
Three loose plugs,
Two keyboard bounces,
And a glitch on the video screen.



On the eleventh day of Christmas, my
computer gave to me
Eleven damaged diskettes,
Ten disc-drive lockouts,
Nine burnt-out fuses,
Eight worthless printouts,
Seven system re-sets,
Six I/O spasms,
Five blank cassettes,
Four garbled Saves,
Three loose plugs,
Two keyboard bounces,
And a glitch on the video screen.



On the twelfth day of
Christmas, my
computer gave to me
Twelve blown-out circuits,
Eleven damaged diskettes,
Ten disc-drive lockouts,
Nine burnt-out fuses,
Eight worthless printouts,
Seven system re-sets,
Six I/O spasms,
Five blank cassettes,
Four garbled Saves,
Three loose plugs,
Two keyboard bounces,
And a glitch on the video screen.



Simple Petpro puts thought into words

Petpro is an uncomplicated word-processing program for the Pet. Although Ian Birnbaum designed it originally for school and college use, it has been applied successfully in a variety of environments.

THIS WORD-processing program has many of the features which are found in larger programs, including right-justification and full editing facilities.

Petpro will run on any large-keyboard Pet. For the 4000 and 8000 series, some small modifications have to be made, and these are mentioned in the text. The program takes up a little over 4K of memory and does not require discs.

The program should be input in lower-case mode so you must Poke 59468,14 before typing it in. For the 4000 and 8000 series

- change the 49 in lines 22, 31 and 48 to 88
- change the 46 in lines 115 and 133 to 85.

Table 1. Design map.

Lines numbers	Function Subroutines
2-29	Subroutines
2-4	Wait for ready — "space" response
5-6	Line printout, editing mode
7	Prints quotation mark and ↑
8	Line wipeout
9	Line-length-exceeded message
10-11	Memory full in editing mode — common routine
12-13	Wait for answer Y/N
14-16	Input-mode option
17	Re-sets line text variables to zero
18-20	Tape input/output
21-22	Tape output
22	File-closing routine
23	Pause
24-25	Memory update in edit mode
26-29	Search for character/ space in justify
30	Delete line
31-42	Initialisation
43-48	Tape Input
50-76	Keyboard Input
50-61	Input checks and conversions
62-63	Character deletion
64-66	Carriage-return deletion with 8000 series, delete line 64
67-70	New-line routine
71-73	Automatic carriage-return routines
74-76	Tab routine
77-111	Editing Mode
80-94	Line-listing and option routines
95-98	Edit
99-102	Insert
103-111	Squeeze
112-139	Output mode and options for continuation
120-124	Justify

With the 8000 series only, line 64 should be deleted.

The program has three specific modes: the input mode, the edit mode and the output mode.

In input mode, text can be input either from the keyboard or from tape. The program allows a variable line-width up to 73 characters. You can set the right-hand margin by making this width smaller. Setting the width at 55 gives a right-hand margin of about 10, assuming that you will later be setting a left-hand margin of 10.

An automatic carriage-return operates no earlier than seven characters before the maximum line width you have set, and no later than two characters after it. It operates as soon as a space is typed, thereby avoiding word breaks. Split words can be amended, if desired, when in edit mode so manual carriage return will rarely have to be used.

Up to 10 tabs are allowed, but if you do not require any type 0. At this stage, if you have chosen tape input, the tape will be read and the program will immediately pass to edit mode.

When inputting from the keyboard, the following points should be noted.

- The Pet keyboard is turned into a normal QWERTY keyboard, so full stops, commas, etc., are in the normal place. The Run/Stop key, and all the cursor-movement keys are disabled — touching them will produce no effect.

- You can delete the last character input by the ↑ key or the Delete/Insert key, whether or not the shift-lock is on. It is best to use ↑ since it can be easily touch-typed. You can delete a carriage return in the same way. You should delete only local mistakes; others can be corrected when editing later.

- To obtain the next pre-set Tab, press —; it will operate whether or not the shift-lock is on. If the last Tab has been passed, or if there are no pre-set Tabs, — will be ignored.

- Automatic carriage-return will not operate until the absolute maximum line length is reached.

There are two ways to enter editing mode. If you fill up the memory, the computer will enter it automatically, though some room will be reserved for manipulation in this mode. After output, you will be able to return to the keyboard and continue.

With large-memory Pets, garbage collection can appreciably slow up some operations in editing mode. It is, therefore, better not to create too much text before editing. The 4000 and 8000 series Pets do not have this problem. The second way to leave the keyboard is by typing a quotation mark — use ↑ for quotation marks otherwise.

In editing mode the keyboard once again acts as a normal Pet keyboard, with

Name	Function
A	Maximum line length
B	1. File number, tape or printer 2. Character count in squeeze
C	Count for number of lines in text
D	1. Flag set to suppress space on new line 2. Controls memory add/subtract 3. Character pointer in justify
E	1. Flag set if last Tab set 2. Set to 2 if memory close to full
F	Flag set if memory full before end of file on tape input
G	Number of lines output to printer for each piece of text
H	Maximum number of lines per page
I	1. General For/Next counter 2. Device number for tape 3. Unshifted ASCII value of A\$
J	1. Secondary address for tape 2. Line number to be edited, etc.
K	1. Counter for line wipe-out 2. Length of next string in squeeze
L	Counter for total number of characters input
M	Maximum number of line possible
N	1. Counter for lines to be printed out during editing mode 2. Length of current string in justify
O	Left-margin length
P	1. Next Tab to be set 2. Length of next string in justify
Q	1. Counter for list of Tabs 2. Length of pause 3. Flag for search in justify
R	1. Counter for pause subroutine 2. Line count in squeeze 3. Flag for character/space found in justify
S	Double-spaced line flag
T	Number of Tabs
U	Set to prevent number of lines output being re-set to zero
V	Set to miss out lines 42-48 when keyboard input follows tape
W	1. Counter for Tab printing 2. Length of current string in squeeze
X	Correct line length pointer
Y	Maximum available memory after null-string pointers set, etc.
Z	Maximum number of lines input prior to editing
T()	List of Tabs pre-set
A\$	1. Character input from keyboard 2. Store for memory full 3. Current string in squeeze 4. Current line in printout
B\$	1. Mode of operation, k/t 2. Store for line number in editing mode 3. Flag for justify
C\$	Last mode of operation
E\$	Next string in squeeze
A\$()	Lines Input from keyboard or tape

Table 2. Variable list

the full stop in the "wrong" place, and cursor movement allowed. Key ↑ will no longer delete characters and the Delete key must be used. Characters may be inserted by using the Insert, shifted Del/Inst, key.

The lines are displayed in groups of 10.

```

1 POKE59468,14:PRINT"Q:PETPRO#2":PRINTSPC(11)"KCOI BIRNBAUM 1981Q":GOTO31
2 PRINT"APRESS <SPACE> WHEN READY."
3 GETA$:IFA$<>" "THEN3
4 RETURN
5 PRINT"Q":FORI=0TO9:IFN+I>0THENRETURN
6 PRINTI:RIGHT$(A$(N+I),LEN(A$(N+I))-1):NEXT:RETURN
7 PRINT"Q":CHR$(34)CHR$(34)CHR$(20)"S"SPC(A+4)"T":POKE623,29:POKE158,1:R
ETURN
8 FORK=32768TO32847:POKEK,32:NEXT:RETURN
9 PRINT"QMAX LINE LENGTH EXCEEDED.":Q=1111:GOSUB23:GOSUB8:RETURN
10 PRINT"QNO "A$" POSSIBLE: MEMORY FULL."
11 Q=2000:GOSUB23:GOTO81
12 GETA$:IFA$<>"Y"ANDB$<>"N"THEN12
13 RETURN
14 PRINT"QKEYBOARD OR TAPE INPUT?"
15 GETB$:IFB$<>"K"ANDB$<>"T"THEN15
16 RETURN
17 FORI=1TOC:A$(I)="" :NEXT:U=1:Y=FRE(0):PRINT"Q":RETURN
18 PRINT"QNAME OF TAPE FILE (IF NO NAME):INPUT"PRESS <RETURN>":A$
19 IFA$=""THENA$=""
20 OPENB,I,J,A$:RETURN
21 B=2:I=F+1:J=1:GOSUB18:FORI=1TOC:PRINT#2,CHR$(34)+A$(I):NEXT
22 CLOSEB:POKE144,49:RETURN
23 FORR=1TOQ:NEXT:RETURN
24 L=L+LEN(A$(N+J))*D:IFL>.7*YORC=MTHENE=2
25 RETURN
26 R=0:D=D+1:IFD>NTHEND=2:IFQ=0THENRETURN
27 IFMID$(A$,D,1)<>" "THENR=1
28 IFR=0THENRETURN
29 GOTO26
30 D=-1:GOSUB24:C=C-1:FORI=N+JTOC:A$(I)=A$(I+1):NEXT:A$(I)="" :RETURN
31 POKE144,49:GOSUB14:C#=B$:PRINT"Q"
32 INPUT"MAX LINE LENGTH (73 OR LESS)":A:IFA>73THENPRINT"Q":GOTO32
33 IFB$="T"THEN42
34 PRINT"QAUTOMATIC CARRIAGE RETURN":PRINT"WILL OCCUR BETWEEN CHARACTER"
35 PRINT"POSITIONS"A-7"AND"A+2
36 INPUT"QHOW MANY TABS (MAX 10)":T:IFT=0THEN41
37 IFT>10THENPRINT"Q":GOTO36
38 PRINT"QENTER THEM IN NUMERICAL ORDER"
39 PRINT"COLUMN POSITIONS ARE BETWEEN 1 AND"A:PRINT:FORI=1TOT
40 PRINT"TAB NO.":I:INPUTT$(I):NEXT
41 IFV=1THEN49
42 M=INT(FRE(0)/A)+10:Z=INT(.9*M):DIMA$(M):Y=FRE(0):IFB$="K"THEN49
43 B=1:I=1:J=0:GOSUB18
44 FORC=1TOZ:INPUT#1,A$(C):L=L+LEN(A$(C))
45 IFST=64THENPRINT"QEND OF FILE":GOSUB22:GOTO78
46 IFL>.7*YTHENGOTO48
47 NEXT:C=C-1
48 F=1:POKE144,49:GOTO77
49 GOSUB2
50 PRINT"Q":POKE167,0:C=1:D=0:E=0:A$(1)=""

```

(listing continued on next page)

Pressing < displays the next 10 lines; pressing > displays the last 10 lines; pressing X allows exit to output mode. Otherwise there are four options:

- Delete a line shown. For example, D7 deletes the line 7 and moves up all the rest. Line 9 becomes the one that would have been first in the next group of 10.
- Edit a line shown. For example, E4 displays line 4 at the top of the screen. Move the cursor to the point where editing is required. Take care not to erase the quotation mark which always precedes the line. When the line is edited to your satisfaction, press Return and the newly-edited line will replace the old one in the displayed group of 10.
- Insert a line before one shown. For example, I3 to insert a line before Line 3. A blank line will appear at the top of the screen, preceded

by the quotation mark. It is essential that this mark is not erased. Type in the new line and press Return when finished.

If the last group of lines is being displayed, it is possible to insert one after the last line. Type I followed by any line number greater than the one shown. For example, if seven lines are displayed, typing I7, I8 or I9 will allow an eighth line to be added. In the event of the last group being exactly 10 lines, a line may be added by first inserting a dummy blank line in the group — e.g., by typing I9 and then Return. This shifts line 10 into the next group, which was previously empty, allowing the real line to be added. The dummy line can then be deleted.

- Squeeze up text to a line. For example, S4 moves text so that each line after, and including line 4, will have at most seven characters less than the maximum allowed per line. The squeeze facility continues to squeeze text until

it meets a blank line or a line beginning with a space, both of which are signals for new paragraphs.

Combining the four editing functions allows a wide range of changes to be made to text. For example, suppose line 4 reads, with a few modifications the program can be used with

and you want to insert the words "very elementary" between "few" and "modifications", while keeping the maximum line length at 55. One way to do this is to type E4, delete all the words after "program" and make the required insertion. Then type I5, and type in the deleted words "can be used with". Finally, by

(continued on next page)

(continued from previous page)

typing S5, all the text will be properly squeezed up.

If you type a wrong letter when choosing an option — e.g., a D instead of an I — you can press Delete to rectify it. Within options E and I, the marker I shows the end of the line. If you exceed the maxi-

mum line length, the computer displays a message and allows you to try again.

After you have seen all the text on the screen you can display it again by typing Y when asked. At this stage you may perform further editing if you wish, and you can make several passes through the text before entering output mode.

If a printer is attached, you can obtain a printout of the text with either single or double-spaced lines. If you have specified a maximum number of lines per page, the printing will stop at the relevant time to allow you to change the paper.

Note that with double-spaced lines, each typed line will take up two lines on the page. So for example, if the paper can take 50 lines you should set the maximum number of typed lines at 25.

When you set the left-hand margin, note that the total line length should not exceed 80.

The program will right-justify the text if required. Justification will be to a width of two more than the maximum line width set. If tables are included, which you do not want to justify, precede each line of the table by at least one space. The program will not justify a line if the next line begins with a space, or is blank. Neither will it justify a line shorter than seven characters less than the maximum line width set.

After printout, a number of options are available: you can print out again; you can save the text on tape; or you can edit the text again, which is useful if you want to change just a few parts and then save again. Any or all of these options can be combined.

You will then have the option of continuing text input, either from the keyboard or from tape. Subsequent printout can either carry straight on from the previous text — in which case the number of lines already output will be remembered — or else you can start on a new page.

In tape input mode, it is possible that the tape may contain more than the available memory can take. In this case, if you want to save the text again on tape, you will need to use the second cassette port. The program is designed to inform you of this, and it will also remind you that there is more text on tape to input.

For non-Pet printers you will need to delete coding which relates to the adding on of a cursor-down symbol for each new line of text. This occurs in line 50, 69, 98 and 111. Most references to LEN(A\$(C)) will have to be reduced by one. These occur on lines 61, 64, and 66. Also subtract 1 from expressions including A in 7, 35, 70, 72, 97, 101, 103, 107, 120 and 122. Change the MID\$ in 110 to Left\$(E\$, B-1); D=2 in 26 to D=1; and 2 in 103 and 120 to 1. Finally the Right\$ function in lines 6, 65, 96 and 109 can be removed. You may need to add code, specific to your printer in order to give you lower-case facilities.

The overriding design philosophy of the program is that it should work as fast as possible, and be as economical as possible with memory space. Unfortunately, this tends to make the readability of the program difficult, but tables 1 and 2 should help if you wish to make modifications.

(listing continued from previous page)

```

51 GETA$: IFA$=" " THEN S1
52 I=ASC(A$) AND 127: IF I=13 THEN 66
53 IF (D=1 AND A$=" ") OR I=30 RI=170 RI=180 RI=29 THEN S1
54 D=0: IF ASC(A$)=34 THEN PRINT "D": GOT078
55 IFA$=" " THEN A$=" "
56 IF I=59 THEN A$=" "
57 IFA$=" " THEN A$=" "
58 IFA$=" " THEN A$=" "
59 IF I=95 THEN 74
60 IF I<>20 AND I<>94 THEN PRINT A$: GOT070
61 IF LEN(A$(C))=1 THEN S3
62 A$(C)=LEFT$(A$(C), LEN(A$(C))-1): PRINT CHR$(20): GOT051
63 A$(C)="": C=C-1: L=L-LEN(A$(C))
64 IF LEN(A$(C))>39 THEN PRINT " " " "
65 PRINT " " " " RIGHT$(A$(C), LEN(A$(C))-1): GOT051
66 IF LEN(A$(C))<39 THEN X=225+PEEK(216): POKE X, (PEEK(X) OR 128)
67 PRINT " " CHR$(13): E=0: L=L+LEN(A$(C))
68 IF C=20 RL: 8*Y THEN PRINT "D": GOT077
69 C=C+1: A$(C)=" " " " : GOT051
70 IF E=0 AND LEN(A$(C))>A-7 AND A$=" " THEN 73
71 A$(C)=A$(C)+A$
72 IF LEN(A$(C))>A+3 THEN S1
73 D=1: GOT067
74 FOR D=1 TO 1: IF PEEK(198)>=TZ(Q)-1 THEN NEXT: GOT051
75 P=TZ(Q)-PEEK(198)-1: FOR N=1 TO P: A$(C)=A$(C)+" ": PRINT " ": NEXT
76 E=(Q-T)*T(C): GOT051
77 PRINT "D" COMPUTER MEMORY FULL, "
78 POKE 167, 1: PRINT "EDIT TEXT IF NECESSARY.": PRINT "P" PRESS "CHR$(34)" WHEN READY
79 GETA$: IFA$<>CHR$(34) THEN 79
80 N=1
81 GOSUB 5: IF I=0 THEN 112
82 PRINT "DELETE EDIT INSERT SQUEEZE + LINE NUMBER":
83 PRINT SPC(10) "OTHERWISE EXIT D S "
84 GETA$: IF A$=" " AND N=10 OR A$=" " THEN N=N+10*(A$=" ") - 10*(A$=" "): GOT081
85 IFA$=" " THEN 112
86 IFA$=" " OR (A$<>"D" AND A$<>"E" AND A$<>"I" AND A$<>"S") THEN 84
87 PRINT A$:
88 GETB$: IF B$=" " THEN 88
89 IF ASC(B$)=20 THEN PRINT B$: GOT084
90 IF ASC(B$)<48 OR ASC(B$)>57 THEN 88
91 PRINT B$: J=VAL(B$): IF J THEN J=I*(A$<>"E")*-1
92 IFA$="D" THEN GOSUB 30: GOT081
93 IFA$="I" THEN 99
94 IFA$="S" THEN 103
95 IF E=2 THEN IF FRE(0)<250 THEN A$="EDITING": GOT010
96 D=-1: GOSUB 24: GOSUB 7: FRINTRIGHT$(A$(N+J), LEN(A$(N+J))-1): INPUT " " : A$
97 GOSUB 8: IF LEN(A$)>A+2 THEN GOSUB 9: GOT096
98 A$(N+J)=" " + A$: D=1: GOSUB 24: GOT081
99 IF E=2 THEN IF FRE(0)<300 OR C=M THEN A$="INSERTING": GOT010
100 FOR I=C TO N+J STEP -1: A$(I+1)=A$(I): NEXT: C=C+1
101 GOSUB 7: INPUT " " : A$: GOSUB 8: IF LEN(A$)>A+2 THEN GOSUB 9: GOT0101
102 GOT098
103 FOR R=N+J TO C-1: A$=A$(R): E$=A$(R+1): W=LEN(A$): K=LEN(E$): IF K<20 OR W=1 THEN 81
104 IF W>A-7 THEN NEXT: GOT081
105 IF MID$(E$, 2, 1)=" " THEN 81
106 IF K<A-6 THEN 109
107 FOR B=A-5-W TO K-1: IF MID$(E$, B, 1)=" " OR B>A+3-W THEN 110
108 NEXT
109 A$(R)=A$+" " + RIGHT$(E$, K-1): J=R+1-N: GOSUB 30: NEXTR: GOT081
110 A$(R)=A$+" " + MID$(E$, 2, B-2): IF MID$(E$, B+1, 1)=" " THEN B=B+1
111 A$(R+1)=" " + RIGHT$(E$, K-E): NEXTR: GOT081
112 PRINT "DO YOU WANT TO LOOK AT THIS TEXT": PRINT "AGAIN?": GOSUB 12
113 IFA$="Y" THEN 80
114 PRINT "IS THERE A PRINTER ATTACHED?": GOSUB 12: IFA$="N" THEN 130
115 PRINT "MAKE SURE THE PRINTER IS ON": GOSUB 2: POKE 144, 46: OPEN 4, 4: IF U=1 THEN 119
116 G=0: PRINT "DO YOU WANT DOUBLE-SPACED LINES?": GOSUB 12: S=(A$="Y")
117 PRINT "MAXIMUM NUMBER OF TYPED LINES PER PAGE": PRINT "(IF NO MAX TYPE 0)":
118 INPUT " " : H: INPUT "LENGTH OF LEFT HAND MARGIN " : I: PRINT #4
119 PRINT "JUSTIFY TEXT?": GOSUB 12: E$=A$: D=1: FOR I=1 TO C: A$=A$(I): IF B$="N" OR I=C THEN
N125
120 N=LEN(A$): P=LEN(A$(I+1)): IF P<1 THEN IF MID$(A$(I+1), 2, 1)<>" " AND N>A-7 THEN 122
121 GOT0125
122 IF N=A+3 THEN 125
123 Q=1: GOSUB 26: Q=0: GOSUB 26: IF D=2 THEN 123
124 A$=LEFT$(A$, D)+" " + MID$(A$, D+1): N=N+1: GOT0122
125 PRINT #4: SPC(D) A$: G=G+1: IFS=-1 THEN PRINT #4
126 IF G<H THEN 128
127 PRINT "MAX LINES PER PAGE REACHED": PRINT "ADJUST PAPER": GOSUB 2: G=0: PRINT "D"
128 NEXT: B=4: GOSUB 22
129 PRINT "PRINT THIS OUT AGAIN?": GOSUB 12: IFA$="Y" THEN 115
130 PRINT "SAVE THIS TEXT ON TAPE?": GOSUB 12: IFA$="Y" THEN GOSUB 21
131 PRINT "EDIT THIS TEXT AGAIN?": GOSUB 12: IFA$="Y" THEN 80
132 E=0: IF F=1 THEN 139
133 PRINT "MORE TEXT TO INPUT?": GOSUB 12: IFA$="N" THEN POKE 144, 46: END
134 PRINT "WILL PRINTOUT CARRY": PRINT "STRAIGHT ON?": GOSUB 12
135 IFA$="N" THEN CLR: GOT031
136 GOSUB 14: IF B$="T" THEN GOSUB 17: GOT043
137 IF C$="K" THEN GOSUB 17: PRINT "O.K. CONTINUE.": Q=555: GOSUB 23: GOT050
138 C$="K": GOSUB 17: V=1: GOT034
139 GOSUB 17: PRINT "THERE IS MORE TEXT ON TAPE TO INPUT": L=0: F=0: GOSUB 2: GOT044

```

sinclair ZX81 PERSONAL COMPUTER

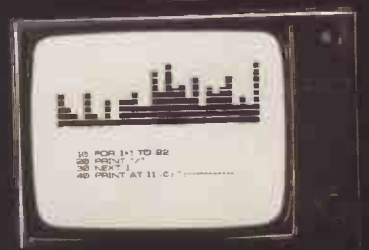

Sinclair ZX81 Personal Computer the heart of a system that grows with you.

1980 saw a genuine breakthrough – the Sinclair ZX80, world's first complete personal computer for under £100. Not surprisingly, over 50,000 were sold.

In March 1981, the Sinclair lead increased dramatically. For just £69.95 the Sinclair ZX81 offers even more advanced facilities at an even lower price. Initially, even we were surprised by the demand – over 50,000 in the first 3 months!

Today, the Sinclair ZX81 is the heart of a computer system. You can add 16-times more memory with the ZX RAM pack. The ZX Printer offers an unbeatable combination of performance and price. And the ZX Software library is growing every day.

Lower price: higher capability

With the ZX81, it's still very simple to teach yourself computing, but the ZX81 packs even greater working capability than the ZX80.

It uses the same micro-processor, but incorporates a new, more powerful 8K BASIC ROM – the 'trained intelligence' of the computer. This chip works in decimals, handles logs and trig, allows you to plot graphs, and builds up animated displays.

And the ZX81 incorporates other operation refinements – the facility to load and save named programs on cassette, for example, and to drive the new ZX Printer.



New **BASIC manual**

Every ZX81 comes with a comprehensive, specially-written manual – a complete course in BASIC programming, from first principles to complex programs.

Kit: £49.⁹⁵

Higher specification, lower price – how's it done?

Quite simply, by design. The ZX80 reduced the chips in a working computer from 40 or so, to 21. The ZX81 reduces the 21 to 4!

The secret lies in a totally new master chip. Designed by Sinclair and custom-built in Britain, this unique chip replaces 18 chips from the ZX80!

New, improved specification

- Z80A micro-processor – new faster version of the famous Z80 chip, widely recognised as the best ever made.
- Unique 'one-touch' key word entry: the ZX81 eliminates a great deal of tiresome typing. Key words (RUN, LIST, PRINT, etc.) have their own single-key entry.
- Unique syntax-check and report codes identify programming errors immediately.
- Full range of mathematical and scientific functions accurate to eight decimal places.
- Graph-drawing and animated-display facilities.
- Multi-dimensional string and numerical arrays.
- Up to 26 FOR/NEXT loops.
- Randomise function – useful for games as well as serious applications.
- Cassette LOAD and SAVE with named programs.
- 1K-byte RAM expandable to 16K bytes with Sinclair RAM pack.
- Able to drive the new Sinclair printer.
- Advanced 4-chip design: micro-processor, ROM, RAM, plus master chip – unique, custom-built chip replacing 18 ZX80 chips.



Built: £69.⁹⁵

Kit or built – it's up to you!

You'll be surprised how easy the ZX81 kit is to build: just four chips to assemble (plus, of course the other discrete components) – a few hours' work with a fine-tipped soldering iron. And you may already have a suitable mains adaptor – 600 mA at 9 V DC nominal unregulated (supplied with built version).

Kit and built versions come complete with all leads to connect to your TV (colour or black and white) and cassette recorder.



ter-



Available now - the ZX Printer for only £49.⁹⁵

Designed exclusively for use with the ZX81 (and ZX80 with 8K BASIC ROM), the printer offers full alphanumeric and highly sophisticated graphics.

A special feature is COPY, which prints out exactly what is on the whole TV screen without the need for further instructions.

At last you can have a hard copy of your program listings – particularly useful when writing or editing programs.

And of course you can print out your results for permanent records or sending to a friend.

Printing speed is 50 characters per second, with 32 characters per line and 9 lines per vertical inch.

The ZX Printer connects to the rear of your computer – using a stackable connector so you can plug in a RAM pack as well. A roll of paper (65 ft long x 4 in wide) is supplied, along with full instructions.

16K-byte RAM pack for massive add-on memory.

Designed as a complete module to fit your Sinclair ZX80 or ZX81, the RAM pack simply plugs into the existing expansion port at the rear of the computer to multiply your data/program storage by 16!

Use it for long and complex programs or as a personal database. Yet it costs as little as half the price of competitive additional memory.

With the RAM pack, you can also run some of the more sophisticated ZX Software – the Business & Household management systems for example.

How to order your ZX81

BY PHONE – Access, Barclaycard or Trustcard holders can call 01-200 0200 for personal attention 24 hours a day, every day.

BY FREEPOST – use the no-stamp-needed coupon below. You can pay

by cheque, postal order, Access, Barclaycard or Trustcard.

EITHER WAY – please allow up to 28 days for delivery. And there's a 14-day money-back option. We want you to be satisfied beyond doubt – and we have no doubt that you will be.

To: Sinclair Research Ltd, FREEPOST 7, Cambridge, CB2 1YY.

Qty	Item	Code	Item price £	Total £
	Sinclair ZX81 Personal Computer kit(s). Price includes ZX81 BASIC manual, excludes mains adaptor.	12	49.95	
	Ready-assembled Sinclair ZX81 Personal Computer(s). Price includes ZX81 BASIC manual and mains adaptor.	11	69.95	
	Mains Adaptor(s) (600 mA at 9 V DC nominal unregulated).	10	8.95	
	16K-BYTE RAM pack.	18	49.95	
	Sinclair ZX Printer.	27	49.95	
	8K BASIC ROM to fit ZX80.	17	19.95	
	Post and Packing.			2.95

Please tick if you require a VAT receipt

TOTAL £ _____

*I enclose a cheque/postal order payable to Sinclair Research Ltd, for £ _____

*Please charge to my Access/Barclaycard/Trustcard account no. _____

*Please delete/complete as applicable. _____

Please print.

Name: Mr/Mrs/Miss _____

Address: _____

FREEPOST – no stamp needed.

PRC12

sinclair ZX81

6 Kings Parade, Cambridge, Cambs., CB2 1SN.
Tel: (0276) 66104 & 21282.

How the ZX81 compares with other personal computers

SYSTEM IDENTIFICATION		ZX81	ZX80	ACORN ATOM	APPLE II PLUS	PET 2001	TRS 80 LEVEL I	TRS 80 LEVEL II
ROM		8K	4K	8K	8K	14K	4K	12K
GUIDE PRICE	Basic unit - inc. VAT Unit plus 16K RAM (*12K RAM)	£70 £120	£100 £150	£175 £285*	£630 £630	£435 £530	£290 £360	£375 £375
COMMANDS	LIST, LOAD, NEW, RUN, SAVE	●	●	●	●	●	●	●
STATEMENTS	PRINT, INPUT, LET, GOTO, GOSUB/RETURN, FOR/NEXT IF/THEN	●	●	●	●	●	●	●
	STEP	●		●	●	●	●	●
	TAB	●			●	●	●	●
ARITHMETIC	ABS, RND	●	●	●	●	●	●	●
FUNCTIONS	INT	●			●	●	●	●
	ATN, COS, EXP, LOG, SGN, SIN, SQR, TAN	●			●	●		●
	ARCSIN, ARCOS	●						
STRING	CHR\$	●	●		●	●		●
FUNCTIONS	LEN	●		●	●	●		●
	ASC(CODE), STR\$, VAL, INKEY\$	●				●		●
NUMBERS	FLOATING PT $\pm 10^{\pm 38}$	●			●	●	●	●
	INTEGERS		●	●	●	●		●
NUMERIC	A-Z			●			●	
VARIABLES	AA-ZØ				●	●		●
	An-Zn, n= any alphanumeric string	●	●					
STRING	A\$ & B\$						●	
VARIABLES	A\$ to Z\$	●	●	●				
	An\$ to Zn\$, n= any alphanumeric character				●	●		●
NUMERIC	SINGLE DIMENSIONAL		●	●			●	
ARRAYS	MULTI DIMENSIONAL	●			●	●		●
DISPLAY	ROWS	24	24	16	24	25	16	16
	COLUMNS	32	32	32	40	40	64	64
	LOW RES GRAPHICS (<7000 pixels)	●	●	●	●	●	●	●
	HI RES GRAPHICS (>40000 pixels)			●	●			
SPECIAL	USR (CALL, LINK)	●	●	●	●	●		●
FEATURES	PEEK, POKE (OR EQUIV)	●	●	●	●	●		●

Sinclair software on cassette.



The unprecedented popularity of the ZX Series of Sinclair Personal Computers has generated a large volume of programs written by users.

Sinclair has undertaken to publish the most elegant of these on pre-recorded cassettes. Each program is carefully vetted for interest and quality, and then grouped with others to form single-subject cassettes.

Software currently available includes games, junior education, and business/household management systems. You'll receive a Sinclair ZX Software catalogue with your ZX81 - or see our separate advertisement in this magazine.

The ultimate course in ZX81 BASIC programming.



Some people prefer to learn their programming from books. For them, the ZX81 BASIC manual is ideal.

But many have expressed a preference to learn *on the machine, through the machine*. Hence the new cassette-based ZX81 Learning Lab.

The package comprises a 160-page manual and 8 cassettes. 20 programs, each demonstrating a particular aspect of ZX81 programming, are spread over 6 of the cassettes. The other two are blank practice cassettes.

Full details with your Sinclair ZX81.

If you own a Sinclair ZX80...



The new 8K BASIC ROM used in the Sinclair ZX81 is available to ZX80 owners as a drop-in replacement chip. (Complete with new keyboard template and operating manual.)

With the exception of animated graphics, all the advanced features of the ZX81 are now available on your ZX80 - including the ability to drive the Sinclair ZX Printer.

sinclair ZX81

6 Kings Parade, Cambridge, Cambs., CB2 1SN.
Tel: (0276) 66104 & 21282.

Upgrading your machine from an uncluttered micro to a versatile word processor will probably teach you as much about the abundance of printers available as about your programming strengths and weaknesses. Tina Billett relates her experiences of the subject and presents the word-processing program she wrote to solve the problems.

Justifying Genie

GENIE has been in our home for a little over a year, during which time we have gone from strength to strength in both range and size of the programs devised, or attempted.

My spouse has written a financial program for our own purposes, which does everything except go to the bank, but I have tended by and large to stick to games and other useless time-wasters. Even so, I have attained a kind of working knowledge as to how this beast called Genie thinks.

One of the carrots dangled in front of me when the subject of home micros first cropped up was that of the word processing potential. It is several years since I last worked in an office, so I had never met one of those contraptions face to face, as it were. My knowledge was limited to what I had seen on TV.

Before the arrival of Genie, I had spent most of my spare time writing, and having got over the initial micro-addiction, I returned my attention to the neglected typewriter, niggling all the while at the unfulfilled promise of the glories of word processing which, I had been informed, would "only be a matter of time".

Eventually we saved enough pennies — or so we thought — to venture into the hitherto unknown world of printers. Confusion piled up on confusion.

Establishing requirements

There were so many available, but so few of those we could afford had what I considered to be a suitable type-face. Editors are peculiar creatures at the best of times, and the thought of presenting a typescript with characters made up of dots to such elevated persons made me shudder.

We perused the pages of appropriate publications endlessly, but the advertised prices, contrary to hopes of miracles, did not diminish with subsequent readings. After much heart searching we decided to try to obtain a second-hand machine, keep our fingers crossed and hope nothing drastic would go wrong — in which case we could have little or no recourse to the vendor.

We tracked down a supplier of re-conditioned Termi-printers and went along to have a look. After trying the poor man's patience to the limit with endless and seemingly stupid questions, we went to have lunch with a promise to think about it. The price was comparable to a new dot-matrix printer, but I had already

made up my mind that however good the latter was professed to be by sales chat, it was not good enough for my purposes. My difficulty was to convince the breadwinner of the family that I could find space for the enormous object I was trying to talk him into purchasing.

Finally I won, and we returned home the proud owners of our first peripheral. The next step was to interface the printer to Genie. We had several choices, but because we want a disc drive eventually, we opted for an expansion box on the grounds that doing it on the cheap would be a false economy.

We had to dig deep into pockets and bank accounts to do this, but reasoned that unless the roof caved in we could probably survive until next pay-day.

After many trials and tribulations we finally had all the necessary hardware, but lacked the software — a word-processing program. As the coffers by now were well and truly empty, I set about writing my own.

To start with I had to decide exactly what my requirements were, balance these against what facilities were available, my programming capabilities, and come up with something both simple and adequate. The resulting effort makes no pretence of being perfect, so the producers of commercial word-processing software need not fear the competition. On the other hand, home micro buffs may find it useful for all manner of things.

There are three major areas of creative writing in which I am engaged — letters, magazine articles, and a weekly newsletter. This program is geared to all three, but hopefully the following notes will enable individuals to select which features to adopt and which to ignore, although a user will be limited if his printer has less than 100 characters per line.

As the words are contained in strings there is a Clear 7500 on line 30, after which the program jumps to options on lines 360 to 400. Elsewhere the listing follows a sequence so there are no sub-routines. There are very few Rems in the listing, contrary to the demands of conventional programs, but this is largely due to preserving memory for more important functions.

The constants N and Y are of prime importance, because the whole program revolves around them. The basic function of the program is to enable the user to compile, then either save or print one page of text, a page being either a single

column of 60 characters or two columns of 45 characters each. This option is determined by the input of Y on line 60 and any deviation from this, either from choice or necessity, must be amended on lines 460, 470, 1460-1480, and 1500.

The number of required lines per page is input on line 50. This can be anything at all so long as it is borne in mind that the double-column option — Y=45 — requires twice the number of lines for a full printed page, and preferably an even number. The value of SS, on lines 480, 1530 and 1540 is also dependent on the size of paper used.

On printers which have a form-feed facility, these could probably be dispensed with altogether. User's address should replace the blurb on lines 1460-1480, and if addressed heading is required then this should be taken into account when determining the value of N. If I have forgotten to mention any other idiosyncrasies of the listing, no doubt you will find out for yourself.

Program features

Lines 80-340. Text input. There are several items worth noting in this section.

Line 130. This is an optional extra for the ex-typist, for the printer bleeps to remind one that the end of the line is looming, enabling insertion of hyphen if the current word is longish. It all depends on how fussy one is on full justification. In any case this can be modified during editing — see instructions for use.

Line 200. For new paragraph. I use the unshifted ESC key, as a matter of convenience, this being in a similar position to the Tab key on my typewriter. Any other key would do the same with modification to this line.

Lines 220-230. The Genie being a peculiar creature, lower-case characters, although not displayed on the VDU, are present as an output to printer.

Unfortunately capitals are unshifted and unless one wishes to hold down the shift key for lower-case throughout, some means has to be found to reverse the normal procedure. These lines do that.

When the required number of lines are complete, no further text is accepted. Only the insertion of * lets the program proceed. The options displayed then are self-explanatory.

Line 460. On the assumption — see note — that the printer is pre-settable for left-hand margin, and that this has been

(continued on page 104)

April 23-25, 1982
Earls Court,
London

Bringing
computers
to life

THE Computer Fair

Personal computers
Home computing
Small business systems

In all walks of life, personal computers have revolutionised computer power — bringing it within the reach of a far wider and more popular market than ever before.

In 1982 this revolution will explode onto the home and personal computer market. To meet this demand, Practical Computing and Your Computer announce a brand new event — The Computer Fair. The promotion of the exhibition will be heavily geared to attract the growing market of potential and existing users of personal computers, from home computer enthusiasts to businessmen.

Bring your computers and services to life — all walks of life — at The Computer Fair!

Complete and return the coupon — we'll send you details.

THE
**Computer
Fair**
Personal computers
Home computing
Small business systems

Exhibition Manager,
THE COMPUTER FAIR,
IPC Exhibitions Ltd.,
1, Throwley Way,
Sutton, Surrey, SM1 4QQ

Name _____
Position in Company _____
Company _____
Address _____
Tel. No. _____

● Circle No. 159

```

10 CLS: PRINT@338,"WORD PROCESSING PROGRAMME
"
15 REM (C) T. BILLET 1981
20 PRINT@470,"BY TINA BILLET": PRINT : PRIN
T : PRINT
30 CLEAR 7500: GOTO 360
50 CLS: INPUT "HOW MANY LINES PER PAGE"; N
60 INPUT "HOW MANY CHARACTERS PER LINE"; Y
70 DIM A$(N+1),B$(N+1)
80 PRINT "READY TO START"
90 PRINT CHR$(14);
100 X=X+1: IF X=N+1 THEN 350
110 A$(X)=" "
120 I$=INKEY$: IF I$="" THEN 120
130 IF LEN(A$(X))=Y-7 THEN LPRINT CHR$(7)
140 IF I$=CHR$(8) AND LEN(A$(X))>0 THEN A$(X
)=LEFT$(A$(X),LEN(A$(X))-1): PRINT I$: GOTO
260
150 IF I$=CHR$(8) THEN I$="": GOTO 120
160 IF I$=CHR$(13) THEN PRINT I$: GOTO 100
170 IF I$=CHR$(44) THEN I$=","
180 IF I$=CHR$(45) THEN I$="-"
200 IF I$=CHR$(91) THEN I$=" " : PRINT I$
: A$(X)=I$: GOTO 120
220 T=ASC(I$): IF T>64 AND T<91 THEN I$=CHR$(
T+32): GOTO 240
230 IF T>96 AND T<123 THEN I$=CHR$(T-32)
240 PRINT I$:
250 A$(X)=A$(X)+I$
260 IF LEN(A$(X))<Y+1 THEN 120
270 IF LEN(A$(X))=Y+1 AND RIGHT$(A$(X),1)="
" THEN PRINT : GOTO 100
280 J=1
290 IF MID$(A$(X),(LEN(A$(X))-J),1)<>" " THE
N J=J+1: GOTO 290
300 B$=RIGHT$(A$(X),J): A$(X)=LEFT$(A$(X),(L
EN(A$(X))-J)
310 FOR I=1 TO J: PRINT CHR$(8): : NEXT
320 IF LEFT$(B$,1)=" " THEN B$=RIGHT$(B$, (LE
N(B$)-1))
330 PRINT : PRINT B$:
340 X=X+1: IF X=N+1 THEN 350:ELSEA$(X)=B$: B
$="": GOTO 120
350 PRINT : PRINT : PRINT N: " LINES COMPLET
E. " : PRINT
360 PRINT : PRINT "PRESS * TO CONTINUE":
370 M$=INKEY$: IF M$<>"*" THEN 370
380 CLS: D=0: PRINT "OPTIONS": PRINT : PRINT
"1 - OUT TO PRINTER": PRINT "2 - REVIEW LIN
ES": PRINT "3 - NEW PAGE": PRINT "4 - STOP":
PRINT "5 - EDIT": PRINT "6 - JUSTIFY"
385 PRINT "7 - SAVE DATA TO TAPE": PRINT "8
- INPUT DATA FROM TAPE": PRINT: PRINT "ENTER
CHOICE": INPUT D
390 ON D GOTO 460, 410, 440, 450, 570, 910,
1640, 1880
400 GOTO 380
410 FOR Q=1 TO N: PRINT Q: A$(Q)
420 NEXTQ
430 GOTO 360
440 IF A$(1)<>" " THEN INPUT "ARE YOU SURE":
S$
442 IF LEFT$(S$,1)="N" THEN 380
444 RUN 50
450 END
460 IF Y=45 THEN FOR Q=1 TO N/2: LPRINT A$(Q
): : SP=Y-LEN(A$(Q))+10: FOR A=1 TO SP: LPRIN
T CHR$(32): : NEXTA: LPRINT A$(Q+N/2): NEXT
Q
470 IF Y>45 THEN 1420
480 SS=67-(N/2): FOR P=1 TO SS: LPRINT : NEX
T
490 IF C=0 THEN 530
500 B=B+1
510 IF B<C THEN 460
520 IF B=C THEN C=0: B=0: GOTO 380
530 INPUT "DO YOU WANT MORE COPIES": V$
540 IF LEFT$(V$,1)<>"Y" THEN 380
550 INPUT "HOW MANY": C
560 GOTO 460
570 INPUT "EDIT - WHICH LINE - ENTER NUMBER"
: D
575 IF D>N THEN 570
580 A$=A$(D): P=1
590 PRINT CHR$(14);
600 K1$=INKEY$: IF K1$="" THEN 600
610 IF K1$=CHR$(8) AND P>1 THEN PRINT K1$:
: P=P-1: K1$="": GOTO 600
620 IF K1$=CHR$(8) THEN K1$="": GOTO 600
630 IF K1$=" "PRINT MID$(A$,P,1): : P=P+1: G
OTO 600
640 IF K1$<>CHR$(13) THEN 670
650 IF P>LEN(A$) THEN PRINT K1$: A$(D)=A$:
A$="": GOTO 360
660 IF P>1 THEN PRINT RIGHT$(A$,((LEN(A$)-P
)+1)): A$(D)=A$: A$="": GOTO 360:ELSEIF P=1 T
HEN PRINT A$: A$(D)=A$: A$="": GOTO 360
670 IF K1$<>"D" THEN 710
680 IF P=1 THEN A$=RIGHT$(A$, (LEN(A$)-1)): G
OTO 600
690 IF P>LEN(A$) THEN A$=LEFT$(A$, (LEN(A$)-
1)): GOTO 600
700 F$=LEFT$(A$,P-1)+RIGHT$(A$,LEN(A$)-P): A
$=F$: GOTO 600
710 IF K1$<>"I" THEN 820
720 TP$=INKEY$: IF TP$="" THEN 720
730 IF TP$=CHR$(27) THEN 600
740 IF TP$=CHR$(13) THEN TP$="": GOTO 720
750 IF TP$=CHR$(8) AND P>1 THEN P=P-1: PRINT
: TP$: F$=LEFT$(A$,P-1)+RIGHT$(A$, (LEN(A$)-P
)): A$=F$: F$="": GOTO 720
760 IF TP$=CHR$(8) THEN 720
770 T=ASC(TP$): IF T>64 AND T<91 THEN TP$=CH
R$(T+32): GOTO 790
780 IF T>95 AND T<123 THEN TP$=CHR$(T-32)
790 IF P=1 THEN F$=TP$+A$: P=P+1: PRINT TP$:
: TP$="": A$=F$: F$="": GOTO 720
800 IF P>LEN(A$) THEN F$=A$+TP$: P=P+1: PRI
NT TP$: : TP$="": A$=F$: F$="": GOTO 720
810 F$=LEFT$(A$,P-1)+TP$+RIGHT$(A$,LEN(A$)-P
+1): P=P+1: PRINT TP$: : TP$="": A$=F$: F$="
": GOTO 720
820 IF K1$<>"C" THEN 600
830 TP$=INKEY$: IF TP$="" THEN 830
840 T=ASC(TP$): IF T>64 AND T<91 THEN TP$=CH
R$(T+32): GOTO 860
850 IF T>95 AND T<123 THEN TP$=CHR$(T-32)
860 IF P=1 THEN F$=TP$+RIGHT$(A$, (LEN(A$)-1
)): A$=F$: GOTO 890
870 IF P=LEN(A$) THEN F$=LEFT$(A$, (LEN(A$)-1
))+TP$: A$=F$: GOTO 890
880 A$=LEFT$(A$,P-1)+TP$+RIGHT$(A$,LEN(A$)-P
)
890 PRINT TP$: : P=P+1: TP$="": GOTO 600
900 GOTO 600
910 FOR Q=1 TO N
920 L$=INKEY$: IF L$="*" THEN 360
930 IF A$(Q)=" " THEN 1380
940 IF LEFT$(A$(Q),5)=" " THEN 960
950 IF LEFT$(A$(Q),1)=" " THEN A$(Q)=RIGHT$(
A$(Q),(LEN(A$(Q))-1)): GOTO 950
960 IF RIGHT$(A$(Q),1)=" " THEN A$(Q)=LEFT$(
A$(Q),(LEN(A$(Q))-1)): GOTO 960
970 IF LEN(A$(Q))=Y THEN PRINT Q: A$(Q): NEX
T: GOTO 360
980 IF LEN(A$(Q))<Y THEN 1120
990 IF LEFT$(A$(Q),5)=" " THEN S=6: V=0:
GOTO 1010
1000 S=1: V=0
1010 IF MID$(A$(Q),S,2)=" " THEN V=V+1
1020 IF V=1 THEN A$(Q)=LEFT$(A$(Q),S-1)+RIGH
T$(A$(Q),(LEN(A$(Q))-S)): GOTO 970

```

(continued on next page)

(listing continued from previous page)

```

1030 S=S+1: IF S>LEN(A$(Q)) THEN 1050
1040 GOTO 1010
1050 J=1
1060 IF MID$(A$(Q), (LEN(A$(Q))-J), 1) <> " " TH
EN J=J+1: GOTO 1060
1070 F$=LEFT$(A$(Q), (LEN(A$(Q))-J))
1080 B$=RIGHT$(A$(Q), J): A$(Q)=F$: F$=""
1090 IF Q=N THEN B$="" : GOTO 930
1100 IF LEFT$(A$(Q+1), 1) = " " THEN 1330
1110 A$(Q+1)=B$+" "+A$(Q+1): GOTO 930
1120 IF Q=N THEN 1210
1130 IF LEFT$(A$(X), 5) = " " THEN J=6: GOT
O 1150
1140 J=1
1150 IF MID$(A$(Q+1), J, 1) <> " " THEN J=J+1: I
F J<LEN(A$(Q+1)) THEN 1150
1160 IF J>LEN(A$(Q)) THEN 1210
1170 IF LEFT$(A$(Q+1), 5) = " " THEN PRINT
Q: A$(Q): NEXT: GOTO 360
1180 IF A$(Q+1) = "" THEN PRINT Q: A$(Q): NEXT
: GOTO 360
1190 B$=LEFT$(A$(Q+1), J): F$=A$(Q)+" "+B$: G
$=RIGHT$(A$(Q+1), (LEN(A$(Q+1))-J)): A$(Q)=F$
: A$(Q+1)=G$: F$="" : G$=""
1200 GOTO 930
1210 S=1: V=0
1220 IF MID$(A$(Q), S, 1) <> " " AND MID$(A$(Q),
S+1, 1) = " " AND MID$(A$(Q), S+2, 1) <> " " THEN V
=V+1
1230 IF S<LEN(A$(Q)) THEN S=S+1: GOTO 1220
1240 IF V=0 THEN PRINT Q: A$(Q): NEXT: GOTO
360
1250 IF V<(Y-LEN(A$(Q))) THEN PRINT Q: A$(Q)
: NEXT: GOTO 360
1260 IF LEFT$(A$(Q), 2) = " " THEN S=6: GOTO 1
280
1270 S=1
1280 IF MID$(A$(Q), S, 1) <> " " THEN S=S+1: GOT
O 1280
1290 IF MID$(A$(Q), S, 1) = " " AND MID$(A$(Q), (
S+1), 1) <> " " THEN TP$=" ": F$=LEFT$(A$(Q), S)
+TP$+RIGHT$(A$(Q), (LEN(A$(Q))-S)): A$(Q)=F$
: F$=""
1300 IF LEN(A$(Q))=Y THEN PRINT Q: A$(Q): NE
XT: GOTO 360
1310 S=S+2: GOTO 1280
1320 GOTO 360
1330 K=Q+2: FOR M=K TO N: B$(M)=A$(M-1) : NEX
T
1340 A$(Q+1)=B$
1350 FOR M=K TO N: A$(M)=B$(M): B$(M)="" : NE
XT
1360 A$(N+1)="" : B$=""
1370 GOTO 930
1380 K=Q: FOR M=K TO N: B$(M)=A$(M+1): NEXT
1390 FOR M=K TO N: A$(M)=B$(M): B$(M)="" : NE
XT
1400 IF Q=N THEN PRINT Q: A$(Q): GOTO 360
1410 GOTO 930
1420 INPUT "DO YOU WANT ADDRESSED HEADINGS":
X$
1430 IF LEFT$(X$, 1) <> "Y" THEN G=1: GOTO 1520
1440 INPUT "DATE": D$
1450 G=2
1460 LPRINT TAB(40); "999, ANYSTREET"
1470 LPRINT TAB(40); "ANY TOWN"
1480 LPRINT TAB(40); "ANY COUNTY"
1490 LPRINT
1500 LPRINT TAB(40); D$
1510 FOR E=1 TO 3: LPRINT : NEXT
1520 FOR Z=1 TO N: LPRINT A$(Z): NEXT
1530 IF G=1 THEN SS=67-N
1540 IF G=2 THEN SS=67-(N+8)
1550 FOR P=1 TO SS: LPRINT : NEXT
1560 IF C=0 THEN 1600
1570 B=B+1
1580 IF B=C THEN C=0: B=0: G=0: GOTO 380
1590 IF B<C THEN 1630
1600 INPUT "DO YOU WANT COPIES": X$
1610 IF LEFT$(X$, 1) <> "Y" THEN C=0: B=0: G=0
: GOTO 380
1620 INPUT "HOW MANY": C
1630 ON GOTO 1520, 1660
1640 INPUT "TITLE": T$
1670 INPUT "DATE": D$
1680 INPUT "SUBJECT": S$
1690 INPUT "OUTPUT TAPE READY": Z$
1700 FOR X=1 TO N: IF LEFT$(A$(X), 5) = " "
THEN A$(X)="" : "+RIGHT$(A$(X), LEN(A$(X))
-5)
1730 J=1
1740 IF MID$(A$(X), J, 1) = " " THEN A$(X)=LEFT$
(A$(X), J-1)+CHR$(191)+RIGHT$(A$(X), LEN(A$(X)
)-J)
1742 IF MID$(A$(X), J, 1) = " " THEN A$(X)=LEFT
$(A$(X), J-1)+CHR$(140)+RIGHT$(A$(X), LEN(A$(X)
)-J)
1744 IF MID$(A$(X), J, 1) = " " THEN A$(X)=LEFT
$(A$(X), J-1)+CHR$(162)+RIGHT$(A$(X), LEN(A$(X)
)-J)
1750 IF MID$(A$(X), J, 1) = CHR$(34) THEN A$(X)=
LEFT$(A$(X), J-1)+CHR$(188)+RIGHT$(A$(X), LEN(
A$(X))-J)
1760 IF J=LEN(A$(X)) THEN 1775
1770 J=J+1: GOTO 1740
1775 PRINT X: A$(X)
1780 NEXT
1790 PRINT "-1, N, T$, D$, S$, Y
1800 D1=INT(N/4): D2=N-D1+4
1810 FOR R=1 TO D1: PRINT "-1, A$(R), A$(R+D1)
, A$(R+(D1*2)), A$(R+(D1*3)) : NEXT
1820 DD=D1+4: IF DD=N THEN 2000: ELSE DD=N-DD
1830 IF D3=1 THEN PRINT "-1, A$(DD+1)
1840 IF D3=2 THEN PRINT "-1, A$(DD+1), A$(DD+2)
)
1850 IF D3=3 THEN PRINT "-1, A$(DD+1), A$(DD+2)
, A$(DD+3)
1860 GOTO 2000
1880 INPUT "INPUT TAPE READY": V$
1890 INPUT "-1, N, T$, D$, S$, Y
1900 PRINT "TITLE": T$: PRINT D$: PRINT "SU
BJECT": S$: PRINT "PRINT N, " LINES " , Y
: " CHARS PER LINE": PRINT
1910 INPUT "CONTINUE": Y$
1920 IF LEFT$(Y$, 1) <> "Y" THEN 380
1930 DIM A$(N+1), B$(N+1)
1940 D1=INT(N/4): D2=N-D1+4
1950 FOR R=1 TO D1: INPUT "-1, A$(R), A$(R+D1)
, A$(R+(D1*2)), A$(R+(D1*3)) : NEXT
1960 DD=D1+4: IF DD=N THEN 2000: ELSE DD=N-DD
1970 IF D3=1 THEN INPUT "-1, A$(DD+1)
1980 IF D3=2 THEN INPUT "-1, A$(DD+1), A$(DD+2)
)
1990 IF D3=3 THEN INPUT "-1, A$(DD+1), A$(DD+2)
, A$(DD+3)
2000 FOR X=1 TO N: IF LEFT$(A$(X), 5) = " "
THEN A$(X)="" : "+RIGHT$(A$(X), LEN(A$(X))
-5)
2030 J=1
2040 IF MID$(A$(X), J, 1) = CHR$(191) THEN A$(X)
=LEFT$(A$(X), J-1)+" "+RIGHT$(A$(X), LEN(A$(X)
)-J)
2042 IF MID$(A$(X), J, 1) = CHR$(140) THEN A$(X)
=LEFT$(A$(X), J-1)+CHR$(58)+RIGHT$(A$(X), LEN(
A$(X))-J)
2044 IF MID$(A$(X), J, 1) = CHR$(162) THEN A$(X)
=LEFT$(A$(X), J-1)+CHR$(59)+RIGHT$(A$(X), LEN(
A$(X))-J)
2050 IF MID$(A$(X), J, 1) = CHR$(188) THEN A$(X)
=LEFT$(A$(X), J-1)+CHR$(34)+RIGHT$(A$(X), LEN(
A$(X))-J)
2060 IF J=LEN(A$(X)) THEN 2075
2070 J=J+1: GOTO 2040
2075 PRINT X: A$(X)
2080 NEXT
2090 GOTO 380

```

(continued from page 101)

done, then two columns of text are printed from top to bottom of page.

Lines 480-560. Any number of copies obtainable.

Lines 570-900. Editing text. For further details, see Instructions for use.

Lines 910-1410. Justification — ditto.

Lines 1420-1630. Print out, and copy for 60 characters per line, single column — letters or straight text.

Lines 1660-1860. Saving text to tape. This procedure is a trifle long-winded as paragraph indents, commas and quotation marks have to be replaced by other symbols in order to be correctly recorded as data. After recording, the procedure is reversed to enable further editing, printing, etc.

Lines 1880-2090. Input previously-recorded data from tape. Again this takes time, not only the actual input, but also reversing symbols back into intelligible text.

Instructions for use. This program makes no pretence of being perfect, yet with the observance of a few simple rules no great problems should arise, and even if they do, all is not lost. By the simple process of pressing Break and entering

GOTO 380

the program can be re-entered without loss of text.

Let us assume that the user has correctly keyed in the program. When offered Options, enter 3 — for new page.

Answer the questions concerning lines and characters per line in accordance with desire — and hopefully accurate modifications. If all is well, Ready To Start and cursor will appear.

All usual characters are permitted, including the back-space. If everything grinds to a halt towards the end of the line, check that the expansion-box/printer is plugged in and switched on unless, of course line 130 has been omitted, in which case you are on your own.

But how do you know in advance how many lines you are going to need? Set the number of lines to the maximum for the page size. When the text is complete, press Break enter GOTO 380, select 2, Review Lines, and the text will rapidly scroll up the VDU. Have your fingers poised over Shift and @. The line, \$ number will be displayed at the left-hand side. Note the number of the last line of text, press Break, and enter

N= (number of lines), GOTO 380.

Editing. The facilities for editing text may not be comparable to other word processing programs, but I find them adequate. I have tried to make the commands compatible with the Genie's program editing commands. D will delete one character; C will change one character; I enables the user to insert as many characters as required up to a total of 250 which is the maximum string length.

To escape from insert mode, use shifted ESC as usual — New Line will not work.

Make sure you allow time for each inserted character to be digested, and hold shifted ESC for at least three seconds, or peculiar things may happen. Also try not to back-space during insert mode. Re-Edit lines if necessary. A line may be deleted completely by

Break A\$(Line No) = "" : GOTO 380.

Justify. As this is rather slow, I find that I can read the text easily, and if editing is necessary simply press Shift and *, hold and wait. At a convenient time Press *. To Continue will appear. Again, the line number is displayed. This should be noted for editing purposes.

Depending on how important the communication is, full justification is possible where the first word of the next line is too long to be moved up, by inserting a hyphen at an appropriate position during initial input. This will automatically justify all lines. Where extensive editing has taken place some adjustment may be necessary. If at any time an FC Error occurs, enter Goto 380; then review lines, and make whatever adjustment is necessary.

The program is relatively simple and should be easily modified to suit most needs.

Note. I believe that the facility for setting left-hand margins is the exception rather than the rule. In this case lines 460 and 1520 could be modified to read
PRINT TAB (n); etc.
n being the required margin.

5¹/₄" WINCHESTERS

- * Complete Systems Available
- * Sub-Systems for S100 computers
- * Sub-Systems for Z80 computers
- * Fast Drives with Buffered Seeks
- * Versatile Controller

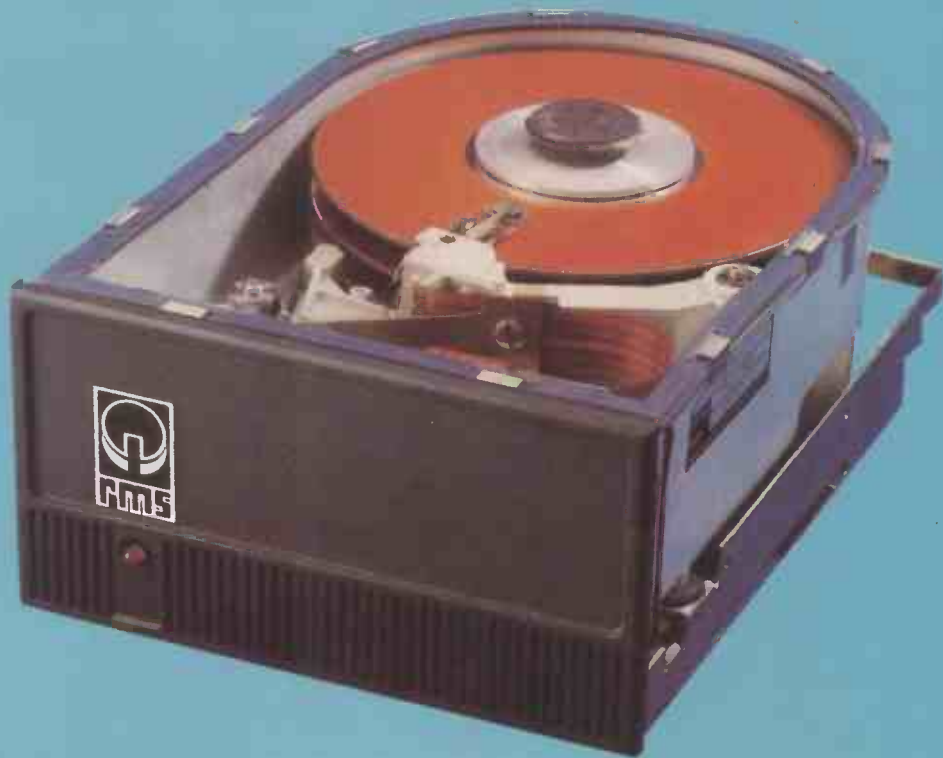

Drives Available NOW!

The long-awaited 5.25" Winchester drives are available now from Hotel Microsystems. The greatly improved speed and storage capacity made available by the mini-Winchesters now make feasible many applications, for which floppy drives were too small, too unreliable or too slow. Drives of different capacities ranging from 2.5Mb to 12Mb are available. All the drives we supply have their own microprocessor and are thus able to provide buffered seeking resulting in vastly improved performance.

Versatile Controller

The XCOMP Winchester controller is a custom designed microprogrammable controller which consists of two printed circuit boards. It has buffered seeking capabilities and is upwards compatible to higher capacity drives.

Complete Systems

The North Star Horizon microcomputer is now available incorporating any of the mini-Winchester drives featured above.

S100 Sub-Systems

An upgrade kit for users of S100 microcomputers contains all the hardware required to add a Winchester in place of a mini-floppy drive. The XCOMP ST/S S100 controller is included together with an S100 card which provides the necessary power supplies to connect to the Winchester. Fitting to the microcomputer is straightforward — no soldering is required and the Winchester is housed in the same place as the floppy drive it replaces. Horizon users have a choice of software; either the high-performance HMSOS single/multi-user operating system or CP/M.

Z80 Sub-Systems

The sub-system for Z80-based microcomputers consists of a packaged drive and controller with power supply. The controller is the XCOMP ST/R custom designed microprogrammable controller. The two printed circuit boards are connected via a 50-way ribbon cable to an interface board which plugs into the Z80 socket in your microcomputer. The sub-system is housed in an alloy cabinet with a power supply. Source listings of CP/M drivers are available.

Sub-Systems are also available for APPLE and PET

Hotel Microsystems Limited

69 Loudoun Road London NW8 0DQ Telephone 01-328 8737/8 Telex 266828 H M S-G

The Consummate Compact Computer.



You'll love the Black Box 3/30. It's everything you've ever wanted in a desktop computer. Including a very attractive price tag.

Take a look inside its modest enclosure. And you'll find an advanced 5-Mbyte micro-Winchester for fast-access, high-capacity storage. Plus a dual-sided, double-density floppy for backup.

The Black Box 3/30 gives you the ultimate in memory management and I/O flexibility. You can expand from 64k right up to 1/2-Mbyte of addressable RAM. And there are 16 programmable I/O ports along with an IEEE 488 bus that support VDUs, printers, other peripherals — and datacomm.

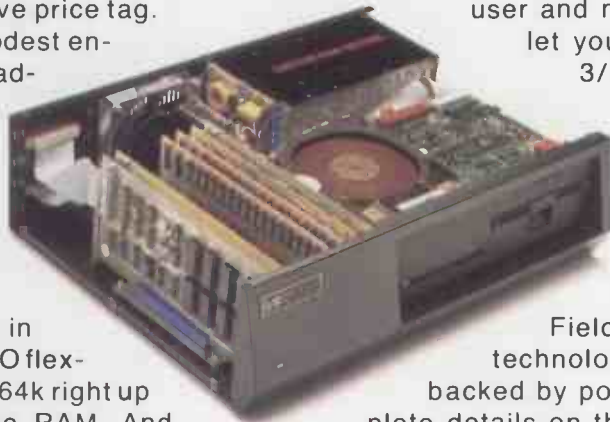

When it comes to software support, there's simply none better. Our single-user, multi-user and network operating systems let you configure the Black Box 3/30 to meet the widest range of tasks. For applications and development, you have a choice of BASIC, PL/1, PASCAL, FORTRAN, and COBOL languages.

The Black Box 3/30. Field-proven microcomputer technology perfectly packaged. And backed by powerful software. For complete details on the Black Box 3/30, call or write the RAIR dealer nearest you. Be sure to ask about the RAIR Rental Plan with purchase option.

UK Black Box Dealers

- T & V Johnson (Microcomputers) Ltd** Steve Johnson, Johnson House, 75-79 Park Street, **Gamberley**, Surrey Tel: 0276 20446 **also** Howard Johnson, 48 Gloucester Road, **Bristol** Tel: 0272 422061 **and** Ian Kitching, 148 Cowley Road, **Oxford** Tel: 0865 721461
- Holdene Ltd**—Manuel Comarcho, Microcomputer Systems, Manchester Unity House, 11-12 Rampart Street, **Leeds** LS6 2NU Tel: 0532 459459
- Arden Data Processing** John Wright, 44-46 Bridge Street, **Peterborough** PE1 1DH Tel: 0733 49577 **and** David Hollis, Municipal Buildings, Charles Street, **Leicester** Tel: 0533 22255
- Healey Office Equipment Ltd** Alby Healey, Unit 7 Westfield Industrial Estate, Portsmouth Road, **Horndean**, Hants Tel: 0705 597555
- GMS Computing Ltd** Ken Jones, Smithfield House, Blonk Street, **Sheffield** S1 5BU Tel: 0742 730191
- Rockmain Ltd** Vincent Spain, Anzeec House, 6 Stour Street, **Canterbury** CT1 2NR Tel: 0227 61218 **and** Dan Reid, 21 Bloomsbury Way, **London** WC1A 2TH Tel: 01-404 5958
- Lion Microcomputers Ltd** Andrew Margolis, 227 Tottenham Court Road, **London** W1P 0HX Tel: 01-637 1601
- NSC Computer Shop Ltd** Adam Wiseberg, 29 Hanging Ditch, **Manchester** ME4 3ES Tel: 061 832 2269
- Digitus Limited** Suren Patel, 9 Macklin Street, **London** WC2 Tel: 01-405 6761
- Omega Electric Ltd** Flaxley Mill, Flaxley Road, **Mitcheldene** Gloucestershire Tel: 0452 76532
- Bell Business Services** 8th Floor, Unicentre, **Preston**, Lancashire Tel: 0772 600813
- Rair Limited**, 6-9 Upper St. Martin's Lane, **London** WC2H 9EQ Tel: 01-836 6921

RAIR

Commodore VIC-20

A fully-fledged, fully expandable, computer with large typewriter-style keyboard, programmable function keys, PET compatible. Gives 24 colours and sound, (to the degree that it can be used to compose music). High resolution graphics module available as extra. Speaks BASIC. Easy-to-use, even for beginners. New VIC-20 material is available and more is on the way. Supplied with easy-to-read, easy-to-use manual, suitable for beginners and children. Programs can be stored on optional VIC tape recorder. **Commodore approved supplier.**

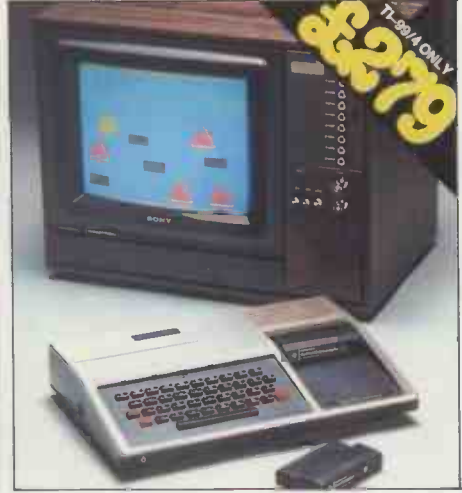
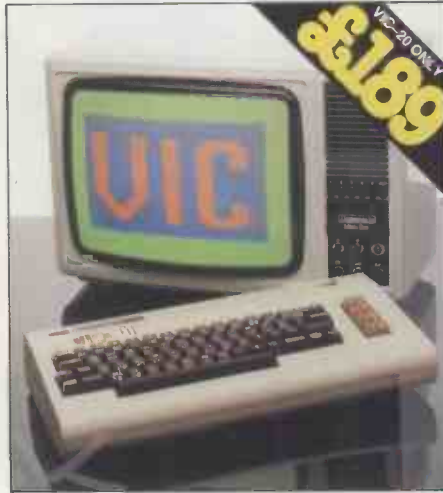

Texas Instruments TI-99/4 (PAL colour TV compatible)

Usable literally within minutes of unpacking. Anyone can use it without previous computer experience or programming knowledge. Powerful 16K. BASIC language. Special features: high resolution graphics let you create animated displays, charts, graphs; built-in music synthesizer allows you to build notes and chords; equation calculator for maths solutions. Designed for home management, educational and entertainment use. Large amount of educational software available on modules for youngsters. Programs can also be stored using good quality tape recorder. **Texas Instruments approved supplier.**

Trust the unique Computer Supermarket to be first with the unique new personal computers.

Four new-technology computers bring you colour, sound, high resolution graphics. All with plug-in program modules. All at unique Computer Supermarket prices.

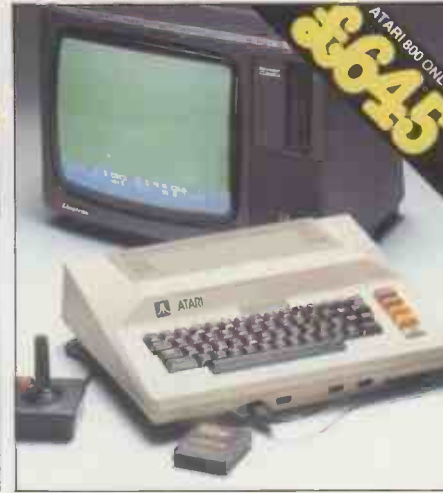

Atari 400

Brings the family music, art, education, entertainment. A general purpose personal computer that's easy to operate and offers 16 colours, each with 8 intensities; high resolution graphics; 4 sound synthesizers; 57 key alphanumeric keyboard with upper/lower case, inverse video, full screen editing, four-way cursor control, 29 graphics keys. Programming languages: BASIC, ASSEMBLER, PILOT. Programs can be stored on optional Atari tape recorder. **Atari approved supplier.**

Atari 800

Top-of-the-line personal computer. Advanced peripheral components, comprehensive software library. Modular design precludes obsolescence. 16 colours (8 intensities), 4 sound synthesizers; 57 keys with upper/lower case, inverse video, full screen editing, four-way cursor control, 29 graphics keys. Programming languages: BASIC, EXTENDED BASIC, ASSEMBLER, PILOT, PASCAL. Programs can be stored on optional Atari tape recorder. **Atari approved supplier.**

THESE EXCITING NEW PERSONAL COMPUTERS CONNECT TO VIRTUALLY ANY COLOUR OR MONO TV. Full range of peripherals will be available for each computer. All units are complete and ready to use. 13 amp plug fitted. Thorn colour TV's can be supplied for use with these computers. Details on application.

Prices include VAT. P&p & insurance £3.50

Your remittance should be made payable to 'Computer Supermarket Ltd', and shall remain your money until the goods have been despatched to you at the address specified. All goods offered are subject to Computer Supermarket conditions of sale, copies available on request. Registered in England No. 2646589.

PRESTEL SERVICE Prestel subscribers can obtain further details on these computers - and place orders for them - through the Prestel service. **PRESTEL No. 400400**

To Computer Supermarket Ltd, Douglas House, Queens Square, Corby, Northants.

I enclose my cheque for £ _____

Please send me

- Commodore VIC-20 at £192.50
- Texas Instruments TI-99/4 at £282.50
- Atari 400 at £348.50
- Atari 800 at £648.50
- Hardware/Software list
- Atari tape recorder at £45 inc. VAT, p&p
- VIC tape recorder at £40 inc. VAT, p&p

Or debit my Access/Barclaycard/Diners Card No.

Signature _____

Name _____

Address _____

(BLOCK CAPITALS PLEASE) PC/D

COMPUTER SUPERMARKET

COMPUTER SUPERMARKET LTD, DOUGLAS HOUSE, QUEENS SQUARE, CORBY, NORTHANTS. TELEPHONE 05366 61587/8 AND 62571



*Double Anniversary
for The Perfect Couple*

megastor
and
apple*

1st Anniversary

of the first
MEGASTOR
installation
AUGUST 1980



2nd Anniversary

of the first installation of
Vlasak's specially-written
Apple business-
software
AUGUST 1979



MEGASTOR consists of two very reliable 8-inch BASF drives, an integral power supply, and a controller card for Apple II.

In addition, we are able to offer a range of specially-developed user software – inventory, accounting, payroll, etc – to utilise MEGASTOR's large storage capacity.

Special software is available to convert Apple II DOS files to IBM 3741-formatted EBCDIC-encoded files, and to read IBM-formatted files.

MEGASTOR offers the user 1.1 or 2.2 Megabytes of storage power per dual-drive unit.

SOME OFTEN-ASKED QUESTIONS

Q: What drives?

A: BASF double-sided, double-density 8" drives.

Q: How do I copy programs from 5¼" to 8" disks?

A: A utilities disk that provides a direct copy program for DOS 3.2 is supplied. DOS 3.3 files are transferred using FID (on the Apple System Master Disk). Pascal programs can be copied by using the Pascal Autoboot utility (£75).

Q: Is MEGASTOR any faster than 5¼" disks?

A: Yes. A program will operate faster on MEGASTOR than on mini-disks.

Q: Can I run mini-disks and MEGASTOR together?

A: Yes. The MEGASTOR can be used stand-alone, or in combination with mini-disk drives.

MEGASTOR software available from VLASAK:

LEDGERS: fully-integrated, 1500 accounts, 6000 transactions/month, Open-Item, or Balance-Brought-Forward.

INVOICING: User-configured to produce invoices, credit notes, delivery notes, and picking notes. Automatically updates the Sales Ledger.

STOCK CONTROL (INVENTORY): 3000 to 6000 stock records on-line, with an average access time of 1 second.

PAYROLL: 400 employees (200 weekly, 200 monthly). All tax & NI contribution codes supported. 12 pre-tax payments, and 5 post-tax adjustments available.

**Vlasak
Computer
Systems**



Vlasak House, Stuart Road, High Wycombe, Bucks HP13 6AG
Telephone: High Wycombe (0494) 448633

DISTRIBUTORSHIP AND OVERSEAS ENQUIRIES WELCOMED

* Apple is a trade mark of Apple Computer Inc.

Programmers can have a readable text to write and can edit machine-code programs by using the medium of an assembly language. Taking the Commodore Assembler as an example, Mike Gross Niklaus gives a detailed explanation of how you can put an assembler to work on your programming problems.

Assembler programs

BASIC PROGRAMMERS moving on to machine code often find the assembly process long and complicated, which is a pity because an assembler package is an excellent tool for creating machine-code programs. This article guides you through the assembly process using the Commodore assembler package.

The 6502 processor, like any other, works using pulses of electricity which operate electronic gates placed on the various electrical paths within it. A particular pattern of pulses, called an instruction, causes the microprocessor to carry out a particular operation. These instructions, together with the data on which they are to operate, are held in memory as electrical charges. The pulses are either on or off, the charges are either present or absent, and so one way of representing the instructions and data on paper is as a series of ones and zeros.

The question then arises, "How does a programmer transform these patterns on paper into electrical patterns in the memory"? Early computer programs were punched as holes on cards, with a hole representing a one or pulse, and lack of a hole representing a zero or no pulse. A card reader sensed the holes and created the appropriate electrical pattern.

While cards solved the entry problem, programmers were left with the awful task of writing their instructions as ones and zeros. If that chore failed to turn them cross-eyed, then trying to read these patterns a week or two later, and amending them to get rid of errors or to enhance the program was enough to floor all but the most dedicated. If it was someone else's program, then it was quicker to start from scratch. Editing and patching programs frequently caused new errors to be created as fast as the old ones were corrected.

Soon the ones and zeros were replaced by hexadecimal representations. Programs could then be written using the 16 symbols 0 to 9 and A to F. Hexadecimal is much easier to read than rows of ones and zeros, but the editing problem remained.

Assembler language was invented to overcome this problem. It allows the programmer to write and edit machine-code programs using a quite readable text, and including as much annotation and as many named variables as may be needed. This text can be saved away, pulled back, changed, edited in any way you like and re-saved, using an editor program. This text is called the source code.

You use an assembler program to process the source code. It ignores all the annotation, converts all the variables' names into actual memory addresses, and produces and saves a hexadecimal code version of the program called the object code.

Simple problem

Finally you use a loader program to read the object code, translate it into ones and zeros and place the patterns in memory. Provided the machine-code program works correctly, you can save it using the normal monitor facilities, which enable you to save away any specified chunk of memory, and later read it back into position. So from then on you need only load this memory version without going through the assembly process.

Usually there will be errors, so you will have to re-load the editor, get back your source code, edit it and go through the assembly process again. Newcomers to assembler code, particularly those of you used to Basic alone, will get frustrated on many occasions, complaining of this long-winded process. All I can say is, "You cannot imagine the hassle we had before assemblers came along", and "Wasn't it nice of the folks at Dartmouth to develop Basic".

The outline of the assembly process is shown in figure 1. We can follow it through with a very simple programming problem: placing the initial letters of the words "personal computing" in the top left-hand corner of the screen.

In Basic, you could achieve this by a couple of Poke instructions along the following lines:

```
POKE 32768, 16 : REM 32768 IS T/L
SCREEN
POKE 32769, 3 : REM 16 AND 3 ARE P AND C
```

The machine-code program works in a similar way. The first step is to write the source code on paper. Using the 6502 opcode mnemonics and addressing modes, which are specified in the MOS 6502 programming manual and used by the Commodore assembler, you could write:

```
LDA #16
STA 32768
LDA #3
STA 32769
RTS
```

You have to decide where this program is to sit in memory, and then tell the assembler. The Commodore assembler has a set of directives which are instructions written in the source code. They are not 6502 codes but instructions to the

assembler program itself. One of these — * = — can be used to specify where the final program should reside. Another — ; — is used in exactly the same way as a Basic Rem statement.

The assembler also has the ability to translate symbolic names into actual values and even perform simple calculations on symbols to establish final values for assembly. For example, you can represent the screen locations 32768 and 32769 by SCRTOP and SCRTOP + 1. At some point in the source code, normally the start, you need to define the value of SCRTOP.

Like Basic, source-code lines must be numbered to allow listing, line deletion, etc. A source-code listing for our problem might look like:

```
1000 ; TOPLEFT PC
1010 ; M.J.G-N
1020 ;
1030 SCRTOP=32768
1040 ;
1050 * = 826 ; ASSEMBLE IN
1060 ; 2ND CAS BUFF
1070 LDA #16 ; CODE FOR 'P'
1080 STA SCRTOP ; SCR T/L
1090 LDA #3 ; CODE FOR 'C'
1100 STA SCRTOP+1 ; LOC 32769
1200 RTS ; TO BASIC
1210 ;
1220 END
```

The final line — End — is another directive to the assembler telling it that there is nothing further to assemble.

Transfer to disc

The next step is to transfer this source code from paper to a disc file ready for the assembler to process. This is done using the editor program to create text in memory, much as you do for a Basic program. In the Commodore package there are versions for both 16K and 32K machines.

Suppose you are using a 32K machine, you type

```
LOAD "EDITOR32K", 8
```

Since it is a machine-code program which resides at the top of memory, you cannot Run the program but must enter it with a Sys call. The call for the 32K version is

```
SYS 28672
```

You will get a message announcing the editor and Ready and a flashing cursor.

The editor is now operational, and you can enter source-code lines in exactly the same way as you do lines of Basic. But be warned: although line deletion, insertion, cursor movement, character otype, deletion and insertion all work as for the

(continued on page 111)

'CFACC'

THE BEST ACCOUNTS PROGRAMME ON THE MARKET — £900.00

MAIN MENU

- | | |
|--------------------------|----------------------------------|
| 1. ADDRESS PROGRAMME | 16. BANK RECONCILIATION |
| 2. SALES INVOICES | 17. PURCHASE LEDGER |
| 3. PURCHASE INVOICES | 18. SALES LEDGER |
| 4. STOCK CONTROL | 19. END OF MONTH PROCEDURE |
| 5. ORDER CONTROL | 20. V.A.T. STATEMENTS |
| 6. PAYROLL | 21. JOB COST ANALYSIS |
| 7. PAYMENTS MADE | 22. PROFIT & LOSS ACCOUNT |
| 8. PAYMENTS RECEIVED | 23. BALANCE SHEET |
| 9. CREDITORS | 24. CAPITAL ASSETS |
| 10. DEBTORS | 25. MANAGEMENT FINANCIAL REPORTS |
| 11. SUPPLIER STATEMENTS | 26. DISK CHANGE |
| 12. CUSTOMER STATEMENTS | 27. ALTER INCORRECT FILE ENTRIES |
| 13. AGENTS STATEMENTS | 28. PRINT LEDGER CODES |
| 14. PRINT CUSTOMER INDEX | 29. PRINT STOCK LIST |
| 15. PRINT SUPPLIER INDEX | 30. FINISH USING 'CFACC' |

PLEASE ENTER SELECTION NUMBER

'CFACC' Accounts Programme — Copyright COMPUTERS for ALL Ltd.

- The Programme resides totally "in core" leaving BOTH DISKS FREE for files and enabling disks to be changed during use.
- Every Programme issued is "PERSONALISED" with your Company's details. Our After Sales Service is Positive giving you constant access to the Author of 'CFACC'. No two businesses are the same. You can have a fully modified version of 'CFACC' to your own requirements for £1200.00.
- You need only enter invoices and payment in and out and 'CFACC' will produce all the DATA for the MENU Programmes (It will ask the user for any other information it needs).
- All relevant information is stored for CUSTOMERS, SUPPLIERS, EMPLOYEES, and Others.
- Automatic V.A.T. Calculations.
- Automatic calculations of WAGES and SALARIES
- INVOICES can be produced automatically using Customer's names and addresses from file and Stock items from file — All calculations are automatic.
- INVOICES re automatically printed on plain paper ('CFACC' can be easily and cheaply adapted by us to print on your own
- STOCK FILE is automatically UPDATED whenever a Purchase or Sales Invoice is entered and the User's attention is drawn to any item which has reached RE-ORDER LEVEL.
- CUSTOMER and SUPPLIER STATEMENTS are printed on demand showing Current, 1 Month, 2 Month, and 3 Months and Over figures. These are automatically updated as payments are entered. The User's attention is automatically drawn to any Customer exceeding his CREDIT LIMIT.
- Automatically calculates COMMISSION due to Agents and Salesmen.
- DEBTOR and CREDITOR Lists available on demand.
- PROFIT & LOSS ACCOUNT, BALANCE SHEET, and TRIAL BALANCE printouts on demand.
- MANAGEMENT FINANCIAL REPORTS include: — i) GROSS PROFIT RATIO ii) RATE of STOCK TURNOVER iii) NET PROFIT as a PERCENTAGE of SALES iv) INCOME STATEMENTS v) AGE of DEBT ANALYSIS
- CAPITAL ASSETS STATEMENT on Demand
- INCOME & EXPENDITURE is analysed into 80 Ledger Classifications and the Amounts in any one of these can be called at any time.
- ENVELOPES or ADDRESS LABELS can be printed from the Address Files.
- Full Random Access to any Record in any File — No Limit on Record Lengths as in some programmes.
- LEDGERS are automatically updated after every transaction.
- All sections of the Programme and the Files are fully integrated.
- Some Programmes on the market claim to be easy to use with no need for manual BUT TO THE LAYMAN THEY SIMPLY ARE NOT.

'CFACC' really is USER ORIENTATED

WE ARE PREPARED TO LET YOU PROVE THIS FOR YOURSELF
MONEY REFUNDED IN FULL IF YOU CAN SHOW US A BETTER MICROPROCESSOR
FULLY INTEGRATED ACCOUNTS PROGRAMME WITHIN 7 DAYS OF USE.

- The PRICE makes 'CFACC' the best VALUE for MONEY on the market.
- Fully tested and debugged. You will receive Free of Charge any Improvements or Modifications we make in the future.
- All equipment is fully tested by us prior installation — Normal Guarantees on all Equipment and we only recommend the most reliable — Service Contracts available — Finance & Leasing a speciality.
- DELIVERY and INSTALLATION FREE of Complete Packages within the U.K.
- Pets, Apples & Tandys taken in part exchange against complete packages.
- We have examples of other accounts programmes on the market which you are welcome to try and to compare them with 'CFACC'.

64K 'SUPERBRAIN' (350K DISK STORAGE) — DAISYWHEEL PRINTER — "CFACC" ACCOUNTS — "WORDSTAR" Word Processing.

**** ALL FOR £3,886.00 ****

COMPUTERS for ALL LTD

STRATFORD on AVON (0789) 840064

24 Hour Service (Not Machine) on 021-236-1794 Ext 224

(continued from page 109)

Basic editor, the assembler editor does not encode Basic keywords. Consequently, text created with this editor cannot be run as a Basic program. By way of a recompense, it does give you some useful editing facilities: Auto Line Numbering, Repeat Keys, Find String, Change String, Delete Lines, and so on.

Once you have entered the source code correctly, the next step is to store it as a

disc file ready for the assembler to read and process. One reason why it is stored on disc rather than left in memory is that a large machine-code program can then be assembled from several source-code texts linked together, which in total would take up more store space than is available.

The editor provides a command, Put, which stores the text as a sequential file. You must specify the drive, but the editor assumes you mean device 8 unless you say

otherwise. So to store the source code for this problem, you would type

```
PUT "0:TOPLEFTPC.S"
```

The .S is not obligatory, but it is best to differentiate source-code files from object-code files and so on. Some programmers use .SRC and .OBJ.

To recover the text to do some editing, the editor provides a Get command — not to be confused with the Basic Get, which you cannot perform directly anyhow. This one reads back a source file from disc. To get back the text you have just stored, you will type

```
GET "0: TOPLEFTPC.S"
```

Once re-editing is complete, you can Store and Replace using the @ symbol

```
PUT"@0:TOPLEFTPC.S"
```

The assembler is also a machine-code program, but occupies the lower end of user RAM, so the same version does for both 16K and 32K machines. However, two versions are included for 66-line paper and 72-line paper. This seems to be a very roundabout way of tackling the problem of different page lengths, and is one of very few gripes I have with the Commodore assembler package. Assuming you are using 66-line paper you load the assembler program as follows

```
LOAD "ASM66",8
```

Although the assembler is a machine-code program, it has a short Basic routine latched on the front, so you Run.

Assembler printout

After an identity and copyright announcement, you are asked for the object-code file name. Get into the habit of using the same generic name for source, object and machine-code files, with an appropriate descriptor — e.g., .OBJ or .O — tagged on the end. In this case you might reply

```
0:TOPLEFTPC.O
```

You are then asked if you require the assembly listing to be printed, as opposed to being displayed on the screen. You reply Y Return if you want the listing printed, or N Return if you do not. The program then asks you if an IEEE-488 protocol printer is being used. What it really means is "Does your printer understand Commodore's version of ASCII or standard ASCII"? If you have a Commodore printer, reply Y Return, otherwise reply N Return.

As a final question, the program asks for the name of the source-code file. In this case you would reply 0:TopLeftPC.S. As soon as you press the Return key the assembler bounds into action, producing a printout — figure 2.

The source code is shown on the right. The left-hand column is the assembly listing line number, the next is the location in memory of the instruction displayed in hexadecimal, and the third column shows the instruction — both op code and zero-, one- or two-byte operand — again in hexadecimal.

(continued on next page)

Figure 1. Outline of the assembler process.

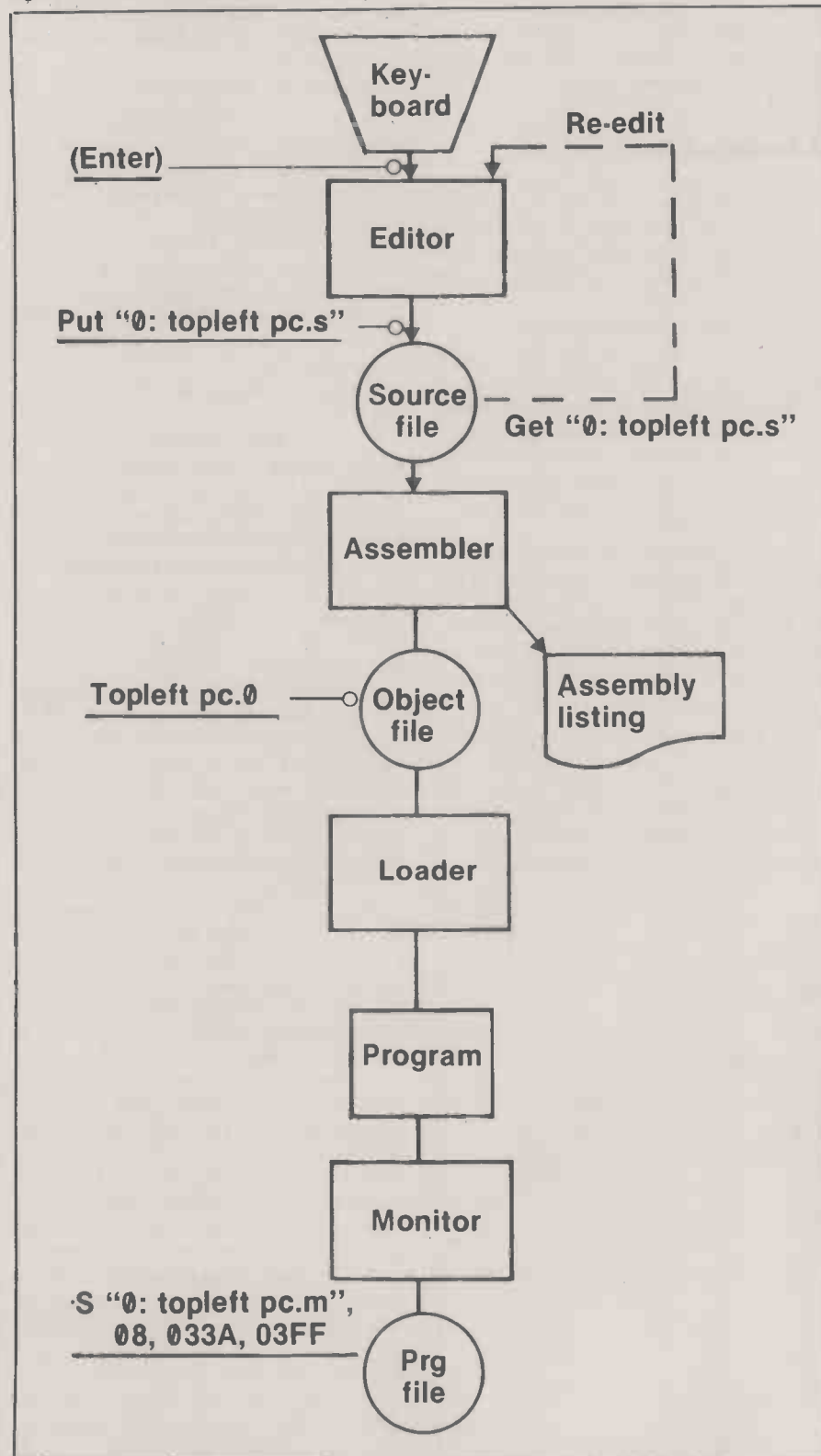

(continued from previous page)

The assembler works by converting all the op-code mnemonics into hexadecimal, evaluating all the symbols and expressions and turning them into hexadecimal as well. In order to deal with the symbols properly, it reads the source code right through, creating a table of symbols and values for the symbols. It then reads the source code a second time, replacing symbols by values, sending the resultant hexadecimal to an object-code file, with the name you specified at the start of the run. At the same time it produces the assembler listing.

Any errors are highlighted with rows of asterisks and an upward arrow pointing to the place in the source code line where the error was detected. The total number of errors is printed at the end of the assembly listing. The final part of the listing is a printout of the symbol table already described, together with their hexadecimal values.

If you do have errors, you can Get back your source code — the editor is still present and active — correct it, and restore it, load the assembler again — remember that source text and assembler occupy the area of user RAM — and reassemble the program.

We can now assume that you have assembled your program without error, and have on disc an object-code sequential file consisting of the hexadecimal representations of the machine-code program, preceded by pointers showing where these values are to be placed in the memory of the machine. To load these values into RAM requires a loader program.

Since you might want to put your machine-code routine in exactly the area of RAM occupied by the loader program, Commodore has provided three versions. The first loads into the bottom of user

RAM, i.e., where Basic text, source text and the assembler program are placed. The other two load to the top of 16K and 32K memory respectively.

There appears to be some kind of clash over re-direction of operating-system vectors when using the high loader immediately after using the editor. You have to do a cold start before loading and running it. Later versions of the editor provide the Cold command to do just this, but on earlier versions you have to use Sys 64721 — Basic 2 — or switch the machine off and on again. You then load Hi-Load16 or Hi-Load32, and enter with the appropriate Sys command — Sys 28672 for Hi-Load32.

Advanced facility

Our example program, however, is to be placed in the second cassette buffer at location 826. It is clear of user RAM, which is why it is often used for short routines. You can use the low loader with no vector troubles:

```
LOAD "LOADER",8 : RUN
```

The Loader program first asks you if there is to be any offset. This is an advanced facility of limited use, allowing you to offset the loading position of the object code from the area specified in the source code. Unless you know exactly what you are doing, press Return alone to ignore the facility.

The next and final question asks you for the name of the object file. Get into the habit of specifying the drive number, as the 8032 version of the assembler loader requires it. You reply with the same name as you used during the assembly run

```
0:TOPLETPC.O
```

The hexadecimal symbols representing loader pointers, op codes and operands appear on the screen to confirm that your machine-code program has been loaded.

Drawing a deep breath, you type Sys to

whatever location your program starts at, or include the Sys call in a Basic program. In our example you use

```
SYS 826
```

At this point, a broad smile should break out on your face as P and C appear at the top left of the screen.

Assuming that you are happy with the result, you can save it on to disc as a program, using the facilities of the Pet resident monitor. From then on, a Load command from Basic, or from the monitor, will load the program without the hassle of calling up the loader and reading the object file.

To enter the monitor, type

```
SYS 1024 RETURN
```

or if the editor is still active you can type Break. You will see a hexadecimal report on the condition of various registers of the 6502 and the flashing cursor sitting to the right of a full stop. The Save command in monitor is .S followed by the normal string specifying drive and file name, followed by device number, start and end location +1 for your program — all three in hexadecimal.

For small programs in buffer 2 I tend to specify

```
$033A TO $03FF
```

to save having to discover the actual end — you can look this up on the assembler listing if you want. So for our example, the Save command will look like this:

```
.S "0:TOPLETPC.M",08,033A,03FF
```

The .M is my personal way of describing a machine-code module saved from memory. A more common convention is .Bin for binary.

Having read this far, you are probably thinking that you have an awful lot to learn. But the many people who attend the courses I run on machine code with assembler, write their first successful machine-code program within an hour of starting the course. After three days they can rattle through the procedures without a second thought.

There are several assembler packages on the market which may vary slightly in procedure from the Commodore package. Some assemble into store, others use different addressing representations from those recommended as a standard by MOS Technology.

Putting aside my connection with Commodore, as an independent machine-code programmer I recommend the Commodore package. For £30, you not only have the editor, assembler and loaders, but also the disc-support program, a re-locator utility and the very useful Extramon which contains numerous diagnostic and trace aids, a mini assembler and a disassembler. The diskette in the package also contains the source-code listings for the editor, loader and re-locator. Apart from showing how to use many useful entry points in the Pet's ROMs, they provide excellent examples of assembly-language technique and layout. 

LINE#	LOC	CODE	LINE
0001	0000		:TOPLEFT PC
0002	0000		:M.J.G-N
0003	0000		:
0004	0000		SCRTOP=32768
0005	0000		:
0006	0000		*=826
0007	033A		:ASSEMBLE IN
0008	033A	A9 10	2ND CAS BUFF
0009	033C	8D 00 80	LDA #16 ;CODE FOR 'P'
0010	033F	A9 03	STA SCRTOP ;SCREEN T/L
0011	0341	8D 01 80	LDA #3 ;CODE FOR 'C'
0012	0344	60	STA SCRTOP+1 ;LOC 32769
0013	0345		RTS ;TO BASIC
0014	0345		.END
ERRORS = 0000			
SYMBOL TABLE			
SYMBOL VALUE			
SCRTOP 8000			
END OF ASSEMBLY			

Figure 2. Assembler printout.



NOW YOU CAN BUY THE BEST HOME COMPUTER IN THE WORLD.

Commodore's brilliant new VIC20 home computer is at your dealer's today. Now you can get your hands on the world's best home computer, we're sure you won't be disappointed.

Here's a brief reminder of VIC's many features:

A typewriter keyboard with graphics.

5K Memory—expandable to 29.5K user RAM.

8 programmable function keys.

High resolution graphics.

Music in three voices and three

octaves, as well as sound effects.

Eight border colours and sixteen screen colours.

All in a superbly-designed, compact unit with built-in facilities for expansion.

Now you can take a look for yourself. And even take VIC home tonight.

 **commodore**
COMPUTER

For more information on the VIC 20, telephone or write to: Commodore Information Centre, Baker Street, High Wycombe, Bucks, or Tel: Slough 79292.

Approved
Dealers

Aberdeen

MOM Offshore
21 Bon Accord Street
Tel: 0224 22863

Belfast

O & M Systems
95 Dublin Road
Tel: 0232 49440

Birmingham

Byteshop Computerland
94/96 Hurst Street
Tel: 021 622 7149

Bristol

Senton
27 Nicholas Street
Tel: 0272 276132

Cambridge

Toltec
24 Thompson Lane
Tel: 0223 312347

Cheshire

Holdene
82a Water Lane
Wilmslow
Tel: 0625 529486

Dublin

Lendac Data Systems
8 Dawson Street
Tel: 0001 372052

Edinburgh

Holdene Micro Systems
Bristo Street
Tel: 031 668 2727

Glasgow

Byteshop Computerland
61 Waterloo Street
Tel: 041 221 7409

Leeds

Holdene Micro Systems
11/12 Rampart Road
Tel: 0532 459459

London

Byteshop Computerland
324 Euston Road, W1
Tel: 01-387 0505

Digitus

9 Macklin Street, WC2
Tel: 01-405 6761

Jarogate

67 Tulsemere Road, SE17
Tel: 01-670 3674

Manchester

Byteshop Computerland
Piccadilly Station Approach
Tel: 061 236 4737

NSC Computers

29 Hanging Ditch
Tel: 061 832 2269

Newbury

Newbear Computing Store
40 Bartholomew Street
Tel: 0635 30505

Nottingham

Byteshop Computerland
92a Upper Parliament Street,
NG1 6LF
Tel: 0602 40576

Sheffield

Hallam Computer Systems
451 Eccleshall Road
Tel: 0742 663125

Southampton

Xitan Systems
23 Cumberland Place
Tel: 0703 38740

Suffolk

Eurotec Consultants
Little Waldingfield,
Sudbury
Tel: 0787 247959

Surrey

Gemlines
184 London Road, KT2 6QU
Tel: 01-546 9944

Warwick

Business & Leisure
Microcomputers
Kenilworth
Tel: 0926 512127

Watford

Lux Computer Services
108 The Parade,
WD11 2AW
Tel: 0923 29513

Worthing

Ace Computing Services
1-11 Bridge Road
Tel: 0903 35411

Comart Ltd.

St. Neots, Cambs.
Tel (0480) 215005
Telex 32514 Comart G.

comart communicator

The clean simplicity outside...



**NOW WITH 5 MEGA-BYTE
HARD DISK DRIVE**

...conceals the pedigree inside.

First came the Communicator CP100, a British designed, British made Microcomputer; Z80A processing power, Twin Floppy Disk Drives, S100Bus Construction, CP/M operating system, neat compact styling, and a standard of engineering reliability uncommon in such a new system.

In just a few short months Communicator was the focal point of a new range of Microcomputers.

It offered floppy disk drive options, double density, quad capacity, and 80 track quad capacity. It offered floppy disk and s100 bus expansions. It had a 20 Megabyte Hard Disk Sub System and Cassette Back up.

Now there is Communicator CP500, a dedicated system within a System. CP500

provides over 5 Megabytes of on-line data storage with its integral 5 MegaByte 5" Winchester Technology Hard Disk and very high capacity floppy disk drive.

To the user, CP500 means greatly improved utility. It will support larger scale computer operations at several times the speed and commence of the conventional floppy disk systems. And it offers greater application flexibility, with reduced operator involvement in diskette management routines.

Find out more about the Communicator range today.

comart

SPECIALISTS IN MICROCOMPUTERS

A member of the Comart  Group of Companies.



CHOOSE ATOM POWER

At work or play - everything you need in a personal computer

The Atom is a machine to be used. Every day, day after day. It's a full function machine - check the specification against others. It's rugged, easy to operate built to last and features a full-size typewriter keyboard.

Just look at some of the features!

- More hardware support than any other microcomputer
- Superfast BASIC - can be updated to BBC BASIC if required
- High resolution and comprehensive graphics ideal for games programmers and players*
- Integral printer connection*
- Software available for games, education, maths, graphs, business, word processing, etc.
- Other languages: Pascal, FORTH, LISP
- I/O port for control of external devices
- Built-in loudspeaker
- Cassette interface
- Full service/repair facility
- Users club

* Expanded version only

Optional Extras

- Network facility with Econet
- Disk ● PAL UHF colour encoder
- Add-on cards include 32K memory, analogue to digital, viewdata VDU, disk controller, daisywheel printer, plus many, many more!
- Power supply

FREE MANUAL

The Atom's highly acclaimed manual comes free with every Atom and leaves nothing out. In just a while you'll be completely at ease with your new machine! Within hours you'll be writing your own programs.

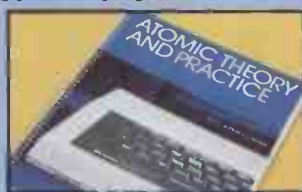

YOU AND YOUR CHILDREN

More and more schools are buying Atoms. More and more children will learn on an Atom. You can give them that extra familiarity with an Atom in the home.



4a Market Hill,
CAMBRIDGE CB2 3NJ

When you order your Atom we will include full details of all software packs and the optional hardware.

To: Acorn Computer Limited, 4A Market Hill, Cambridge CB2 3NJ.

I enclose a cheque/postal order for £.....

Please debit my Access/

Barclaycard No

Signature

Name (please print)

Address

Telephone Number

Registered No. 1403810 VAT No. 215 400 220

Quantity	Item	Item price inc. VAT + P&P	Totals
	Atom Kit 8K ROM + 2K RAM	@ £140.00	
	Atom Assembled 8K ROM + 2K RAM	@ £174.50	
	Atom Assembled 12K ROM + 12K RAM	@ £289.50	
	Power Supply	@ £ 10.20	
	TOTAL		

ATOM SOFTWARE is designed and produced by Acornsoft, a division of Acorn Computers, Trust the manufacturer to get the very best from its own product. Current software includes word processing, maths packs over 30 games, database, Forth and business packages.



Write to Acornsoft, 4a Market Hill, Cambridge for full details and prices.

SEE OUR DEALER LIST ON PAGE 238

Dealers, we'll help you out of the microcomputer jungle.



The small business market is where the action is. But that's where it's a real jungle. The small machines are running out of steam and the big ones are priced too high. In between, there are some good products. But how often do they provide the mix of reliability, software back-up and maintenance support you'd really like? Not often! And that's a situation we'd like to rectify.

Easier said than done, of course. But then we are part of the multi-million pound MBS group which specialises in many aspects of the computer business — from equipment sales and rental to maintenance, repair and software development.

Our first step has been to find the right micro. After looking long and hard in Japan, the US and Europe, we selected Altos¹. This is a range of computers which

has won a reputation for continuing standards of build quality and long-term reliability (in the 1981 Datapro² survey 100% of users said they would recommend Altos to other users).

The entry level Altos is a 64K, Z80A³ based system with two highly dependable 0.5 Mb 8-inch floppy drives. All at a remarkable end-user price tag of £2,200. For more capacity, the range also includes multi-user, Winchester-based systems and an advanced 16 bit machine (to be released next month). Altos runs CP/M⁴, MP/M⁵ and the super-fast OASIS⁶ operating systems, CP/M-86⁷, OASIS-86⁸ and UNIX⁹ for the 16 bit system.

Right now, because we want these beautiful machines to be seen at work, we're busy recruiting a first-class dealer network. So dealers, if you want a way out of the jungle, we'd like to hear from you

We'll explain what Microtex support is all about...software expertise...training...dealer stocking plans...leasing, rental, hire facilities...seven repair centres offering 4-hour response for field service. And we'll prove Altos is tops for quality engineering.

Microtex Ltd, 119/120 High Street, Eton, Windsor, Berkshire SL4 6AN.
Telephone (Windsor) 07535 55211
From London 95 55211 Telex 848945

ALTOS

FROM MICROTEx

Registered trademarks: ¹Altos Ltd, ²Datapro, ³Zilog, ⁴CP/M, ⁵MP/M, ⁶OASIS, ⁷CP/M-86, ⁸OASIS-86, ⁹UNIX, ¹⁰Bell Laboratories

The question of perfect answers

Just before she died, Gertrude Stein asked: "What is the answer"? No answer came. She laughed and said: "In that case, what is the question"? Then she died. Boris Allan picks up where Gertrude Stein left off, and offers some intriguing answers to the question of programming perfection.

A PROGRAM is no more than an answer to a question, and a bug-free program is a perfectly correct answer to the question. But what is the question that is being answered?

Study this bug-free Basic program:

```
10 REM PROGRAM 1
20 INPUT A
30 B = SQR(A)
40 PRINT A,B
50 END
```

It will work every time, unless a negative number is entered — there is no defined square root of a negative number in Basic.

The next attempt to write a bug-free Basic program could be:

```
10 REM PROGRAM 2
20 INPUT A
30 IF A < 0 THEN 70
40 B = SQR(A)
50 PRINT A,B
60 END
70 PRINT "ERROR : NEGATIVE NUMBER"
80 END
```

Program 2 will work every time, unless a letter or incorrectly-formed number is entered, for example, £.&.

A further attempt to write a bug-free Basic program might take the form:

```
10 REM PROGRAM 3
20 INPUT A$
30 GOSUB 1000
40 IF E = 1 THEN 80
50 B = SQR(A)
60 PRINT A,B
70 END
80 PRINT "ERROR : INCORRECTLY
FORMED NUMBER"
90 END
1000 REM ERROR HANDLING ROUTINES
1010 REM IF ERROR E = 1, OTHERWISE
= 0
1100 RETURN
```

Of course, Program 3 will perform perfectly, unless . . . As James Stephens writes in *The Crock of Gold*: "Nothing is perfect. There are lumps in it".

Program 1 is, in one sense, bug-free because the program logic was a perfect answer to the logic implied in the question "How can one write a Basic program to enter a number, calculate its square root, and output its value"? The answer was perfectly admissible — and there would be many equally admissible answers — as

long as the range of values to be entered was positive, and not too large.

Possibly some automated procedure for deciding program correctness could have isolated the potential problem to do with ranges of admissible values, and the procedure may have given solutions such as programs 2 and 3. The decision procedure would need to have been set up in such a way that the range problem could be recognised; but to set up a general decision procedure to check total program correctness would be impossible.

It is clear that there are levels of program correctness. The most trivial level is the translation of a set of instructions, for example,

Enter a number;
Output the number and its square root;
into statements in a programming language. Program 1 is the answer to the question "How is this set of instructions to be translated into statements in the programming language"?

Some answers are more accurate than others. Program 1 is bug-free — i.e., perfect — if it is seen as the answer to the question put by the given set of instructions, but the question is inadequately formulated since the instructions are not very comprehensive. The question to which program 3 is an answer is also inadequately formulated: it would certainly be possible to beat the system in some way, for example, there is no such thing as a completely un-copyable disc.

Consider the original question to which program 3 is the ultimate answer: "How can I get the computer to calculate square roots for me"? To go from this question to another question — the set of instructions — is a process of formulation, and can be a highly creative activity.

Once you have formulated the answer, which is in itself an implicit question, there now becomes necessary a process of integration. The language, operating-system characteristics, the relationship of this program with other programs, and many other problems — such as the square root of minus numbers — need to be considered.

Following this is the process of translation from the answer provided by the formulation and integration to the final answer, the program.

The process I have called formulation, together with much of integration, corresponds to what is normally termed systems analysis. The rest of integration, together with translation, corresponds to programming. In real life there is a continuous interplay between formulation and integration; and lately, translation has not

been left to a separate person either. All three interact.

Perfection can only really be assured in the translation process. This is what is usually meant by claims to bug-free programs. If the questions to which answers are required are greatly restricted in scope, perfection — or fewer errors — is easier to claim. If the environment for the integration process is restricted — e.g., by using only one language, or only files of a certain form — then the likelihood of error is reduced.

If perfection is possible in certain restricted senses, then the claim to a procedure to generate bug-free programs may be accurate, even though the range of application is very narrow. The price you pay for automatic perfection is a limitation on what you can do, and emphasis on translation at the expense of formulation and integration.

A program to write programs must, if it is to work, only answer a very restricted set of questions. Even then, it will only be able to implement the translation process, which is the only easily-implemented automatic procedure and could quite possibly produce bug-free programs.

Limited application

Any automated procedure which works will be able to claim to generate totally bug-free — i.e., perfect — programs. Yet there will still be bugs in the formulation and integration of answers to the original question — unless the user has superior analytical and creative faculties — so the perfection of the program written by the program generator will always be in question. The same can be said of the perfection of any program, including the program generator.

How can this doubtful perfection be resolved? One probable strategy by the promoters of any program generator will be to restrict its range of application — paying the price for automatic perfection by limiting what you can do. Some restrictions which come to mind concerning integration are:

- using only one language;
- having a fixed operating system;
- only allowing restricted types of files;
- minimising the types of mathematics one can use.

These restrictions are probably the least number that will appear in any program generator. Some of them you will be told about, others will come to light when you find that you cannot do what you want to do.

At the level of formulation, any program generator must restrict its range of

(continued on next page)

(continued from previous page)

application to a very limited area, e.g., financial management, simulation or matrix mathematics. Programs already exist which translate programs written in one language, say, Algol 60, to programs written in another language, say, PL/1.

For any computer to run a program there must be another program — the compiler — which translates the first program into machine instructions. One would suspect, therefore, that the overall shape and flow of any program outline must be very carefully defined, in great detail, before any program generator can operate.

Such a program generator would not be new, because what normally happens is that the source generated is not listed, but merely compiled. In the Genesys system for use by civil and structural engineers, programs written in a language called Gentran are converted into Fortran source. The source is not usually listed as it is compiled into object code.

Creative imagination

If a program generator did provide all the programs the user needed, then the user would only be doing a restricted set of tasks, i.e., asking a very restricted set of questions. To claim perfection of the resulting programs — i.e., no bugs — might be justified, but errors in logic, i.e., in formulation, are far more devastating and need creative imagination to solve. The response of the promoters of such generators to programs which did not work would probably be to blame the user's program logic though perhaps the logic would go astray mainly because the user has to modify his own logic to accommodate the generator, with resulting confusion.

Rather than talk in the abstract about what might happen if a generator of bug-free programs were to be produced, consider a different variety of bug-free program generator, a program generator which has been available for many years.

At the 1981 conference of the British Computer Society, C A R Hoare claimed that if programmers used certain standard techniques for program writing it should be possible to produce software with no bugs at all. In other words, the claim is that:

either there is a general decision procedure to check total program correctness and produce perfect programs,
or there are means available to generate correct programs at the translation stage, with probable restrictions on formulation and integration.

Hoare is one of the prime promoters of Pascal, and it would seem reasonable to suppose that Pascal embodies the standard techniques for program writing implied in Hoare's claim. Therefore, we need only study Pascal to learn these techniques.

To write a perfect — bug-free — program is of little value if the formulation

and integration aspects are flawed. I have already described several possible restrictions concerning integration for a program generator. Pascal obviously is restricted in being a single language and having a fixed type of file: the only type of file allowed in standard Pascal is the sequential file.

Pascal also has many restrictions on mathematical operations. There are silly rules for matrices, and it is impossible to bring real numbers into their axiomatic system — the axiomatic system upon which is based the assertions concerning perfection. A possible reason for this problem with real numbers is that Pascal Types, apart from the Real, are based on the idea of a Set Of. However, when one considers real numbers on the computer, the sets have an infinite number of elements. The list of such restrictions could be extended.

In formulation, any program generator must restrict its range of application, unless the program generator is human. Pascal was originally designed to teach students computer programming, and when attempts are made to use Pascal for answering questions outside this particular application, the logic becomes increasingly devious. Pascal is useless for serious mathematical and scientific work in a communal environment with libraries of applications procedures.

It is claimed that Pascal has a great utility in compiler writing, partly due to its reputation for ease of bug-free translation. Yet Richard Bornat in his book *Understanding and Writing Compilers* (Macmillan, 1979) clearly asserts that he would have used Pascal more extensively for compiler writing were it not for the fact that its lack of block structure, lack of conditional expressions and lack of a simple "union-type" convention forces an obscure programming style.

What the advocates of Pascal promise is a bug-free program generator called Pascal, which will take many years to master in its program-proving aspects. Due to the necessary limitations on formulation and integration, this language will not be as flexible as many other languages in answering questions. Similarly, any future bug-free program generator will, due to the necessary limitations on formulation and generation, not be as flexible as most programmers in answering questions.

Bug-free programs can be written, in that perfect translations can be made of the logic which appears after formulation and integration of an answer. But surely the emphasis should be placed not on this perfection in preference to the perfection of formulation and integration. You may wonder whether translation is emphasised because it is the most routine of the aspects of creating a program. The emphasis on creation seems to be sadly lacking in the playing down of the imagination needed in formulation. □

HOME COMPUTER RETAILERS

BEDS

Computopia, Leighton Buzzard (376600)
Comserve, Bedford (216749)
Electron Systems (Sandy) Ltd, Sandy (81195)
Texas Instruments Ltd, Supply Division,
Bedford (67466)

CAMBRIDGESHIRE

Intelligent Artefacts
Cambridge (207689)

DEVON

JAD Ltd, Plymouth (29038)
Peter Scott (Exeter) Ltd, Exeter (9076842)

ESSEX

Maplin Electronic Suppliers,
Westcliff-on-Sea (554000)

HANTS

The Maths Box, Southampton (22958)
RDS, Portsmouth (812478)

HEREFORDSHIRE

Acoutape Sound, Bromyard (3280)

HERTS

Computer Centre (Watford) Ltd, Watford (40601)
Computer Plus, Watford (020449)

HUMBERSIDE

Radius Computers Ltd, Hull (227181)
Peter Tutty & Co, Hull (41458)

LEICS

Boots Company Ltd, Leicester (21641)

LONDON

Adda Computers Ltd, W8 (579-5845)
Eurocalc Ltd, EC2 (729-4555)
Landau Electronics Ltd, W1 (642-5986)
McDonald Stores, W1 (636-2877)
Mountandene Ltd, NW11 (455-9823)
Selfridges, W1 (629-1234)
Sumlock Bondain Ltd, EC1 (250-0505)

NORFOLK

Angla Computers, Norwich (29652)

NORTHANTS

Computer Contact, Rushden (55673)
Computer Supermarket, Corby (61587)

NOTTS

Bestmoor Ltd, Nottingham (415315)

OXON

Science Studio, Oxford (54022)

S. GLAM

Computer Business Systems Ltd,
Ely, Cardiff (562255)

S. YORKS

Datron Interform, Sheffield (585490)

W. MIDLANDS

Taylor Wilson Systems Ltd,
Dorridge, Solihull (79404)

W. SUSSEX

Gamer, Brighton (698424)

W. YORKS

Ackroyd Typewriters Ltd, Bradford (31835)
Bits and PCs, Wetherby (63744)

SCOTLAND

Esco, Glasgow (427-5497)
Robox Ltd, Glasgow (221-5401)

IRELAND

Texas Instruments Ltd,
Supply Division, Dublin (609222)

RUMBELOWS STORES STOCKING

HOME COMPUTER

BEDS

Bedford (59339)
Dunstable (602618)
Arndale Centre, Luton (414480)

BUCKS

Bletchley (73505)
Central Milton Keynes (662120)

HERTS

Boreham Wood (953-1744)
Hatfield (64211)
Hemel Hempstead (53223)
Hitchin (59203)
Hoddesdon (66486)
Letchworth (71231)
Potters Bar (58804)
St Albans (532290)
Stevenage (54303)
Waltham Cross (22100)
Ware (2316)
Welwyn Garden City (27125)
Enfield, Middx. (363-7384)



The TI-99/4A The Home Computer worthy of the name.

Even if you're new to computers, you'll be using the TI-99/4A within minutes of plugging it into any standard TV set. Because the TI-99/4A is a true computer for the home. Immediately accessible to the whole family. All for around £299.

Just snap in one of our wide selection of Solid State Software* Command Modules, touch a few keys, and you're ready to go. The 40 modules can sharpen your children's maths, teach you to win at chess or even help you with household financial decisions. And much more besides. In all, over 400 programs are available.

All enhanced by full music capability and 16-colour graphics.

Another development which sets the TI-99/4A apart from the rest, is our optional Solid State Speech* Synthesiser. Actually reproducing the human voice. With our new Emulator Command Module*, its vocabulary is unlimited.

For data input/output you can use an ordinary audio cassette recorder. And a full-size professional keyboard makes it easy to use.

The TI-99/4A comes with TI BASIC built in. Ideal for when you want to learn programming – and to get you started there's our "Beginner's Basic" course, free with each machine – yet powerful enough for even the most experienced programmer.

To help you get the most from the TI-99/4A you can join the independent users' club. And there's a special magazine ("99'er") available through dealers, or on subscription.

So, if you're looking for a home computer, you can't afford to miss the TI-99/4A for versatility, power and value for money.

- * 16K RAM. Expandable to 48K.
- * 26K ROM including 14K BASIC.
- * Command Modules add up to 36K ROM.
- * 13-digit floating point.
- * Other languages soon – LOGO, UCSD PASCAL, TMS 9900 Assembler.
- * Options – Speech Synthesiser, Thermal Printer, RS-232 Peripheral Adaptor, Disk Memory System.

To find your local dealer check the list on the left, or for more information write to Texas Instruments Ltd., (MS.24), Manton Lane, Bedford MK41 7PA.



THE SOFTWARE THAT EXTENDS YOUR HORIZONS

MicroTechnology Limited is the company who supply all the software you need to expand the potential of the remarkable Sharp MZ80B computer. The company who supply, exclusively, the CPM2.2 that makes the Sharp MZ80B so versatile. The company who supply the software that enables the businessman, the educationalist, the scientist, and the enthusiast to create a better, more efficient, more exciting lifestyle. Just look at the scope.

MICROPRO WORDSTAR Powerful word-processing package, made easy to use by full function key support on the MZ-80B £269	EDIT-80 & FILCOM Line orientated random access text editor. Includes source and binary file compare program. £71	GREAT NORTHERN MINI MODEL Very powerful modelling package, with uses not just in business and financial applications, but in any situation where your model may be affected by external conditions. The buzz-word is WHAT-IF? £399
MAILMERGE Add on to WORDSTAR, provides mail-shot and conditional/parameterised text inclusion. £81 *****NEW*****NEW*****NEW*****NEW*****	MACRO-80 Most popular assembler supporting Z80 [®] mnemonics. Includes linking loader, library manager and cross referencing tool. £119	STOCKFLOW Stock control, which allows large numbers of items with rapid information retrieval. £250
SPELLSTAR Add on to WORDSTAR, allows document spelling checks. Own technical term dictionary can be defined. £135 *****	MICRO TECHNOLOGY EXPAND Library routines for use with MICROSOFT [®] calling sequence products. Gives MZ-80B graphics, cassette and music handling. £65	MAGSAM Indexed sequential access routines, available for use with BASIC-80 and CBASIC. Superb documentation. £110
DATASTAR Screen orientated form definition and data entry tool. £190	CIS COBOL ANSI 74 standard COBOL to full level 1 standard. £425	BASKAM Basic keyed access routines for use with BASIC-80. £95
SUPERSORT I Powerful disk based sort package. Stand alone program and MICROSOFT [®] compatible calling sequence relocatable routines. £135	FORMS-2 For use with CIS COBOL, provides superb screen handling capability for CIS COBOL programs. £100	DATAFLOW Easy to use data file description and entry tool. Will output reports, labels or MICROPRO [®] MAILMERGE compatible files. £99
SUPERSORT II As SUPERSORT I, but only the stand alone program. £108	COMPILER SYSTEMS CBASIC Commercial BASIC, used extensively for business packages. £65	OSFLOW † Open item Sales Ledger £300
WORDMASTER Superb screen based text editor, all functions driven off MZ-80B function keys. £81	DIGITAL RESEARCH PL/1-80 ANSI standard subset G based PL/1 producing direct object code for fast execution. £298	SALFLOW † Sales Ledger £250
MICROSOFT BASIC-80 Accepted standard Microprocessor based BASIC interpreter. £209	BT-80 Record retrieval system for use with PL/1-80, to give data base management facilities. £119	BILLFLOW † Professional client billing. £375
BASIC COMPILER BASIC-80 compatible compiler, makes BASIC programs run many times faster. £236	MAC Upward compatible assembler from ASM, provides MACROs and Z80 [®] assembly support. £53	PURFLOW † Purchase Ledger £250
FORTRAN-80 ANSI standard FORTRAN, except for COMPLEX numbers. £298	ZSID Super symbolic debugger, with full Z80 [®] mnemonic support. Works well with MACRO-80. £59	NOMFLOW † Nominal Ledger £250
COBOL-80 1974 ANSI standard COBOL, with large program chaining and screen DISPLAY/ACCEPT. £448	TEX Text formatter ideal for producing manuals and similar documents. Note this is not screen based. £59	†All these can be integrated into a powerful total control package. Send for further details.
M/SORT Powerful sorting facility for use primarily with COBOL-80. £75	DESPOOL Allows listing of files at same time as other processing. £29	COMPUT-A-CROP *****NEW*****NEW*****NEW*****NEW*****
Mu-MATH & MuSIMP Symbolic math package, allows computation up to 611 arithmetic digits. Superb for scientific and engineering applications. £149	PROSPERO SOFTWARE PRO PASCAL Fastest Z80 [®] based PASCAL that we know of. £190	TARGET PLANNER Business planning system with many features extra to VISICALC [®] . Easy to use, with big machine facilities. £125 *****
Mu-LISP & Mu-STAR Extended LISP 1.5. Includes screen based LISP environment editor. £119	MICROEASE EASYFILER Flexible data definition, data entry, data update and report generator. £275	GRAFFCOM SYSTEMS PAYROLL (annual maintenance fee) £120
		COMPANY SALES SYSTEM £450
		COMPANY PURCHASE SYSTEM £450
		GENERAL ACCOUNTING £400
		STOCK CONTROL SYSTEM £350
		ORDER, ENTRY AND INVOICING £350
		NAME AND ADDRESS SYSTEM £250
		TIME RECORDING SYSTEM £400
		LEASE, RENTAL AND HP SYSTEM £400

WE TAKE ORDERS!

You can order any of the above items of software from us. Today. Personal callers and trade enquiries are welcomed. (All software can only be used in conjunction with the MZ80B including disk-based CPM2.2).

All systems are supplied on 5 1/4" floppy disks and come complete with comprehensive reference manual. All prices will be held for 30 days from the date of issue of this advertisement.

The quoted prices do not include postage, packing, insurance and VAT, so you should phone first for an exact total price. If you wish to pay by VISA or ACCESS card, you can, of course, phone your number through. If you wish to pay by cheque or postal order, make it payable to MicroTechnology Limited.

As most items are available ex-stock, we will normally be able to deliver to you within 72 hours.



The MZ80B Computer.

MicroTechnology

LIMITED

Cheltenham House, 62 Mount Pleasant,
Tunbridge Wells, Kent.
Telephone: 0892 32116. Telex: 95441
Teclin-G.



● Circle No. 169

First time on Earth.



**SHARP
MZ-80B**

Sharp bring you the MZ80B. A machine that offers you functions previously only associated with more powerful, more expensive computers; that gives you versatility to handle a huge range of software and hardware applications in scientific, business and personal use.

The MZ80B opens up a new world of graphic display potential, more flexible data storage and retrieval, and ease of operation.

Here is the computer from the future. Available today.

Stunning Graphic Display.

Seeing is believing. The large-screen, high-focus, green-face display incorporated in the MZ80B gives you high-resolution graphics of 320 x 200 dots.

An additional graphic RAM can be added which allows another 320 x 200 dot resolution pattern to be displayed.

This dual high-resolution graphic ability is especially useful for simulating and displaying a dynamic picture. It can display 40 characters x 25 lines or 80 characters x 25 lines via software switching.

In addition there are facilities for full, on-screen editing, reverse video, partial scrolling and a full range of graphic symbols.

Character and Graphic Printer.

This fast, quiet printer will reproduce your graphic displays and, of course, print-out upper and lower case letters and symbols. A tractor/friction feed version is also available.

Data Storage/retrieval.

The MZ80B has a remarkable memory. 64K of RAM. And that constitutes all the memory area, giving flexible storage of any computer language and its software. The cassette deck is electromagnetically-controlled, with a data transfer speed of 1800 bits/sec combined with a unique

programme search facility to make data storage and retrieval super-fast.



A typewriter-style keyboard incorporates characters and symbols plus a numeric key-pad and ten user-definable keys for fast and simple operation.

BASIC is, of course, provided with Z-80 Assembler Packages, PASCAL and a BASIC compiler.

Floppy Disk Drive.

A twin Floppy Disk Drive unit can be added which will give you 560 bytes of storage on double-sided, double-density disks.



Comprehensive Documentation.

Each MZ80B comes complete with a full set of documentation including an owners' manual giving full circuit diagrams, a monitor reference manual and programming manuals.

Interfaces

RS-232C and IEEE Interfaces are available from January 1982 allowing the MZ80B to communicate with scientific instruments and other peripherals.

CP/M*2.2

CP/M* is also available making a wide range of packages immediately available including wordprocessing, financial modelling, data base management to mention but a few. CP/M* also increases the disk capacity to 680K.

(CP/M* is a Trade Mark of Digital Research Ltd).

SHARP
First, and foremost

SHARP ELECTRONICS (UK) LTD., COMPUTER DIVISION,
SHARP HOUSE, THORP RD., NEWTON HEATH,
MANCHESTER M10 9BE. TELEPHONE: 061-205 2333.

Why on Earth don't you find out more?



Please send me full information on the Sharp MZ80B computer.

PC 12/81

Name _____

Address _____

Tel: _____

To: Sharp Electronics (UK) Ltd., Computer Division,
Sharp House, Thorp Road, Newton Heath,
Manchester M10 9BE. Telephone 061-205 2333.

● Circle No. 170

The Sorcerer's Apprentices

- Z80 CPU
- NUMERIC KEY PAD
- 48K MEMORY
- RS 232 PORT
- PARALLEL PORT
- PROGRAMMABLE GRAPHIC CHARACTERS
- FULL ASC II CHARACTER SET including lower case
- S100 COMPATIBLE
- ROM BASIC
- CASSETTE INTERFACE

SORCERER Standard System	APPLE II Standard System	PET 4000 series	TRS 80 LEVEL II with Expansion Interface
↓			↓
↓		↓	↓
↓	↓		↓
↓			↓
↓			
↓		↓	
↓			
↓	↓	↓	↓
↓	↓	↓	↓

Price for 48K with Parallel Port and Disk capacity over 300K **£1,494**

(32K only) **£1,623**

(Disk capacity 150K only) **£1,525**

£1,535

LIVEPORT
DATA PRODUCTS

The Ivory Works, St. Ives, Cornwall TR26 2HF
Telephone: (0736) 798157

Please send me details of Exidy Computer Systems.

Name _____

Address _____

Tel. No. _____



Apple Turnover.

**New Accounting Programs for Apple.
Of very advanced design.
From Computer Arts.**

**Investigate Apple.
Examine other accounting systems.
Then ask to see a Turnover.**

**Sales Ledger
Purchases Ledger
General Ledger**

Designed for small and medium size businesses. And for staff who will be using a computer for the first time in their life. We've put a lot of thought into making everything straightforward. With no loss of accountancy standards.

**Treat your staff to an Apple Turnover.
And yourself to the benefits of computer accounting.
You all deserve it.**

**Computer Arts Limited. 11, London Street, Reading, Berkshire. RG1 4PN
Telephone: Reading (0734) 54451.**

Computer Arts provides a full backup service including consultancy, training and permanently manned Customer Service Desk. The Turnover system is available through any Apple dealer. Contact us directly if you have any difficulty getting a demonstration. Price of £444 per ledger includes a full kit containing all the disks needed, disk storage cases, printer stationery, report binders and printed identification labels. Comprehensive instruction book and practice disk minimize need for any special training. No special equipment or extras of any kind needed beyond a standard Apple computer system.

Apple and the Apple symbol are the registered trademarks of Apple Computer Inc, Cupertino, CA, USA.

THE **MICROPUTE** CHALLENGE:— FIND A COMPUTER TO COMPARE WITH THE *Sig/net* ... NEVER.



... Because the SIG/NET offers the price advantage of the low cost systems together with the flexibility and infinite expansion capabilities of the high cost systems.

Or in other words a great deal more for a great deal less.

For just **£1,299.00** the standard SIG/NET offers the flexibility to choose the terminal best suited to your requirements, the printer to give the speed and quality you need and disk capacity from 400,000 to 40 Million characters.

The standard SIG/NET 202S	£1,299.00
5 Megabyte hard disk system	£3,100.00
10 Megabyte 4 User	£6,000.00
10 Megabyte 10 User	£9,500.00

FOR FURTHER TECHNICAL DATA AND THE NAME OF YOUR NEAREST DEALER SEND THE COUPON **NOW!**

MICROPUTE
Catherine Street, Macclesfield, Cheshire, SK11 6QY. Tel: (0625) 612759.

NAME _____ POSITION _____

COMPANY NAME _____

COMPANY ADDRESS _____

_____ TEL. NO _____

Dealer enquiries invited for certain areas of the Midlands and North.

● Circle No. 173

THERE'S JUST NONE TO COMPARE.

- Unbeatable value for money.
- Advanced and innovative **BRITISH** design.
- **BRITISH BUILT.**
- Unrivalled expansion.
- Faster than comparable systems.
- Full 64K of memory.
- Sold only through approved dealers.
- CP/M compatible.



microcomputer systems

Catherine Street,
Macclesfield,
Cheshire,
SK11 6QY.
Tel: (0625) 612759.

Tennis and interface

THIS GAME has been written in Basic for the Nascom 2 computer, but it should be relatively easy to modify for use on other computers with similar graphics facilities, writes Adrian Dickens of Cambridge. My original version produced sound effects whenever the ball bounced off the bats or a wall. I have put Rem statements by all of the instructions related to the generation of sound, so that the routines can be modified, or if necessary removed from the program.

My sound effects were simply a constant tone with an envelope on the amplitude. This simulates the sound produced by conventional TV games very well. I used a home-brew sound generator with an AY-3-8910 sound chip.

The machine-code subroutine is used to take a character from the keyboard while the program is running. The character codes from the Nascom keyboard cursor keys are 17,18,19,20. These give each of the two players an up and a down key to control the movements of their bats. The aim of the game is to stop as many balls from passing by the bat as possible.

If a ball does go by one player's end, his opponent's score is incremented by one. When the game is initially run, the relative speed of play for each player can be assigned. Play starts when a ball appears at random in the court, moving in a random direction.

The second program, which is an interface between the Nascom 2 and the Epson printer, comprises three routines, designed to be used together. The major

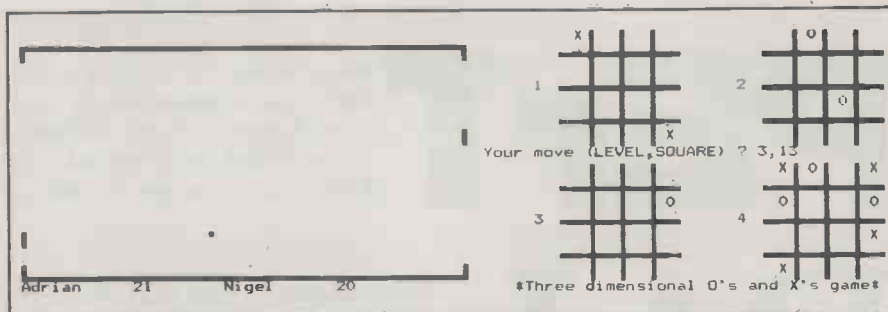

Sample printouts of tennis and noughts and crosses.

advantage of this printer interface with the Nascom is that all of the Nascom block graphics are printed. As anyone who has already bought an Epson printer will realise, while all of the block-graphic characters produced by the Nascom can also be produced by the Epson, the character codes are not compatible.

I carefully analysed the two graphics sets, and found that Nascom graphic codes could be converted into Epson codes by changing four bits, using the look-up table, and using a few more instructions to convert the remaining high-order bits.

This method of conversion is considerably better than using a look-up table for all of the block graphics, because it uses up far less memory space. The successful results of the programs can be seen in the sample printouts, one from the computer tennis game, and the other from my three-dimensional noughts and crosses game.

The first routine, Init, must always be called before either of the other routines. This routine sets up the parallel I/O ports

into the correct modes. The printer should be connected to the Nascom as directed in the source listing. Init also loads the address of Out into Nas-Sys workspace, so that output can be directed to the printer by the Nas-Sys "U" command.

Routine Out is used to output the byte stored in the A register to the printer. If a block-graphics character is encountered, it is converted to the Epson code before printing. If one of the Nascom special graphics characters is encountered, a space is printed so that the relevant character can be filled in by hand later if required.

Routine Dump is especially useful for use with Basic, because it enables an exact copy of the Nascom screen to be down loaded on to paper. Both of the printouts from my games were produced using this routine. To use this routine, put the address of Dump into memory at 1004H — low byte — and 1005H — high byte — and enter X = USR(0) under Basic. The printer will then print out an exact copy of the Nascom screen.

Computertennis: Adrian Dickens' program.

```

10 REM*****
20 REM
30 REM  COMPUTER TENNIS GAME FOR THE NASCOM 2
40 REM
50 REM          by A C Dickens
60 REM
70 REM          Copyright September 1981
80 REM
90 REM*****
100 CLS
110 X=A=B=A1=B1=0
120 REM INITIALISE SOUND GENERATOR:GOSUB11031
130 PRINT"***** COMPUTENNIS CHAMPIONSHIPS *****"
140 PRINT
150 PRINT"Each player has control of a racket."
160 PRINT"This is moved up & down with the ";
170 PRINT"cursor keys "
180 PRINT
190 INPUT"Name of player 1 ";N1$
200 PRINT"Speed for ";N1$;" 0 is fastest ";
210 INPUTS1
220 PRINT
230 INPUT"Name of player 2 ";N2$
240 PRINT"Speed for ";N2$;" 0 is fastest ";
250 INPUTS2
260 H1=7:H2=7
270 C1$=CHR$(199):C2$=CHR$(248)
280 CLS
290 FORX=4TO91
300 SET(X,0):SET(X,41):NEXTX
310 FORX=4TO91STEP87
320 SET(X,1):SET(X,2):SET(X,39):SET(X,40)
330 NEXTX
340 SCREEN3,15:PRINTN1$;
350 SCREEN23,15:PRINTN2$;
360 REM THIS SETS UP THE USR FUNCTION SO THAT
370 REM CHARACTERS CAN BE INPUT FROM THE
380 REM KEYBOARD WITHOUT TEMPORARILY HALTING
390 REM EXECUTION OF PROGRAM.THE USR FUNCTION
400 REM OPERATES LIKE GET$ ON OTHER COMPUTERS.
410 DOKE3200,25311
420 DOKE3202,312
430 DOKE3204,18351
440 DOKE3206,10927
450 DOKE3208,-8179
460 POKE3210,233
470 DOKE4100,3200
480 REM Main loop
490 X=21-USR(0)
500 ONXGOSUB 560,600,640,680
510 GOSUB720
520 GOSUB830
530 GOSUB920
540 GOSUB960
550 GOTO480
560 SCREEN46,H2:PRINT " "
570 IFH2<13THENH2=H2+1
580 SCREEN46,H2:PRINTC2$
590 RETURN
600 SCREEN3,H1:PRINT " "
610 IFH1>2THENH1=H1-1
620 SCREEN3,H1:PRINTC1$
630 RETURN
640 SCREEN46,H2:PRINT " "
650 IFH2>2THENH2=H2-1
660 SCREEN46,H2:PRINTC2$
670 RETURN
680 SCREEN3,H1:PRINT " "
690 IFH1<13THENH1=H1+1
700 SCREEN3,H1:PRINTC1$
710 RETURN
720 IFS=1 THENRETURN
730 D=RND(0)*1000
740 FORE=0TOD:NEXT
750 A=INT(RND(0)*40)+1

```

(continued on page 127)

PERt

Program for PETs. 1200 activities under 400 cost codes. Keyboard entered networks give a critical path, fixed & free float and earliest/latest start/finish times. Reports can be screened or printed. Activity costing and targeting included. £205

DAI

Personal Computer with real world expansion. 16 colour graphics with sound. Stereo output. Socket for printer on RS232 port. The machine has 48K and a thriving user group is providing software. £595

S100

We can supply a host of S100 cards. (including RTCs, A/D, battery memories & graphics application) floppy discs & connectors.

MAT-8 DAISY RIX & WHEEL

Novel Image 800 Does everything a £799 matrix printer should do and then lets you fit a daisy wheel too.

CODIFIED
COMPUTER
SYSTEMS

15 Newington Green,
London. N16.
Tel: 01-254 7419

● Circle No. 174

APPLE II AND ITT 2020

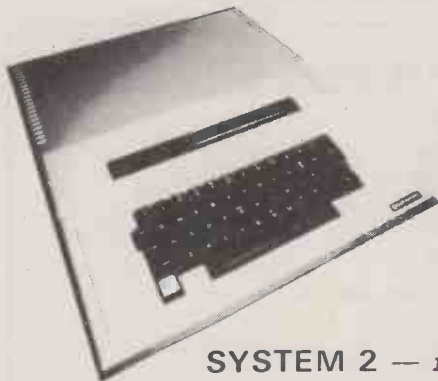

SYSTEM 2 — £999

- * ITT 2020 - 48K
- * DISK DRIVE WITH CONTROLLER
- * DISK DRIVE WITHOUT CONTROLLER
- * RAMEX 16 EXPANSION BOARD
- * THE MANAGER

The Manager organises your computer memory to make available an extra 10.5K of RAM by locating the Disk Operation System onto the RAMEX 16 which can be located into any convenient slot apart from 0.

- £999 Does not include VAT or Delivery which will be charged for by area.
- All major credit cards are accepted and goods are normally despatched in 48 hours.

This month we are able to offer the first time user two packages. These two offers are made as Mail Order Starter Packs to encourage the potential first time Microcomputer user to take the first step into the Microprocessor Revolution. When you have taken delivery of your Starter System come back and talk to us about your particular application and other devices that will enhance your system and make it work for you.

SYSTEM 1 — £999

- * APPLE II 'PLUS' - 48K
- * DISK DRIVE WITH CONTROLLER
- * RAMEX 16 EXPANSION BOARD
- * THE MANAGER



In a Class of Their Own.



DDP Research & Marketing
17 Nobel Sq., Basildon, Essex. SS13 1LP.
Tel. Basildon (0268) 728484

● Circle No. 175

(continued from page 125)

```

760 B=42
770 A1=INT(RND(2)*5)-2
780 B1=1
790 IFRND(5)<.5THENB1=-1
800 IFABS(A1)<2THENB1=B1*2
810 S=1
820 RETURN
830 IFA>2AND<39AND<6AND<89THENRETURN
840 IFA=1THEN A1=ABS(A1):REM#SOUND#:GOSUB8000
850 IFA=2AND A1=-2THEN A1=ABS(A1):REM#SOUND#:GOSUB1160
860 IFA=40THEN A1=-ABS(A1):REM#SOUND#:GOSUB1160
870 IFA=39AND A1=2THEN A1=-ABS(A1):REM#SOUND#:GOSUB1160
880 IFB<6OR B>89THEN B1=-B1:RETURN
890 IFB=6AND ABS(B1)=2THEN B1=B1/2:RETURN
900 IFB=89AND ABS(B1)=2THEN B1=B1/2:RETURN
910 RETURN
920 RESET(B,A):A=A+A1:B=B+B1:SET(B,A)
930 IFB1=-1OR B1=-2THEN 950
940 FORX=0TOS2:NEXT:RETURN
950 FORX=0TOS1:NEXT:RETURN
960 JFB>5AND<90THENRETURN
970 IFB=5AND H1=INT(A/3+1)THEN 1100
980 IFB=90AND H2=INT(A/3+1)THEN 1100
990 Z=0
1000 IFA=10RA=20RA=39ORA=40THEN Z=1
1010 REM #SOUND#:GOSUB8000
1020 IFZ=1THEN A1=INT(RND(2)*5-2)
1030 IFZ=1THEN RETURN
1040 RESET(B,A)

```

```

1050 IFB=5THEN C2=C2+1
1060 IFB=90THEN C1=C1+1
1070 SCREEN13,15:PRINTC1;
1080 SCREEN33,15:PRINTC2;:S=0
1090 RETURN
1100 REM BALL REBOUNDS FROM BAT SOUND:GOSUB17000
1110 A1=INT(RND(7)*5-2)
1120 IFABS(A1)<2THEN H=1
1130 IFH=1AND ABS(B1)=1THEN B1=B1*2
1140 H=0
1150 RETURN
1160 REM REBOUND OFF SIDE 'WALLS' SOUND
1170 IF(A=10RA=40)AND A1=0THEN RETURN
1180 POKEA2,0:POKED2,240
1190 POKEA2,13:POKED2,0
1200 RETURN
1210 REM THE NEXT 4 LINES INITIALISE MY SOUND
1220 REM GENERATOR.
1230 A2=-28608:D2=-28607
1240 POKEA2,7:POKED2,254
1250 POKEA2,12:POKED2,9
1260 POKEA2,8:POKED2,16
1270 RETURN
1280 REM BALL OFF BATS SOUND
1290 POKEA2,0
1300 IFB=5THEN POKED2,255
1310 IFB=90THEN POKED2,225
1320 POKEA2,13:POKED2,0
1330 RETURN
Ok

```

The Nascom 2 to Epson printer interface.

ZEAP Z80 Assembler - Source Listing

```

0010 ;*****
0020 ;
0030 ; EPSON MX80 PRINTER INTERFACE WITH
0040 ; A NASCOM 2 MICROCOMPUTER.
0050 ;
0060 ; Copyright by A.C.Dickens
0070 ; September 1981
0080 ;
0090 ;*****
0100 ;Connections to the Nascom 2 I/O ports
0110 ;
0120 ;B0 - B7 to printer DATA IN lines D0 - D7
0130 ;A0 to printer BUSY line
0140 ;A1 to printer STROBE line
0150 ;A2 to printer INITIALISE line
0160 ;
0170 ;Routine INIT sets up the Nascom ports for
0180 ;use with the EPSON, and selects routine
0190 ;OUT for use with NAS-SYS user output
0200 ;option. The printer is turned ON by the
0210 ;'U' command in NAS-SYS, and turned OFF by
0220 ;the 'N' command.
0230 ;SET UP PORT B FOR BYTE OUTPUT
8000 0240 ORG 0B000H
8000 3E0F 0250 INIT LD A,15
8002 D307 0260 OUT (7),A
0270 ;SET UP PORT A
0280 ;A0 = BUSY
0290 ;A1 = STROBE
0300 ;A2 = INITIALISE
8004 3EFF 0310 LD A,FFH
8006 D306 0320 OUT (6),A
8008 D304 0330 OUT (4),A
800A 3EF9 0340 LD A,EF9H
800C D306 0350 OUT (6),A
800E 211580 0360 LD HL,OUT;SET USER OUTPUT ADDRESS
8011 22780C 0370 LD (0C7BH),HL;FOR USE BY NAS-SYS
8014 C9 0380 RET
0390 ;PRINTER OUTPUT ROUTINE
0400 ;CHARACTER FOR PRINTING IS IN A REGISTER
8015 F5 0410 OUT PUSH AF
0420 ;TEST FOR A GRAPHICS CHARACTER
8016 CB7F 0430 BIT 7,A
8018 2B1E 0440 JR Z,PRINT
0450 ;SELECT BLOCK GRAPHICS ONLY
0460 ;PRINT A SPACE IF IT IS NOT A BLOCK
801A CB77 0470 BIT 6,A
801C 2004 0480 JR NZ,GRAPHIC
801E 3E20 0490 LD A,32;SPACE CODE
8020 1816 0500 JR PRINT
0510 ;CORRECT BITS 5 & 6 OF THE CODE FOR EPSON
8022 D620 0520 GRAPHIC SUB 32
8024 4F 0530 LD C,A
0540 ;CORRECT BITS 1,2,3,4 OF CODE FOR EPSON
8025 E61E 0550 AND 1EH
8027 CB3F 0560 SRL A
8029 114A80 0570 LD DE,TABLE
802C 8B 0580 ADC A,E
802D 5F 0590 LD E,A
802E 7A 0600 LD A,D
802F CE00 0610 ADC A,0
8031 57 0620 LD D,A
8032 1A 0630 LD A,(DE)
8033 57 0640 LD D,A
8034 79 0650 LD A,C
8035 E6E1 0660 AND 0E1H ;1110 0001
8037 B2 0670 OR D
0680 ;GRAPHICS CODE NOW CONVERTED FOR PRINTING
0690 ;LOAD CHARACTER TO BE PRINTED ONTO PORT
803B D305 0700 PRINT OUT (5),A
0710 ;WAIT UNTIL THE BUSY LINE GOES LOW
803A DB04 0720 LOOP IN A,(4)
803C CB47 0730 BIT 0,A
803E 20FA 0740 JR NZ,LOOP
0750 ;STROBE DATA INTO PRINTER
8040 3EFD 0760 LD A,FFD
8042 D304 0770 OUT (4),A
8044 3EFF 0780 LD A,FFF
8046 D304 0790 OUT (4),A
8048 F1 0800 END POP AF
8049 C9 0810 RET
0820 ;TABLE FOR GRAPHICS CONVERSION
804A 00 0830 TABLE DEFB 00H
804B 04 0840 DEFB 04H
804C 10 0850 DEFB 10H
804D 14 0860 DEFB 14H
804E 02 0870 DEFB 02H
804F 06 0880 DEFB 06H
8050 12 0890 DEFB 12H
8051 16 0900 DEFB 16H
8052 08 0910 DEFB 08H
8053 0C 0920 DEFB 0CH
8054 18 0930 DEFB 18H
8055 1C 0940 DEFB 1CH
8056 0A 0950 DEFB 0AH
8057 0E 0960 DEFB 0EH
8058 1A 0970 DEFB 1AH
8059 1E 0980 DEFB 1EH
0990 ;END OF TABLE
1000 ;ROUTINE DUMP PRINTS OUT AN EXACT COPY OF
1010 ;THE NASCOM SCREEN, EXCEPT FOR SPECIAL
1020 ;GRAPHICS CHARACTERS, WHICH ARE PRINTED AS
1030 ;BLOCK GRAPHICS.
1040 ;LOAD HL WITH START POSITION ON SCREEN
805A 210A0B 1050 DUMP LD HL,0B0AH
1060 ;SET THE LINE LENGTH TO 48 CHARACTERS
805D 0630 1070 LINE LD B,30H
1080 ;GET CHARACTER IN A REGISTER
805F 7E 1090 COLUM LD A,(HL)
1100 ;PRINT THE CHARACTER
8060 CD1580 1110 CALL OUT
8063 23 1120 INC HL
1130 ;HL NOW POINTS TO NEXT SCREEN POSITION
8064 10F9 1140 DJNZ COLUM
8066 111000 1150 LD DE,10H
8069 19 1160 ADD HL,DE
1170 ;DO A CARRIAGE RETURN
806A 3E0D 1180 LD A,13
806C CD1580 1190 CALL OUT
1200 ;DO A LINE FEED
806F 3E0A 1210 LD A,0AH
8071 CD1580 1220 CALL OUT
1230 ;LAST LINE ?
8074 7C 1240 LD A,H
8075 FE0C 1250 CP 0CH
8077 20E4 1260 JR NZ,LINE *
8079 C9 1270 RET
1280 ;THE END

```

Subtle Scroll Stopper

I WAS interested by Scroll Stopper in the July 6502 Special as I have been using a similar program for some time now, writes Derek Aston of Spennymoor, County Durham. I am sending you my version, as there is a subtle difference between the two.

I have found the program so useful that I have managed to patch it into my Mon02 Monitor ROM by shortening the start-up message. There is also a dis-assembly from my monitor for the benefit of anyone with PROM programming facilities.

Scroll Stopper

```
10 REM Controlled LIST for UK101 by D.Aston
12 :
14 REM for UK101, Mon02
16 REM Program resides at HEX 029B to 02BA
19 REM TO INVOKE, POKE 541,2
20 REM TO DISABLE, POKE 541,255
22 REM TO LIST, type LIST, hit RETURN
24 REM then push SPACE BAR
26 REM To Quit LIST command, hit 'Q'
28 REM TO EDIT, enter LINE NUMBER, hit RETURN
30 REM then push SPACE BAR
32 :
34 REM for UK101, Mon01
36 REM Program resides at HEX 0269 to 02B8
38 REM Change 155 in line No.34 to 105
40 REM Change 667 in line No.36 to 617
42 REM TO INVOKE, POKE 539,2
44 REM TO DISABLE, POKE 539,255
46 :
48 DATA173,5,2,208,20,165,19,201,153
50 DATA208,14,169,253,141,0,223,173,0
```

```
52 DATA223,73,255,240,244,48,3,76
54 DATA153,255,24,76,79,166
56 A=667;FORN=0T031;READD;POKEA+N,D;NEXT
```

Monitor disassembly

```
FEF4 7F ;Was 9B Re-route Control C
FEF5 FC ;Was FF Vector on RESET

FC78 20 ; Start-up message
FC79 4D 'M
FC7A 2C 'C
FC7B 43 'C
FC7C 2C 'C
FC7D 57 'W
FC7E 00 ;Message terminator
FC7F AD0502 LDA #0205 ;Test SAVE FLAG
FC82 D019 BNE #FC9D
FC84 AD1102 LDA #0211 ;Test PRINTER FLAG
FC87 D014 BNE #FC9D
FC89 A513 LDA #13 ;Was last
FC8B C999 CMP #99 ;command LIST
FC8D D00E BNE #FC9D
FC8F A9FD LDA #9F ;Mask Keyboard
FC91 B000DF STA #0F00 ;Get Keyboard
FC94 AD00DF LDA #0F00 ;Complement
FC97 49FF EOR #FF
FC99 F0F4 BEQ #FCBF ;Wait for command
FC9B 3003 BMI #FCA0 ;Quit
FC9D 4C9BFF JMP #FF9B ;Continue Listing
FCA0 18 CLC
FCA1 4C4FA6 JMP #A64F ;Abort LIST command
```

Spreading Life

THE GAME of Life is a mathematical simulation of the evolution of a colony of cells, writes Simon Cogle of Carshalton, Surrey. In this version, the grid is 32 cells by 16 cells with wrap-round at all edges. Each cell is either white — indicating maturity — grey — indicating new-born

— or black — indicating empty. The rules for deriving the next generation are:

- A mature cell with less than two mature neighbours dies of loneliness.
- A mature cell with more than three mature neighbours dies of overcrowding.
- A cell is born in an empty cell if it is adjacent to exactly three mature neighbours.

This program produces the next generation in two stages. New cells are born, then some of the mature cells die and the new-born cells mature. The program begins in Input mode. You may input your colony of cells using the following keys: ↑, move cursor up; ↓, move cursor down; →, move cursor right; ←, move cursor left; space, to kill a live cell; and copy, to create a live cell.

Once you have entered your colony, key "R" and the program begins generating new colonies based on the rules. Each generation takes about 1.5 seconds — including a one-second wait.

While the program is in Run mode you may use the following keys: Control, to make the program pause at the end of the current generation; Shift, to resume after Control is used; and Repeat, to return to Input mode, e.g., to amend the colony.

The Break or Escape key may be used to exit from the program at any time.

The program uses direct cursor addressing — DE₁₆ and DF₁₆ contain the cursor row and EO₁₆ contains the cursor column.

You will soon discover that a colony need not be large to produce interesting results. For example, the pattern I call the spinner, because it produces an intermediate which is a twisted version of the original, is only five cells:

X		
X		X
X	X	

The spinner moves diagonally across the grid at a speed of one-quarter, i.e., a one-cell movement every four generations. This is the fastest moving group I have found so far, can you find a flyer?

Atom fractions

THIS PROGRAM for the Acorn Atom enables it to calculate fractions, writes Brian Lloyd of Witham, Essex. It will cancel down, add, subtract, divide and multiply pairs of fractions.

```
10 REM LIFE V5.1
15 DIM KK(5),K(0)
20 G=#A0;B=#FF;D=#20;E=#7F;S=#8000;F=0
21P.*21;FOR J=0 TO 1;DIM P(-1)
22L.;KKO LDY @#3B;CLC;LDA @#20;LDX @10;BIT #B001;BEQ P+10
23 INC #B000;DEY;DEX;BNE P-10;LSRA;PHP;PHA;LDA #B000
24 AND @#F0;STA #B000;PLA;PLP;BNE P-27;STY K1RTS;
25;KK1 LDA @31;STA #B01;KK2 LDA @15;STA #B1;KK3 LDX @0
26 LDA @31;STA #B3;KK4 LDA @15;STA #B4;KK5 LDA @B0;STA #B6
27 LDA #B1;CLC;ADC #B4;AND @#F;ASLA;ASLA;ASLA;ASLA
28 BCC P+4;INC #B6;STA #B5
29 LDA #B0;CLC;ADC #B3;AND @#1F;TAY
30 LDA @G;CMP (#B5),Y;BNE P+3;INX
31 LDA @E;CMP (#B5),Y;BNE P+3;INX
32 INC #B4;LDA #B4;CMP @1B;BNE KK5
33 INC #B3;LDA #B3;CMP @34;BNE KK4
34 LDA @#B0;STA #B6
35 LDA #B1;ASLA;ASLA;ASLA;ASLA;ASLA
36 BCC P+4;INC #B6;STA #B5;LDY #B0
37 LDA @D;CMP (#B5),Y;BNE P+10;CPX @3;BNE P+6;LDA @B
38 STA (#B5),Y
39 LDA @G;CMP (#B5),Y;BNE P+14;CPX @3;BEQ P+10;CPX @4;BEQ P+6
40 LDA @E;STA (#B5),Y
41 DEC #B1;BPL KK3;DEC #B0;BMI P+5;JMP KK2
46 RTS;J
47 NEXT J;P.*6,*12
48JLINK KKO
49 Z=#DE3;#FFF;?#EO
50 IF ?K=4 P.*11
60 IF ?K=7 AND Z<#B1E0 THEN P.*10
70 IF ?K=5 P.*8
75 IF Z=#B1FF GOTD n
80 IF ?K=6 P.*9
90 IF ?K=0 P.*5D
100 IF ?K=14 P.*#B0
110nIF ?K<50 GOTD j
120 ?Z=?Z:#B0
130gFOR J=1 TO 60;WAIT;NEXT J
140 LINK KK1
270 FOR Q=#8000 TO #B1FF
280 ?D=?D@B
290 NEXT Q
300wIF ?#B002&#40=0 THEN ?#E1=0;P.*30;?#E1=#B0;?S=?S:#B0;G.J
310 IF ?#B001&#40=0 F=1
320 IF ?#B001&#B0=0 F=0
330 IF F GOTD w
340 GOTD g
```

```
5 REM "FRACTIONS"
10 IN.A;IN.B;IN.C;IN.D
20 G.2010
30 P."1=ADD";P."2=MINUS";P."3=DIVIDE";P."4=MULTIPLY"
40 IN.G
50 IF G=1 G.100
60 IF G=2 G.200
70 IF G=3 G.400
80 IF G=4 G.500
100 F=A+C;G=B
110 P.*12;P.F';P." ----";P.G
115 IF G<F GOS.3000
120 G.10
200 F=A-C;G=B
210 P.*12;P.F';P." ----";P.G
215 IF G<F GOS.3000
220 G.10
400 F=A*B;G=B*C
```

```
410 P.*12;P.F';P." ----";P.G
415 IF G<F GOS.3000
420 G.10
500 F=A*C;G=B*B
510 P.*12;P.F';P." ----";P.G
515 IF G<F GOS.3000
520 G.10
2000 END
2010 IF B<>D A=A*D
2020 IF B<>D C=C*B
2030 IF B<>D B=B*D
2040 P.A" OVER "B";P.C" OVER "B"
2050 G.30
3000 P.*12;P.F/G;P." AND ";P.F%G;P."
3050 P." ----"
3060 P.G'
3100 R.
```

0 to 60^{ch's} in one second



THE RICOH 1600S

If it's high performance you're looking for, the Ricoh 1600S is for you, offering an amazing 60 characters in just 1 second. An updated version of the tried-and-tested 1600, the new S model has been re-designed and fitted with all sorts of extras. Yet one thing hasn't changed — the price, making the 1600S cheaper than any equivalent model on the market. This superb performer incorporates the Z80 micro-processor, auto bidirectional printing and look-ahead logic, increasing speed and efficiency. Other capabilities include proportional spacing, graph plotting and word processing enhancements. The printer includes a standard centronics interface, and RS232 and IEEE options are available.

The Ricoh 1600S is available only from Micropute and their authorised dealers, all backed up with a nationwide service network. If you're interested in the 1600S either as a customer or as a dealer, send the coupon now.

Picture shows 1600s fitted with tractor feed option

Please send me details on the Ricoh 1600S.

Name _____
Position _____
Company _____
Address _____

Tel. No

**RICOH 1600S THE PERFORMANCE HAS
RISEN — THE PRICE HASN'T**

FEATURES COMPETITORS

	DIABLO 630	QUME SPRINT 5	SPIN- WRITER	RICOH RP.1600 (10 DATA)	RICOH RP.1600S
PRINT SPEED (CPS)	40	45/55	55	60	60
PRINT ELEMENT	DAISY- WHEEL	DAISY- WHEEL	THIMBLE	DOUBLE DAISY- WHEEL	DOUBLE DAISY- WHEEL
AUTO BIDIRECTIONAL	Yes	No	No	No	Yes
AUTO LOGIC SEEKING	Yes	No	Yes	No	Yes
PROPORTIONAL PRINT CAPABILITY	Yes	Yes	Yes	No	Yes
EXTENDED CHARACTER SET	No	No	Yes	Yes	Yes
LETTER QUALITY PRINT	Yes	Yes	Yes	Yes	Yes
CUSTOM INTER- FACE OPTION	No	No	No	No	Yes
PRICE	£1675	£1950	£1950	£1450	£1450

The above information was gathered from distributors and abstracted from their current literature. Prices shown are those advertised at the present time.

MICROPUTE
microcomputer systems

Catherine Street, Macclesfield, Cheshire.
SK11 6QY. Tel: Macclesfield 612759

● Circle No. 176

Accounting
Business Systems

TABS

Low cost, fully integrated, modular accounting business systems.

To meet the ever increasing demand for greater business efficiency the microcomputer is now considered vital in the quest to maximise profitability.

TABS, recognising the need for a simple, low cost accounting business system have developed unique, fully integrated modules for the APPLE II and PET microcomputers which will shortly be available on CP/M based machines.

The modules are also designed to be flexible so that whether you run a small manufacturing company or a small retail outlet, each one may be adapted to meet your individual requirements exactly.

TABS two new multi-user systems now enable up to 16 separate terminals to be used simultaneously.

With over 5000 modules already installed, TABS is rapidly becoming the number one choice for accounting business systems.

Remember, TABS accounting business systems, the red and black way to increase your profits.

Available through our national dealer network or from TABS Ltd, Sopers House, Chantry Way, Andover, Hampshire SP10 1PE.

Come to one of our
Free Exhibition Days
(No invitation required)

Edinburgh 29th Sept, 27th Oct
Royal Scot Hotel
031-334-9191

Manchester 30th Sept, 28th Oct
Grand Hotel, Portland Suite
061-236-9559

London 1st Oct, 29th Oct
Park Court Hotel, Lancaster
Gate 01-402-4272

Bristol 2nd Oct, 30th Oct
Unicorn Hotel,
Prince Street
0272-28055

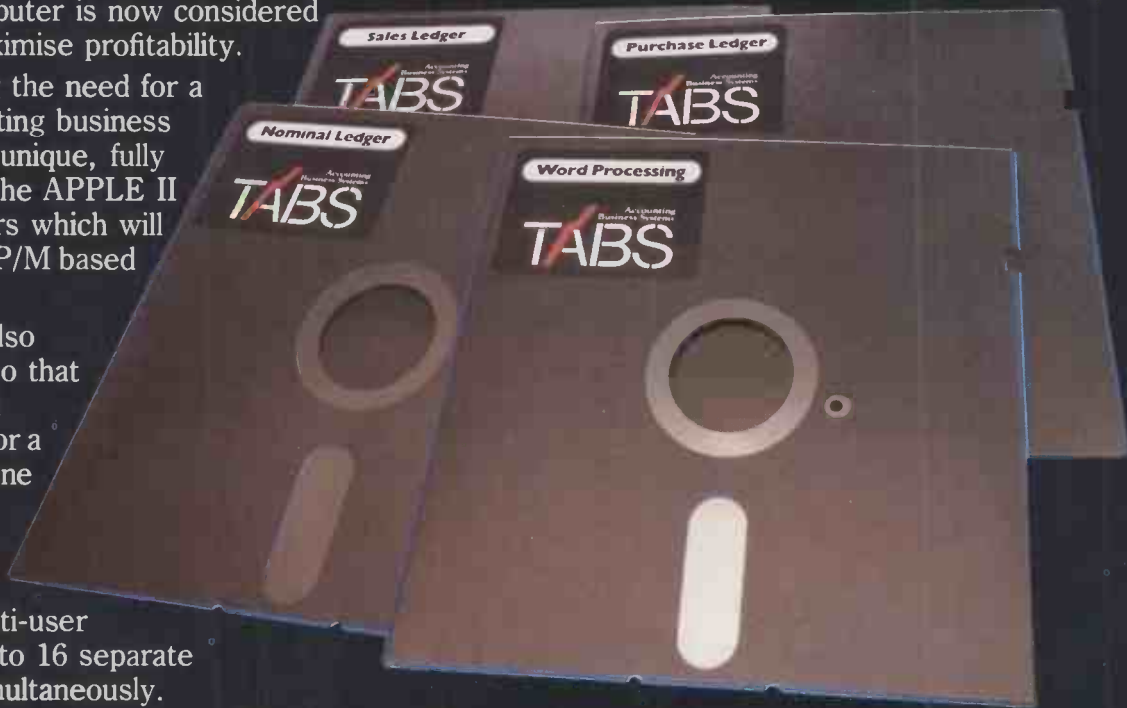

Small System: Apple 48K, VDU, Disk with Controller, Disk without Controller, Sales Ledger Module, Silentyper Printer, TABS Firmware Card.
Price from £2,250.
Capacity: 400 Customers, 400 Suppliers, 1000 Stock Items.



Medium System: Apple 48K, Cameo Controller, Ampex 10MB Fixed Disk, Paper Tiger Printer, VDU, TABS Business Software. Price from £6,500
Capacity: Over 2000 Customers, over 2000 Suppliers, over 10,000 Stock Items.

New Feature

TABS now offer a multi user system which enables up to 16 separate terminals to be used simultaneously giving each operative independent access to modules stored on a single hard disk.

A typical 4 user system would cost around £12,000.

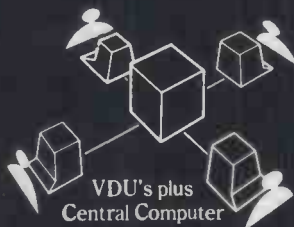

Now available

Video training programmes for each TABS module. Details and price on request.

Modules Include: Purchase Ledger, Sales Ledger, Sales Order Processing, Invoice Compiler, Fast Data Entry, Nominal Ledger, Management Accounts, Job Costing, Payroll, Bill of Materials, Stock Control, Word Processor, Mail List.

£99

Modules from
Installation not included.

If you are interested in TABS low cost Accounting Business Systems, please tick box(es) and return this coupon to us.

User enquiry

- Please send me details about TABS Accounting Systems
- Please send me the TABS User Manual

I enclose £5 (postage and packing included)

Dealer enquiry

- Please send me details of your Dealer Plan

NAME _____

ADDRESS _____

Tel. No. _____

TABS Ltd, Sopers House, Chantry Way, Andover, Hampshire SP10 1PE. Telephone: Andover (0264) 58933

Accounting
Business Systems
TABS

PUT SOME
COLOUR
 INTO YOUR PERSONAL COMPUTING

WITH THE **NEW**

OKI if800
model 20

The **OKI if800** brings a new and colourful dimension to personal computing. Now you can enjoy extensive multicolour graphics facilities and a CP/M* environment on the same machine!

Just look at some of the features and facilities uniquely offered by the new **OKI if800** ... a truly versatile fully integrated computer system!

Features:

- **Powerful Z80A 4MHz Processor.**
- **High resolution multi-colour graphics CRT.**
- **CP/M***
- **Versatile OKI BASIC.**
- **Twin set of programmable function keys.**
- **Integral 80cps OKI printer.**
- **560K bytes mini floppy disks.**

Options:

- **External twin 8 inch floppy disk drives (1M byte).**
- **ROM cartridge.**
- **RS 232C Interface.**
- **Audio cassette.**
- **Light pen.**
- **Centronics parallel interface.**
- **Instrument interface IEEE 488.**
- **Analogue-digital and digital-analogue convertor.**

DISTRIBUTOR AND DEALER ENQUIRIES INVITED.

PRICED AROUND £4,750 (+ VAT)



Copse Road, St. Johns, Woking, Surrey GU34 1SX Telephone: Woking (04862) 23411 Telex: 85952

Please send me full details of **OKI if800** today!

Name:

Company:

Address:

Tel:



Turn your Apple into the world's most versatile personal computer.

The SoftCard™ Solution. SoftCard turns your Apple into two computers. A Z-80 and a 6502. By adding a Z-80 microprocessor and CP/M to your Apple, SoftCard turns your Apple into a CP/M based machine. That means you can access the single largest body of microcomputer software in existence. Two computers in one. And, the advantages of both.

Plug and go. The SoftCard system starts with a Z-80 based circuit card. Just plug it into any slot (except 0) of your Apple. No modifications required. SoftCard supports most of your Apple peripherals, and, in 6502-mode, your Apple is still your Apple.

CP/M for your Apple. You get CP/M on disk with the SoftCard package. It's a powerful and simple-to-use operating system. It supports more software than any other microcomputer operating system. And that's the key to the versatility of the SoftCard/Apple.

BASIC included. A powerful tool, BASIC-80 is included in the SoftCard package. Running under CP/M, ANSI Standard BASIC-80 is the most powerful microcomputer BASIC available. It includes extensive disk I/O statements, error trapping, integer variables, 16-digit precision, extensive EDIT commands and string functions, high and low-res Apple graphics, PRINT USING, CHAIN and COMMON, plus many additional commands. And, it's a BASIC you can compile with Microsoft's BASIC Compiler.

More languages. With SoftCard and CP/M, you can add Microsoft's ANSI Standard COBOL, and FORTRAN, or

Basic Compiler and Assembly Language Development System. All, more powerful tools for your Apple.

Seeing is believing. See the SoftCard in operation at your Microsoft or Apple dealer. We think you'll agree that the SoftCard turns your Apple into the world's most versatile personal computer.

Complete information? It's at your dealer's now. Or, we'll send it to you and include a dealer list. Write us. Call us.

SoftCard is a trademark of Microsoft, Inc. Apple II and Apple II Plus are registered trademarks of Apple Computer, Inc. Z-80 is a registered trademark of Zilog, Inc. CP/M is a registered trademark of Digital Research, Inc.

MICROSOFT
CONSUMER PRODUCTS

Microsoft Consumer Products, 400 108th Ave. N.E.,
Bellevue, WA 98004, U.S.A. (206) 454-1315



Pete & Pam Computers

Waingate Lodge,
Waingate Close,
Rossendale, Lancs, BB4 7SQ
Telephone Rossendale (0706) 227011

● Circle No. 179

Flying ducks

DUCK SHOOT is an interactive graphics game by Simon Williams from Tealby, Lincs. The player tries to pot 10 ducks which flap individually across the screen. They appear randomly to left and right at five different heights, with two ducks at each height in the course of a game.

The player controls the hunter with the keys 1, 2 and 3 which direct the shots left, overhead and right, respectively. A shot is fired by pressing the space bar. When a duck has been hit, a score is displayed which depends on its height and how far it has travelled.

Each score is added to the player's total, which is displayed at the bottom of the screen. When all 10 ducks have flown, the total score is compared with the three best previous scores, and an updated score card is displayed. The game then repeats with another 10 ducks, if required.

The program is written for a TRS-80 with level-2 Basic. It uses no Poke statements and should, therefore, be straightforward to convert to other machines with reasonable graphics capabilities. The graphics characters are loaded into strings in lines 300 to 400 and are Printed at various locations on the screen to obtain the desired effects.

To speed the running of the program, the main sections are listed at the beginning and much use is made of multi-statement lines. A further modification to increase speed would be to remove all Rem statements and spaces in lines 19 to 100.

Printed calendar

A PROGRAM to print out a calendar for any year from 1916 onwards, comes from K C Baldrey of Portsmouth. When Run is entered, the program halts and asks for which year the calendar is to be printed.

Line 15 calculates the number of years' difference. Line 20 calculates the number of leap years. Line 25 calculates the total number of days to be added.

Lines 35 to 42 are a loop based on the maximum number of leap years — 30 — possible before the year 2000 or thereabouts, and calculate the actual number

of days to be added for one week to give the start day for January. Monday is day zero.

When the number is less than seven, the program jumps out of the Z loop to line 60 which reads the month data, ready to start generating the calendar. Line 65 sorts out whether or not it is a leap year, and gives D a value of 29 for February. Lines 75 to 180 generate the calendar format.

Line 185 calculates the start day of the months February to December. It is put in

this position so that the previous month's data D is available for the calculation of S for the present month. Lines 195 to 255 are the month data.

A subroutine at line 1000 is used to generate the lines between weeks, etc., which is needed a large number of times. Line 1020 advances the paper at the end of the calendar ready for tearing.

This program takes leap years into account. It should run, without amendment, on most computer/printer combinations.

```

10 GOTO 290
15 *** DUCK FLIGHT
20 IF DC<1 OR DC>59 PRINT@DR,DC,B$:: GOTO 160
30 B$=B$-1: IF G$=G1$ G$=G2$ ELSE G$=G1$
40 IF PEEK(P+DR+DC+(S-D*3)/2)-136 M=1
50 PRINT@DR,DC,B$:: DC=DC+D: PRINT@DR,DC,G$
60 IF B$=1 GOTO 110
65 *** HUNTER MOVEMENT AND SHOOT
70 IS=INKEYS: I=VAL(I$): IF I>0 AND I<4 PRINT@796,H$(I):: S=D-66-1
80 IF I$="" AND S=0 S=M-SD: S=S26-SD: PRINT@5,5$:: GOTO 20
90 IF S=D GOTO 20 ELSE IF S<45 PRINT@5,"": S=0: GOTO 20
100 IF PEEK(P+S-SM)32 PRINT@5,"": S=S-SM: PRINT@5,5$:: GOTO 20
105 *** DUCK FALL AND REIRIEVE
110 PRINT@5,"": PI=INT(100-20*DR/64+B$/4): PRINT@DR,DC,"PI "": FOR N=1 TO 500: NEXT
120 TP=IP*PI: PRINT@1014,TP:: PRINT@DR,DC,DF$:: FOR N=1 TO 20: NEXT: DF=DR+DC
130 IF DF<896 PRINT@DF,B$:: DF=DF+SD-1: PRINT@DF,DF$:: FOR N=1 TO 20: NEXT: GOTO 130
140 FOR M=918 TO DF STEP-1: PRINT@M,R2$:: FOR N=1 TO 20: NEXT N,M: S=0
150 FOR M=DF TO 918: PRINT@M,R3$:: FOR N=1 TO 20: NEXT N,M: PRINT@918,R1$
155 *** NEW DUCK
160 IF I=10 GOTO 190 ELSE T=T+1: H=0: D=RND(2)*2-3: B$=59
170 IF D=1 G$=D3$: G2$=D4$: DC=1 ELSE G1$=D1$: G2$=D2$: DC=59
180 R=RND(10): DR=D5(R): IF DR=0 GOTO 180 ELSE DR=DR-64: D5(R)=0: GOTO 20
185 *** END OF GAME AND RERUN
190 GOSUB 480: FOR N=1 TO 11: PRINT: NEXT: PRINT@340,"YOUR SCORE IS"TP*POINTS"
200 IF TP<P(2) PRINT: PRINT TAB(23)"TODAY'S TOP THREE": GOTO 260
210 PRINT TAB(16)"AND IS ONE OF TODAY'S TOP THREE": PRINT
220 PRINT TAB(16)"ENTER YOUR INITIALS (3 MAX)": INPUT T$: PRINT@304,: PRINT
230 IF LEN(T$)>3 THEN T$=LEFT$(T$,3)
240 IF TP>P(0) THEN TP(2)=TP(1): TP(1)=TP(0): TP(0)=IP: T$(2)=T$(1): T$(1)=T$(0): T$(0)=T$: GOTO 260
250 IF TP>P(1) THEN TP(2)=TP(1): TP(1)=TP: T$(2)=T$(1): T$(1)=T$ ELSE TP(2)=IP: T$(2)=T$
260 FOR N=0 TO 2: PRINT TAB(20)N+TAB(30)T$(N)+TAB(40)TP(N): NEXT
270 PRINT: PRINT TAB(20)"PRESS SPACE BAR TO PLAY"
280 IS=INKEYS: IF IS<>" " GOTO 280 ELSE TP=0: T=0: GOTO 410
285 *** INITIALISE
290 CLEAR 100: DEFINT A-Z: P=15360: S$=CHR$(136): B$="*****"
300 D1$=CHR$(131)+CHR$(142)+CHR$(141)+CHR$(129): DIM TP(2),T$(2),H$(3)
310 D2$=CHR$(131)+CHR$(172)+CHR$(156)+CHR$(129)
320 D3$=CHR$(130)+CHR$(142)+CHR$(141)+CHR$(131)
330 D4$=CHR$(130)+CHR$(172)+CHR$(156)+CHR$(131)
340 D5$=CHR$(130)+CHR$(164)+CHR$(156)+CHR$(129)+""
350 H$(1)=CHR$(137)+CHR$(176)+CHR$(188)+CHR$(148)+*****
360 H$(2)=*****+CHR$(190)+CHR$(148)+*****
370 H$(3)=*****+CHR$(188)+CHR$(180)+CHR$(152)+CHR$(129)
380 R1$=*****+CHR$(171)+CHR$(173)+CHR$(152)
390 R2$="*****+CHR$(130)+CHR$(175)+CHR$(140)+CHR$(172)+CHR$(134)+""
400 R3$="*****+CHR$(137)+CHR$(156)+CHR$(140)+CHR$(159)+CHR$(137)+CHR$(148)
405 *** TITLE AND INSTRUCTIONS
410 GOSUB 480: PRINT TAB(19)"COPYRIGHT 1981, S.WILLIAMS": PRINT
420 PRINT *****PRESS SPACE BAR TO SHOOT AT DUCKS. KEYS '1', '2' AND '3'
*****AIM LEFT, OVERHEAD AND RIGHT RESPECTIVELY. EACH DUCK IS1
*****WORTH BETWEEN TWENTY AND ONE HUNDRED POINTS, DEPENDING
*****ON ITS HEIGHT. TEN DUCKS PER GAME. PRESS SPACE BAR"
430 PRINT: PRINT: PRINT
440 IS=INKEYS: IF IS<>" " GOTO 450 ELSE CLS: PRINT@796,H$(2):
450 FOR N=861 TO 864: READ D,D1: PRINT@N,CHR$(D):: PRINT@N+64,CHR$(D1):: NEXT
460 FOR N=960 TO 1022: PRINT@N,CHR$(191):: NEXT: S=D-64
470 PRINT@918,R1$:: PRINT@1000,"POINTS SCORE:"TP:: GOTO 160
480 RESTORE: CLS: FOR N=978 TO 1005: READ D: PRINT@N,CHR$(D):: NEXT: PRINT@960,
490 FOR N=978 TO 1005: READ D: PRINT@N,CHR$(D):: NEXT: PRINT
500 FOR N=1 TO 5: D$(N)=N+64: NEXT: FOR N=6 TO 10: D$(N)=(N-5)*64: NEXT: RETURN
510 DATA 151,131,164,32,32,32,32,32,32,170,32,144,32,32,166,179,147,170,32,32,
32,32,32,32,32,174,132
520 DATA 181,176,134,138,176,154,136,179,179,170,32,144,32,32,176,176,154,170,
131,169,136,179,153,136,179,153,170
530 DATA 171,160,191,149,191,181,129,32

```

```

1 REM *** PROGRAM TO PRINT CALENDAR FOR ANY YEAR FROM 1916 ***
2 REM *** DEVISED BY K.C.BALDREY. ***
3 REM *** 28 th. MARCH 1981 ***
4 REM *** FOR USE ON THE TRS-80 LEVEL 2 MICRO-COMPUTER. ***
5 REM *** IN CONJUNCTION WITH THE EPSON MX 80 PRINTER ***
6 CLS
10 INPUT"ENTER YEAR TO BE PRINTED."Y
15 D=Y-1900
20 L=INT(D/4)
25 S=D+L
35 FOR Z=1 TO 30
40 IF S>=7 THEN S=S-7
42 IF S<7 GOTO 60
45 NEXT Z
60 FOR X=1 TO 12: READ M$,D
65 IF Y/4-INT(Y/4)=0 AND M$="FEBRUARY" THEN D=29
70 GOSUB 1000
75 LPRINT" "M$,TAB(45);Y:TAB(56)"1"
80 GOSUB 1000
85 LPRINT"1 MON I TUE I WED I THU I FRI I SAT I SUN I":
90 GOSUB 1000
95 LET C=0
96 IF S=0 THEN 120
100 FOR K=1 TO S
105 LPRINT"1 "
110 LET C=C+1
115 NEXT K
120 FOR J=1 TO D
125 LPRINT USING"1 ## ";J;
130 LET C=C+1
135 IF C<>7 GOTO 155
140 LPRINT"1"
145 GOSUB 1000
150 LET C=0
155 NEXT J
160 FOR K=1 TO 7-C
165 LPRINT"1 "
170 NEXT K
175 LPRINT"1"
180 GOSUB 1000
185 S=S+D-28: IF S>=7 THEN S=S-7
190 NEXT X
195 GOTO 9999
200 DATAJANUARY,31
205 DATAFEBRUARY,28
210 DATAMARCH,31
215 DATAAPRIL,30
220 DATAMAY,31
225 DATAJUNE,30
230 DATAJULY,31
235 DATAAUGUST,31
240 DATASEPTEMBER,30
245 DATAOCTOBER,31
250 DATANOVEMBER,30
255 DATADECEMBER,31
1000 FOR V=1 TO 57: LPRINT"---";
1005 NEXT V:LPRINT"---";
1010 RETURN
1020 FOR X=1 TO 40 :LPRINT"---":NEXT X
9999 END

```

J. M. Pickard MICRO COMPUTER SERVICES

22 HOLLAND ROAD, CLACTON-ON-SEA, ESSEX CO15 6EQ.
TELEPHONE (0255) 29018.
SALES AND SERVICE

 **apple computer**



VIDEO GENIE



Video Genie System 48K. 2 Disk Drives and 12" green screen monitor, £999.00.

Genie II, system as above, £1100.00.
Apple II Europlus, as above, £1390.00.

Video Genie 16K, £289. 32K, £345.
Genie II 16K, £325.

Apple Silent type Printer, £189.00.
Epson MX80 T Printer, £325.00. MX80 F/T, £355.00.
Monitors, 12" B/W, £65.00. Green Screen, £75.00.

Computer Consumables:
11 x 9.5" continuous plain paper with perforated sprockets, £11.00 per box of 2000 sheets.

Labels 1.44 x 4", 2 across on web, £7.50 per 1000.

Floppy disks: £16.50 per box of 10 (Memorex).
£17.50 per box of 10 (Verbatim).

Don't worry if you can't see what you want ring us and we'll give you a quote.

Plus postage at cost. All items plus VAT.

● Circle No. 180

MACHINE LANGUAGE MADE SIMPLE ZX80 AND ZX81

★ This new book is a must for any **SINCLAIR** user who wants to make full use of his **SINCLAIR ZX80** and **ZX81**. Go beyond Basic into the world of **MACHINE LANGUAGE PROGRAMMING** and open computer horizons you never thought possible! Learn how to use the **SINCLAIR** computer's own language and finally find out what PEEK and POKE is all about!

★ **MORE COMPUTING POWER IN LESS SPACE! FASTER RUNNING PROGRAMS!**

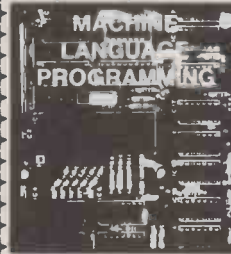

★ Written for the complete beginner as well as for the experienced **SINCLAIR** user, **MACHINE LANGUAGE MADE SIMPLE** has over 120 pages packed with programming techniques, hints and tips.

★ **WRITE YOUR OWN MACHINE LANGUAGE PROGRAMS...**

★ **USEFUL BASIC PROGRAM TO EDIT MACHINE LANGUAGE * COMPLETE DESCRIPTION OF THE INSTRUCTIONS GROUPED BY SUBJECT AND BY USEFULNESS * NUMEROUS SAMPLE MACHINE LANGUAGE ROUTINES DESIGNED SPECIFICALLY FOR THE SINCLAIR 80 & 81 * SIMPLE EASY TO USE LOOK UP TABLES.**

£8.95 (plus 50p p&p)

Please send me copies **MACHINE LANGUAGE MADE SIMPLE FOR YOUR ZX80 & ZX81.**

Orders to: Melbourne House Publishers, 131 Trafalgar Rd, London SE10
Correspondence: Glebe Cottage, Glebe House, Station Rd, Cheddington, Leighton Buzzard, Bedfordshire LU7.
Please enclose cheque or P.O. for £9.45 per copy. Orders outside the UK £9.95.

NAME
ADDRESS PC9/81

● Circle No. 181

FROM THE PUBLISHERS OF THE BEST SELLING BOOKS FOR THE SINCLAIR COMES:

Not Only But Also...
PROGRAMS FOR THE SINCLAIR ZX81...1K

Probably the **LARGEST** range of ZX81 Software in the **WORLD**

Not Only ...does this book contain over 30 fully debugged and exciting programs, every one of which will fit into the basic 1K memory of your Sinclair ZX81 — including programs such as **STAR WARS, LUNAR LANDER, BLACKJACK, MINI ADVENTURE, DRAUGHTS, BREAKOUT.**

But Also

- * Detailed explanation of how these programs were written.
- * Lots of hints on how you can write exciting programs for your ZX81.
- * Numerous space saving techniques — obviously invaluable to the ZX81 owner.
- * **PEEKs** and **POKEs** and all the other 'complicated' functions are clearly explained.
- * **MUCH, MUCH MORE...**



£6.95

£8.95

Understanding Your ZX81 ROM

Plus special section: How to use machine code routines in your BASIC programs. by DR. I. LOGAN.

Dr Logan was the first person to disassemble the Sinclair ZX80 Monitor and was the co-author of the ZX80 COMPANION.

In **UNDERSTANDING YOUR ZX81 ROM** Dr. Logan illustrates all the facilities of the ZX81 Monitor, how it works and how you can use it in your own programs. A special section shows you how you can squeeze more power into your ZX81, by using machine language and machine language subroutines.

An essential book for those who really want to understand the full working of the **SINCLAIR ZX81.**

Published by **MELBOURNE HOUSE PUBLISHERS LTD.**
Send Stamped, self-addressed envelope for **FREE** catalogue.

THE ESSENTIAL SOFTWARE COMPANY (Visconti Ltd)
47 Brunswick Centre, London W1CN 1AF (01-837 3154)

- Please rush me **NOT ONLY 30 PROGRAMS FOR THE SINCLAIR ZX81 1K:** at £6.95 each
- Please also rush **UNDERSTANDING YOUR ZX81 ROM** by Dr. I. Logan at £8.95

I enclose a cheque/postal order for £..... +50p post and pack.
Name
Address

● Circle No. 182

Additional functions

HERE IS a program for the ZX-81 which will imitate the Read, Data, and Restore functions of more powerful computers. writes Stephen Carson-Rowland of Hinckley, Leicestershire.

The data is stored in a Rem statement in exactly the same way as in a proper Data statement, but to distinguish between data and ordinary Rem statements a "□" character CHR\$(8) should be used immediately after the Rem statement, e.g.,

```
10 REM □234,34,456,98,56
```

The data Rems give the best effect if they are at the beginning of the program because they are read more quickly. I usually start the program with

```
1 LET READ=9000
2 LET RESTORE=8000
```

and use Gosub Read and Gosub Restore, because they make the program more understandable. Yet, with only 1K of memory there is little space for the actual program, so subroutine Restore should be deleted, and instead of

```
(line number) GOSUB RESTORE
(line number) LET PC=16509
```

The program is written to accept numerical data, but if string data is required as well, line 9060 should be changed to

```
LET A$=A$+CHR$ PEEK PC,
```

line 9000 to

```
LET A$=""
```

and line 909 deleted. Numerical data can then be taken as well using the Val function. To the best of my knowledge this program will run on a ZX-80 without any modification.

Error bug

I HAVE found what I believe to be a bug in ZX-80 4K Basic, writes D J Crawford of Edinburgh. If this program is run, it yields error code .2/200 which is inconsistent with the program as no line 200 exists.

```
100 IF NOT A=1 THEN GOTO 200
```

A clue to understanding this is given when this program is run:

SUBROUTINE RESTORE

```
8000 LET PC = 16513
8010 RETURN
```

SUBROUTINE READ

```
9000 LET A=0
9010 IF PEEK PC=26 THEN GO TO 9070
9020 IF PEEK PC=234 AND PEEK (PC+1)=8 THEN GO TO 9050
9030 LET PC=PC+1
9040 GO TO 9020
9050 LET PC=PC+2
9060 LET A=A+PEEK PC-28
9070 LET PC=PC+1
9080 IF PEEK PC=118 OR PEEK PC=26 THEN RETURN
9090 LET A=A*10
9100 GO TO 9060
```

```
100 IF A=1 THEN GOTO 200
```

The error code given is 2/100 as one would expect. It would appear that the ZX-80 checks the condition and finds that the undefined A is not equal to 1 and so proceeds and only notices the error once this has been executed.

More memory economy

JOHN BLOXHAM'S memory-saving routine, ZX-80/81 Line-up August 1981, although interesting in itself as a feature of the machine, will not save money, writes Matthew Wright of Sale, Cheshire.

If, instead, one were to enter the following:

```
10 IF 1 = 1 THEN PRINT "20"
20 PRINT "30"
```

then by adopting Eric Deeson's suggestion in the July 1981 edition, one could omit the quotation marks as well. Obviously, the same change will produce the same result.

Big characters

I WAS interested by the program to produce big characters on a 1K ZX-80, printed in ZX-80/81 Line-up on page 119/121 of the September 1981 issue, writes Roy Eastwood, of Romford, Essex.

I have converted the program to run on a 1K ZX-81 and also taken the opportunity to include a machine-code routine to display the characters on the screen, which gives an acceptable speed when run in Slow mode. The program prints the four characters entered in response to the prompt on line 30 eight times normal size.

The program is as follows: first, make space for the 32 bytes of machine code by typing line 10 as follows:

```
10 REM ..... (32 full stops)
```

Then, using the following temporary program, Poke the machine code into the Rem line:

```
20 PRINT AT 21,0;
30 FOR N=16514 TO 16545
40 SCROLL
50 PRINT N;" ";
60 INPUT M
70 POKE N,M
80 PRINT M
90 NEXT M
```

Then type Run, enter the codes followed by the program proper. In response to the prompt, enter any four characters. The characters may be made to appear grey by Poking 8 into address 16532.

(continued on page 136)

Big characters — codes.

At address	enter	meaning
16514	42)
16515	14) LD HL, (16398)
16516	64)
16517	58)
16518	123) LD A, (16507)
16519	64)
16520	79) LD C,A
16521	6) LD B,8
16522	8)
16523	203) RIC C
16524	1)
16525	56) JR C,+4
16526	4)
16527	22) LD D,0
16528	0)
16529	24) JR+2
16530	2)
16531	22) LD D,128
16532	128)
16533	126) LD A,(HL)
16534	254) CP 118
16535	118)

16536	40) JR Z,5
16537	5)
16538	114) LD (HL), D
16539	35) INC HL
16540	16) DJNZ,-19
16541	237)
16542	201) RET
16543	35) INC HL
16544	24) JR -8
16545	248)

Big characters — main program.

```
20 DIM D(4)
30 INPUT U$
40 FOR S=1 TO 4
50 LET D(S)=CODE U$(S)
60 NEXT S
70 FOR Q=0 TO 7
80 PRINT AT Q,Q;" (32 spaces)"
90 FOR S=1 TO 4
100 PRINT AT Q, (S-1)*8;
110 POKE 16507, PEEK (D(S))*8+7680+Q)
120 RAND USR 16514
130 NEXT S
140 NEXT Q
150 GOTO 30
```

(continued from page 135)

Storable screen display

THIS PROGRAM demonstrates the use of a subroutine which converts the display file into a character string, on an expanded ZX-81, writes John Bloxham of Stratford upon Avon, Warwickshire. The idea is to allow a display, e.g., a game board, to be retained and recalled when necessary, or Saved on to tape. Assuming you have enough memory, two or more displays may be stored and recalled in rapid succession, giving an animation effect.

Line 10 initialises D\$ — it will eventually contain the display. Lines 100-120 generate a simple test display. Line 200 hands over to the subroutine which loops through the display file and adds the characters into D\$. On returning from the subroutine, the display is cleared and the program stops. The previous display is now stored in D\$ and may be instantly recalled with a Print D\$.

This appears to be a fast way of printing a screenful of anything, but because the display is in a string, it may be processed by the string-handling commands. For example, add the following lines:

```
300 FOR X=1 TO 673 STEP 32
310 PRINT AT 0,0;D$(X TO)
320 NEXT X
```

Then Goto 300 — do not use Run — scrolls the display upwards. Change line 300 to:

```
300 FOR X=673 TO 1 STEP -32
```

and the display scrolls downwards. Now if the display is changed and the subroutine called again, further pictures may be

```
10 LET D$ = ""
100 FOR X = 0 TO 20
110 PRINT AT X, X;"SCREEN TEST"
120 NEXT X
200 GOSUB 1000
210 CLS
300 STOP
1000 REM STRING ROUTINE
1010 LET A=PEEK 16396+256*PEEK 16397
1020 FAST
1030 FOR B=1 TO 726
1040 IF PEEK (A+B) =118 THEN GOTO 1060
1050 LET D$=D$+CHR$ PEEK (A+B)
1060 NEXT B
1070 SLOW
1080 RETURN
```

```
300 FOR X=1 TO 673 STEP 32
310 PRINT AT 0,0;D$(X TO)
320 NEXT X
```

```
300 FOR X=673 TO 1 STEP -32
```

tacked on to D\$. Each display adds 704 bytes to the string. Program a loop to print chunks of D\$ 704 bytes long and you have animation. Finally, if the program is Saved on to tape then D\$ is Saved as well — though do not forget to re-start with a Goto after Loading.

Self-running program

I OWN a ZX-80 with the new 8K ROM, writes R Emery of Harrow, Middlesex. While experimenting one day, I put a line at the very beginning of the program which would Save it under a certain name. I started my tape recorder to record and pressed Run. Newline. The program then started to Save itself and once it had finished, it stopped where it started Saving.

```
5 DIM AUTHOR JOHN ALLEN
10 PRINT "SIMULTANEOUS EQUATIONS"
20 PRINT "INPUT NO OF ROWS"
30 INPUT R
40 PRINT "INPUT NO OF COLUMNS"
50 INPUT C
60 DIM A (R,C)
70 FOR H = 1 TO R
80 LET Y = A (H,H)
90 FOR I = 1 TO C
100 LET A (H,I) = A (H,I)/Y
105 NEXT I
110 FOR I = 1 TO R
120 IF I = H OR A (I,H) = 0 THEN GOTO 160
130 IF A (I,H) = 1 OR A (I,H) = - 1
140 IF A (I,H) > - 1 AND A (I,H) < 1 THEN GOSUB 3000
150 IF A (I,H) < - 1 OR A (I,H) > 1 THEN GOSUB 3000
160 NEXT I
170 NEXT H
500 FOR J = 1 TO R
510 PRINT "X"; J; "="; A (J,C)
520 NEXT J
530 STOP
1000 LET D = 1
1010 IF A (I,H) < 0 THEN LET D = -1
1020 FOR J = 1 TO C
1030 LET A (I,J) = A (I,J) - A (H,J) * D
1040 NEXT J
1050 RETURN
2000 IF A (I,H) = 0 THEN GOTO 2050
2005 LET Y = A (H,H) / A (I,H)
2010 FOR J = 1 TO C
2020 LET A (I,J) = (I,J) - A (H,J) / Y
2030 NEXT J
2040 RETURN
3000 LET Y = A (I,H)
3010 FOR J = 1 TO C
3020 LET A (I,J) = A (I,J) - A (H,J) * Y
3030 NEXT J
3040 RETURN
4000 FOR I = 1 TO R
4005 PRINT "INPUT ROW"
4010 FOR I = 1 TO R
4020 FOR J = 1 TO C
4030 INPUT A (I,J)
4040 CLS
4050 PRINT A (I,J)
4060 NEXT J
4070 NEXT I
4080 CLS
4090 RETURN
```

The next time I wanted to load it, I went through the normal procedure, and was astonished to see that the program had run itself. This is quite useful for some programs and I hope useful to other readers. For example
SAVE "PROGRAM 1"
10 PRINT "THE PROGRAM RUNS ITSELF"
20 GOTO 10

This works with the 8K ROM so it should work with the ZX-81 and might also work with the ZX-80 with 4K ROM.

Inspecting the RAM

AFTER USING a CBM micro with 16K Basic, I found the Sinclair ZX-81 Basic deficient in certain respects, writes Christopher Clarke of Colchester, Essex. One shortcoming which is easily rectified is that of not knowing how much memory remains for program/variables/screen use. The following short machine-code subroutine may be placed above RAM-Top or, as I prefer, inside a Rem statement using the Basic loader.

```
10 REM AAAAAAAAAAAAAAAAAAAAAA
20 LET A = 16514
30 INPUT B
40 IF B = -1 THEN END
50 POKE A,B
60 LET A = A+1
70 GOTO 30
```

Enter these numbers:

```
237, 115, 54, 64 ld (nn), sp
42, 54, 64 ld hl,(nn)
237, 75, 28, 64 ld bc,(nn)
237, 66 sbc hl, bc
pairs.
68, ld b, h
77, ld c, l
201, ret
```

(-1 to end loader)

Now delete all lines except line 10 and put:

```
20 let bc = usr 16514
30 print bc
```

Simultaneous equations

I WROTE this code listing for the ZX-81 for solving simultaneous equations, writes John Allen of London SE18. The program asks for the number of rows and then the number of columns. Then the complete problem is entered in a row at a time and element by element in the row.

I do not know the size of the program but I feel that with a 16K RAM pack, it can solve up to 60 simultaneous equations with 60 variables. I have only been able to test the program with nine variables and nine equations and I found that the program took less than 30 seconds to solve the problem.

$$\begin{aligned} X_1 + 2X_2 &= 4 \\ X_1 - 2X_2 &= 8 \end{aligned}$$

In this problem, there are two rows and three columns. When the number of rows and columns are input into the program, the data is input row by row.

And now for the performance of a lifetime!

Introducing 7 data-shielding improvements from Verbatim for greater disk durability and longer data life.

Improvements to protect your data from head-to-disk abrasion. Improvements to shield your data against loss due to environmental conditions. Improvements that will deliver a longer lifetime of trouble-free data recording, storage and retrieval than ever before possible.

1. A longer-lasting lubricant. Our new lubricant is more resistant to diffusion, to protect against data-destroying head-to-disk contact.

2. An improved liner. Our new liner cleans and removes debris better. It also enables more lubricant to reach the recording head, protecting against head wear.

3. A thicker, more durable coating. Our disks have a more uniform oxide coating for more adhesive and cohesive strength. We've also made it thicker; providing 10% more protective lubricant and an optimized signal resolution for the new recording heads.

4. Advanced polishing techniques. Our burnish-

ing makes our disks uniformly smooth, for better data transfer, less head wear.

5. Reinforcing hub rings. For critical applications, Verbatim disks are available with hub rings to aid in registration, eliminate slippage, reduce errors, and give you better alignment repeatability.

6. Testing standards that go far beyond industry standards. Every Verbatim disk meets or exceeds the most demanding of IBM, Shugart, ANSI, ECMA, and ISO standards—because we insist on Verbatim being

the industry standard of excellence.

7. A 100% Error-Free Certification. Our certification is not based on random sampling, or statistical averaging, it is based on extensive testing of every single disk. Therefore we can state that our disks really are 100% error-free, and back it up with a **full one-year warranty.**

Verbatim S. A.
P.O. Box 3
CH-1211 Geneva 19
Switzerland
Telephone: (022) 34-90-55
Telex: 22647 ITGE CH

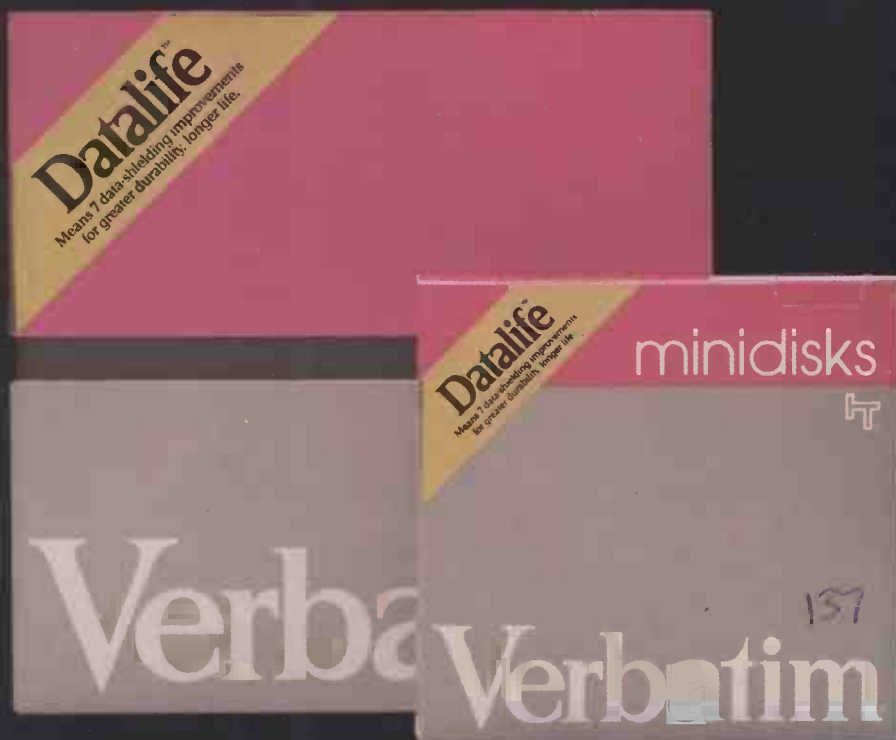

And behold...



...all was made clear.

The CX80 colour matrix printer lights the way to easier understanding of a wide range of applications including graphics, charts, histograms and image analysis. All becomes clear in seven colours, various hues and half-tones.

The CX80 incorporates all the features expected of a modern matrix printer and will print any dot or combination of dots in any of the seven basic colours with no restriction on the mixing of dots, characters or

colours along a line. The printer uses standard tractor fed paper and is easily connected to most micro and mini computers.

 **apple users**

—A card is available for dumping from a colour screen direct to the CX80 printer.

Contact D.N.C.S. and all will be made clear.



D.N. Computer Services Ltd.,

West Croft Industrial Estate, Manchester Old Road,
Middleton, Manchester, M24 4PJ.
Telephone: 061-643 0016 Telex 635091

Price from around **£895 + VAT**
Trade Enquiries Welcome

● **Circle No. 184**

Please bring a touch of colour into my life

Name

Address

Company

Tel. No.

PC 11/81

4MHz Z80A, 64K RAM, twin 200K disks, dual serial RS-232, CP/M 2.2 for £1299..

... or in plain English, the specification of the all-British Sig/net microcomputer is tailored to users' needs; high reliability, unrivalled flexibility and unbeatable price stem from its novel design concept — the simple interconnection of functional modules.

Sig/net uses the proven Z80A microprocessor and full 64K byte memory — ample workspace for the most sophisticated program. Its 400K byte disk storage satisfies most needs and standard interfaces ensure simple connection of all popular printers and terminals.

The CP/M disk operating system supports the most prolific range of off-the-shelf, proven software for accounting, stock control and word processing. The price needs no translation.

And that's only the basic specification. Floppy disk capacity can be greatly increased and hard disks, for massive

storage and fast data access, can be added. Full speed multi-user operation is also supported.

The Sig/net distributor/dealer network covers the UK and Eire (and much of Europe) so purchasers get full support from initial system specification and software selection — including specialised packages — to long term service needs.

The low cost Sig/net modules are available to OEMs. Besides processor/memory, serial and parallel i/o and power supplies, new additions are alpha-video, calendar clock and industrial i/o.

In any language Sig/net is the system no-one can afford to ignore.

Contact your nearest distributor for complete details and the address of your local Sig/net dealer.

North Micropute: contact Peter Casey 0625-612759 **South and East** Interam: contact John Lagan 01-675 5325/6/7 **South and West** Malvern Micro Systems: contact Ray Mansell 06845-68500 **Scotland** Video Vector Dynamics: contact Chris Morrow 041-226 3481 **N Ireland** ECL Group: contact Alan Richardson 0232-664737 **Eire** ECL Group: contact Reg Vian 0001-767042



shelton sig/net

COMPEC'81
Stand 7208

Shelton Instruments Limited
22-26 Copenhagen Street
London N1 0JD

Telephone 01-278 6273

● Circle No. 185

The DAI Personal Computer is For

- *High Performance*
- *High Value*

Cash price
 ONLY £595 + VAT
 BEAT THAT FOR VALUE

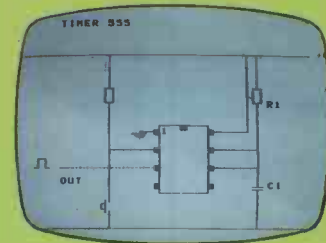
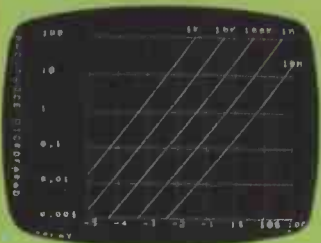
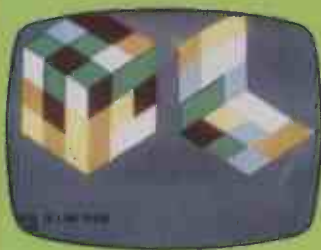

Standard Features

- * 24k Resident High-Speed Basic
- * 16 Colour High-Resolution Graphics (255 × 335)
- * Scrolling Screen Editor
- * Sound Commands for Music Generation
- * Very High Speed Hardware Maths Option
- * Resident Monitor for Machine Language Programming
- * 3 Programmable Parallel Ports
- * Standard TV Interface via Aerial Socket
- * RS232 Serial Port and Dual Cassette Interfaces

Manufactured by:

DAI

THE
 MICROCOMPUTER
 ENGINEERING
 COMPANY
 Brussels, Belgium.

Available from:

Data Applications (UK) Ltd.

Personal Computer Division
 16b Dyer Street
 Cirencester
 Gloucestershire
 GL7 2PF
 Tel: Cirencester
 (0285) 61902

For further information please complete and post to:
 Data Applications (UK) Ltd, 16b Dyer Street, Cirencester, Glos GL7 2PF

NAME: _____

ADDRESS: _____

MY INTEREST IS: _____

Racing game

RACE is a car-racing game from Nicholas Lloyd of Rottingdean, near Brighton. The aim is to complete one lap of the course as fast as possible without crashing.

To control the car you use the 8,2,4 and 6 keys to make the car go up, down, left and right respectively. The 5 key may be used as an accelerator. If you first press a key for the direction followed by 5, the car will proceed at an increased rate.

If you have a 3016 Pet then try Poke 59458,62, which has the effect of speeding up the program; to return to the normal speed, type Poke 59458,30. Do not use this on the 4032, as the only result will be to reduce the screen size to about four rows.

Upgrading from Basic 3

CBM HAS released a new DOS for the Pet disc, DOS 2.1, which is fitted as standard to the 4040 disc. The 2040/3040 units can be upgraded by a retrofit set of ROMs which cost about £40. The upgrade is useful since it clears many of the problems associated with the original DOS. The relative file facility allows more flexible direct access without the problems of block commands and descriptor files. However, the Pet would need to be upgraded to DOS 4 to realise this facility. The price of this retrofit is the same as for the disc.

There are two ways to upgrade a new-ROM Pet with Basic 3, writes M J Valentine from Rotherham. There is the official ROM set and an independent manufacturer's ROM.

The official Commodore retrofit allows a Basic-3 machine to be upgraded to Basic 4. The main features of Basic 4 allow faster running and disc access without the use of DOS support or print#.

The shifted Run/stop allows a properly retrofitted system to load the first program from Drive 0 and Run. Basic 4 allows handling of relative files, which is mandatory with DOS 2.1. The snags of the retrofit upgrade are mainly due to changes in the main subroutine entry points.

The zero-page locations are similar to Basic 3, but the values are different in many cases, e.g.

Stop key disable	Enable
Basic 3 Poke 144,49	Poke 144,46
Basic 4 Poke 144,88	Poke 144,85

All Basic-3 programs will run on Basic-4 machines, but some modifications will be needed to Poke, USR and Sys. The Run/stop disable is the best example.

The big problems come with machine-code programs, e.g., Wordcraft, Invaders, Microchess, etc. which will not run. A Basic-4 version will have to be purchased at more expense. Toolkit and other system chips will have to be replaced.

Open4,4:CMD4:Sys1024 will not

```

40 PRINT "J":POKE59468,14
50 PRINT "*****"
60 PRINT "*****"
70 PRINT "*****"
80 PRINT "*****"
90 PRINT "*****"
100 PRINT "*****"
110 PRINT "*****"
120 PRINT "*****"
140 PRINT "*****"
150 PRINT "*****"
160 PRINT "*****"
170 PRINT "*****"
180 PRINT "*****"
190 PRINT "*****"
200 PRINT "*****"
210 PRINT "*****"
220 PRINT "*****"
230 PRINT "*****"
240 PRINT "*****"
250 PRINT "*****"
260 PRINT "*****"
270 PRINT "*****"
280 PRINT "*****"
282 PRINT "PRESS A KEY!"
283 GETW$:IFW$=""THEN283
284 PRINT "J"
290 TIM$="000000"
300 A=33585
310 POKEA,35
320 IFPEEK(151)=42ANDPEEK(A-1)=42THEN400
330 IFPEEK(151)=42ANDPEEK(A-1)=32THENPOKEA-1,35:POKEA,32:A=A-1:B=-1:GOTO370
335 IFPEEK(151)=41ANDPEEK(A+1)=42THEN400
340 IFPEEK(151)=41ANDPEEK(A+1)=32THENPOKEA+1,35:POKEA,32:A=A+1:B=1:GOTO370
345 IFPEEK(151)=50ANDPEEK(A-40)=42THEN400
350 IFPEEK(151)=50ANDPEEK(A-40)=32THENPOKEA-40,35:POKEA,32:A=A-40:B=-40:GOTO370
355 IFPEEK(151)=18ANDPEEK(A+40)=42THEN400
360 IFPEEK(151)=18ANDPEEK(A+40)=32THENPOKEA+40,35:POKEA,32:A=A+40:B=40:GOTO370
370 IFPEEK(A-1)=94THEN390
372 IFPEEK(151)=34THEN374
373 GOTO320
374 IFPEEK(A+B)=42THEN400
375 IFPEEK(A-1)=94THEN390
376 POKEA+B,35:POKEA,32:A=A+B
377 IFPEEK(151)<>34THEN320
378 GOTO374
390 PRINT "TIME":PRINTMID$(TIME$,3,2):" \INS ":RIGHT$(TIME$,2):" *SECONDS"
395 POKE158,0:END
400 POKE59468,12
405 PRINT "J"
406 PRINT "*****"
407 PRINT "*****"
408 PRINT "*****"
409 PRINT "*****"
410 PRINT "*****"
411 PRINT "*****"
412 PRINT "*****"
420 PRINT "*****"
421 PRINT "*****"
422 PRINT "*****"
423 PRINT "*****"
424 PRINT "*****"
425 PRINT "*****"
426 PRINT "*****"
427 PRINT "*****"
428 PRINT "*****"
429 PRINT "*****"
430 PRINT "*****"
431 POKE158,0:FORG=1TO800:NEXTG:PRINT "*****"
432 GETR$:IFR$=""THEN432
433 IFR$="V"THEN40
    
```

allow Tim to be directed to the printer. You must use

OPEN4,4:CMD4:SYS 54395 since Tim's location has been shifted. The upgrade to DOS 2.1 and Basic 4 therefore calls for re-purchase of a Toolkit and other firmware.

The second alternative to Basic 4 is to use a ROM which works by intercepting a command before Basic 3. Disk-o-Pro is one such ROM, but costs more than the official CBM retrofit set.

Disk-o-Pro has the advantage of allowing the use of all Basic-3 software, including Wordcraft, Toolkit and Invaders, and does not require re-purchase as the official kit does. All Basic-4 disc commands can be used if DOS 2.1 is retrofitted. Also included are extra commands, e.g., Print Using, which should have been included in CBM Basic.

For £57 you receive a chip which plugs

into the \$9000 ROM expansion socket. If a VisiCalc chip is present, then ROM expanders are available to allow several chips to be used. On power-up, the Disk-o-Pro chip must be called by Sys36864 to display

DISK-O-PRO (C) 1980 ROB CHANG (C) 1979 PAICS

Toolkit is called automatically, if present. All the commands are available as well as the Basic 4. Disc commands include an execute command — the same as t0: program of DOS support — and scroll, which is very useful when dealing with program listings.

Kill will leave the Pet without Disk-o-Pro which is incompatible with other programs using the Chartgot area. However, all the commands may be in program or direct mode so that Disk-o-Pro may be activated by a Basic program.

(continued on page 143)

Horses for courses they say. We could not agree more.

That is why we have a flexible stable when it comes to helping businessmen choose a micro-computer system.

We need to know something of your business before we can advise you on making the final selection of the relevant system.

Once we have done that we move very quickly:-

We will provide a full demonstration, and if off the shelf business packages do not meet your particular needs, we will design special computer systems that do.

We will train you and your staff.

We will arrange finance — hire purchase or leasing.

We give a full after sales advisory service, and naturally, we offer rapid servicing and comprehensive maintenance contracts.

The best way for us to demonstrate our capabilities, is for you to tell us about your business needs.

One thing is certain.

It is odds-on that between us we will arrive at the best bet.

Write or telephone for further information to:

MICRO FACILITIES

Micro-Facilities Limited
129 High St, Hampton Hill
Middlesex TW12 1NJ
01-979 4546 and 01-941 1197

A member of the MF Group of companies

Please Tick As Applicable

Please Send Me Further Details

Please Have Your Consultant Call Me

Micro-Facilities Ltd, FREEPOST,
Hampton, Middlesex, TW12 1BR
Tel: 01-941 1197 or 01-979 4546

Name Mr/Mrs/Miss _____

Address _____

Post Code _____

Tel _____

FREEPOST — NO
STAMP NEEDED

P.C 01-DR



All potential winners. If you put them in the right race.

142

```

100 REM* M VALENTINE 16.6.81
110 REM
120 REM* WORKS LIKE "D1=0" COMMAND TO DISK
130 REM
140 REM* BLOCK 19 ON TRACK 13-24 CANNOT BE
150 REM
160 REM* COPIED AND IS DUMPED ONTO PRINTER
170 REM
180 REM* DO NOT USE THIS PROGRAMME TO COPY
190 REM
200 REM* FILES WITH A DIRECTORY ENTRY
210 REM
220 REM* USE FOR RANDOM ACCESS FILES
230 REM
240 REM* ERROR # 22 READ ERROR WILL OCCUR IF
250 REM
260 REM* DATA HAS NOT BEEN WRITTEN TO THE BLOCK
270 REM
280 REM* THIS SHOULD BE IGNORED
290 REM
300 PRINT"DO NOT COPY DIRECT ACCESS FILES FROM 2040/3040 TO 4040 FORMAT"
310 PRINT
320 PRINT"PLACE DESTINATION DISK IN DRIVE 1"
330 PRINT
340 PRINT"PRIMARY DISK TO DRIVE 0":GOSUB610
350 PRINT
360 PRINT"DATA ON DRIVE 1 WILL BE LOST":GOSUB610
370 PRINT
380 OPEN15,8,15
390 PRINT#15,"U":PRINT#15,"I0":PRINT#15,"I0":GOSUB630
400 OPEN2,8,2,"#":ID$="":PRINT#15,"U1":2:0:18:0:PRINT#15,"B-P":2:144
410 FORP=1T020:GET#2,Q$:ID$=ID$+Q$:NEXT
420 PRINT"FORMAT DRIVE 1 "ID$:PRINT#15,"N1":"LEFT$(ID$,13)","RIGHT$(ID$,2):GOSUB
630
430 CLOSE2:CLOSE15
440 FORT=1T017:FORS=0T020:GOSUB570:NEXT:NEXT
450 T=18:FORS=1T018:GOSUB570:NEXT
460 FORT=19T024:FORS=0T018:GOSUB570:NEXT:NEXT
470 FORT=25T030:FORS=0T017:GOSUB570:NEXT:NEXT
480 FORT=31T035:FORS=0T016:GOSUB570:NEXT:NEXT
490 OPEN2,8,2,"#":OPEN15,8,15
500 FORT=18T024:S=19:PRINT#15,"U1":2:0:T:S
510 OPEN4,4:PRINT#4,"BLOCK TRACK"TAB"SECTOR"TAB"ID$
520 PRINT#4,"THE FOLLOWING DATA CANNOT BE TRANSFERRED"
530 FORI=0T0254:GET#2,Q$:PRINT#4,Q$:NEXT:PRINT#4,"END OF DATA"TAB,"S
540 PRINT#4:CLOSE4:NEXT
550 PRINT#15,"I":GOSUB630:CLOSE2:CLOSE15
560 PRINT"HOME":END
570 OPEN2,8,2,"#":OPEN15,8,15
580 PRINT"COPY"TAB,"S":PRINT#15,"U1":2:0:T:S:GOSUB630
590 PRINT#15,"U2":2:1:T:S:PRINT"CHECK":GOSUB630
600 CLOSE2:CLOSE15:RETURN
610 GETQ$:IFQ$=""THEN610
620 RETURN
630 INPUT#15,N$,M$,T$,S$
640 PRINT" = "N$,"M$","T$","S$
650 RETURN
660 A$="00: COPY BLOCKS":SAVEA$,8:SAVEA$,8:VERIFYA$,8
    
```

(continued from page 141)

Other snags include

- a 20 percent reduction in execution time
- tape #2 buffer cannot be used — the same applies to Basic 4 if disc in use
- Supermon, DOS support, etc. are incompatible
- after every disc operation the error channel is checked, unlike Pet Basic 4; this includes direct operations like Directory, Copy and Get#, which will cause a considerable delay if many Get#s are used.

Anyone considering upgrading to Basic 4 should consider Disk-o-Pro as a more economic alternative if Toolkit is being used.

As previously mentioned, to obtain the full benefits of Basic 4, the disc unit should have DOS 2.1 or 2.5. For about £40 you receive as set of four chips. Three are 24-pin and one is 40-pin.

CBM do not appear to have produced any directives on where to put the chips. The spare DOS expansion socket is used. DOS 2.1 will then cause automatic initialisation of Drive 0, the command only being required for direct access. The familiar noise of initialisation of DOS 1 is only heard if a problem occurs or on power up.

DOS 1 and DOS 2.1 are read-compatible but not write-compatible. When a

disc has been formatted by the New or Header command, the DOS format is written to the header: 2a indicates DOS 2.1, a blank or 1 indicates DOS 1.

The duplicate command cannot be used to copy a disc DOS 1 to DOS 2.1 or vice versa. If an attempt is made to write to a 2.1 disc with DOS 1 then the error channel is not updated and will crash.

To transfer data from DOS 1 to DOS 2.1 is simple. The program Copy Disc Files supplied by CBM on the demonstration disc is useful as long as the destination disc is Newed before copy is attempted. Copy can be done in the direct mode using Basic 4 and Basic 3, with or without DOS support. In Basic 4,

```

HEADER "DISK NAME", D1, I(ID)
COPY D0 TO D1
    
```

In Basic 3,
OPEN15,8,15:PRINT#15,"n1:disk name,id"
PRINT#15,"C1 = 0"

```

With DOS support,
) n1:disk name, id
) o1 = 0
    
```

This will work on the upgraded disc, providing that the files have a directory entry. It will not copy a direct-access file written by a b-w or u2 command.

There is no facility to transfer files directly. Another problem is that on

tracks 18 to 24, block 19 does not exist in DOS 2.1, otherwise a block-for-block transfer would work. This problem occurred with a mailing-list file. The program Copy Blocks is a partial solution which prints out the uncopyable blocks. The result is a compatible disc without six blocks of data.

The direct-access disc is usually drive 1, and a descriptor file is usually in drive 0. If a missing block is called after transfer over then a No Block or Illegal t/s error will occur. If the program can be listed, the appropriate modification should be made or the descriptor file modified. In any case, a direct-access disc file should be replaced by a relative file with the appropriate program modifications to take full advantage of DOS 2.1 and Basic 4.

The other problem that was encountered is that Block Write is not available with DOS 2.1. The manual suggests replacement with the u2 command, but you will have to check the buffer pointers, and the commands may have to be modified.

Closure test

IN MOST programs it is desirable to test the keyboard for the closure of a particular key, either in response to a menu page or just to advance to the next page of text. T. P. Brown of Bath has sent a simple common subroutine which does the job.

You should set the following variables before calling:

- KP:— = 0 — return on any key
- = 1-9 — return on any of the number KP of keys defined in KPS
- KPS(1)-(9);— Keys on which to return.

You call the subroutine with Gosub 10000, and should test with the two call routines.

```

100 REM *****
110 REM * CALL ROUTINE (1)
120 REM *****
130
140 PRINT"PAGE ONE"
150 PRINT"WHIT A KEY"
160 KP=0:GOSUB10000
170 PRINT"PAGE TWO"
180 END
190
200 REM *****
210 REM * CALL ROUTINE (2)
220 REM *****
230
240 KP=3:KP$(1)="1":KP$(2)="B"
250 KP$(3)=CHR$(13):GOSUB10000
260 ONKP0T0200,290,300
270 GOT0240
280 PRINT"YOU HIT KEY 1":GOT0240
290 PRINT"YOU HIT KEY B":GOT0240
300 PRINT"YOU HIT RETURN":GOT0240
310
10000 REM *****
10010 REM * MAIN ROUTINE
10020 REM *****
10030
10040 POKE158,0
10050 GETA$:IFA$=""THEN10050
10060 IFKP=0THENRETURN
10070 FORI=1TOKP
10080 IFA$=KP$(I)THEN10100
10090 NEXTI
10100 KP=I:RETURN
10110
10120 REM *****
10130 REM *FOR OTHER THAN C.B.M. BASIC
10140 REM *USE IN LINE 10040
10150 REM * 'FORI=1T010:GETA$:NEXTI'
10160 REM *THIS IS FOR A 10 CHR BUFFER
10170 REM *****
    
```

IN WHAT has been rightly described as an amazing triumph, Thumper and Sterling Mouse — first and second in the British heat — trounced the best of the rest of Europe in the Paris final. However, Thumper's days as champion may already be numbered — plans for next year's heats at the London Computer Fair, April 23, 24, 25 and Micro-Expo in Paris in June. The European final will be held in Haifa in Israel — and there is talk of a world final in London in September.

In case you are not sure what the competition is about, here is a brief resume of

by Nick Smith

the rules. The objective is to build a self-contained robot — otherwise known as a mouse — which can reach the middle of a maze. The maze used for the London final is shown in figure 1.

The start is always at the bottom left-hand corner with the mouse pointing north. The finish is always the centre four squares, though the position of the entrance to the centre and the hole for recovering exhausted mice can both be moved. A mouse has 15 minutes to make as many runs as it can from start to finish; the fastest run is recorded and the fastest mouse wins.

Handling mice is allowed but the judges take a dim view of it. An unhandled mouse will always beat a handled mouse regardless of the times.

The maze is based on a 16-by-16 grid of 18cm. squares — overall about 9ft. square. Walls are 5cm. high and 12mm. thick. The walls of the maze are built out of 18cm. long pieces plugged into the base so that the design of the maze can be, and is, changed from day to day. The individual walls have a tendency to lean in random directions and occasionally there are slight gaps at the joints — beware.

The base is made of several pieces of smooth black-painted chipboard. Joints tend to run along the middle of passages and steps and gaps of up to 2mm. are not unknown — beware of tiny wheels and skidding.

The mice must be entirely self-contained — no trailing wires, no remote control. Maximum size is 25cm. by 25cm. with no height limit. Damaging or marking the maze is not allowed, although you might be allowed a ball of string. There is a limit of one Newton on the force a mouse exerts on any wall.

The current state of the art can be seen from the 1981 Paris final. Despite hundreds of entries — more than 300 from Britain alone — only about 13 mice competed. Of these, only eight reached the middle of the maze in practice. Alan Dibley of Cheddar had the distinction of owning two of them: Thezeus — about 12 minutes — from the London heat and a new, faster mouse Son of Thezeus — 2 minutes 49 seconds. Thumper finished in 1 minute 15 seconds, and was the leading

New champions of the labyrinth

qualifier. As the 1980 champion, my own mouse Sterling was included in the eight finalists and Thezeus was eliminated.

As always seems to be the case, the mice were dogged by electrical and mechanical problems. One exception was Kim, a French mouse which is memorable as the only three-wheeler I have seen. Just like a child's tricycle, the front wheel is both driven and steered. At the French heat in May, it had electronic wall-sensing. At the final it had a large roller sensors about 2in. wide protruding on each side and another one in front. These were carved out of polystyrene and ran on the tops of the walls.

Steering was controlled by a micro-switch on each side at the front. Unfortunately, Kim's brain could not work out how to pass the first two traps in the maze. After circling for about 10 minutes, Kim was withdrawn.

Sterling Mouse ran next, managing a very pleasing time of 68 seconds. Sterling is running about three times faster now than it did last year.

Minitaurus from Tampere University of Technology of Finland then entered the maze. The crowd literally gasped when it started because of its incredible acceleration from rest. Minitaurus is very fast and uses infra-red sensors all round for short-distance, accurate sensing, and

It goes as fast as possible from corner to corner — where it has to stop anyway — remembering but ignoring side turnings. At each corner Minitaurus decides whether to continue or back-track to a side opening it has passed. Obviously, once you know where a side turning is, there are no stopping problems.

Minitaurus is fast and covers more ground than other mice during exploration but takes a worse initial route to the middle. This explains its poor first run time of 5 minutes 40 seconds. Minitaurus then started playing up. When it was finally coaxed into a second run, it seemed to be following the shortest route to the middle but the Finns withdrew it for some unknown reason, when it was about two-thirds of the way there.

With only Thumper left to run, Sterling was still the fastest mouse in Europe with Minitaurus the only other mouse to attain the middle in the finals. Thumper started as smoothly as ever and arrived at the middle in about two minutes. Thumper's second run was again slower than Sterling's best, but my defeat seemed inevitable — then Thumper suddenly stopped dead. With rising spirits, I watched Dave Woodfield and Arthur White of GKN Technology prod Thumper and carry it back to the start. Whatever happened now, Britain was first and second.

Sadly for me, Thumper re-started and ran the shortest route in an astonishing 44 seconds to become the new champion. Credit must also go to Andrew Keatley of Allen-Martin Electronics who wrote Thumper's software.

One of the more disappointing aspects of the competition was the lack of successful amateurs and young competitors. If you have any ideas on how to make the competition more open to amateurs, and how to separate the amateurs from the professionals, write in to the Micromouse page. One idea is to double the width of the maze passages and eliminate dead ends to make model-car approaches viable.

Practical Computing is also looking for ideas for chassis design and simple sensors. Remember, you receive £5 for each idea or tip published. So far, there is no definitive mouse design so anything new could be a winner. When Dave Woodfield and I were talking after the competition, we agreed a new approach was needed. Look out for at least one bicycle next year.

For an entry form and a full set of rules, write to: Dr John Billingsley, Department of Electrical and Electronic Engineering, Anglesea Building, Anglesea Road, Portsmouth PO1 3DJ.

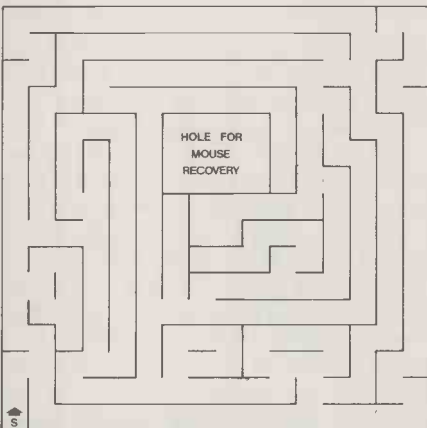

Figure 1. The London maze.

sonar on the front for long-distance detection so that it can stop before it hits a wall.

I had heard that maze-solving was not the forte of Minitaurus because it tends to run in long straight lines ignoring likely side turnings. I now realise what it was doing. Like Kim in the French heat, Minitaurus cannot stop in time to turn when it detects a side opening in a previously unexplored passage. Most mice, therefore, run slowly while exploring and stop to decide where to go at each junction: Minitaurus does the opposite.

MORROW 26Mb HARD DISK + STARLINK 2



+ NORTH STAR HORIZON

The respectable North Star Horizon is now married to the equally well accepted Morrow Discus M26 hard disk. Starlink is the best man — a multi-user CP/M designed to join together and increase the price/performance ratio of the happy couple. As good friends of the family you can rely on us to provide helpful advice and support. To make it all work, we can supply a choice of VDU's, printers and a variety of CP/M software.

If new additions to the family are wanted, then it's a simple matter to add further screens, memory and I/O up to a maximum of seven users, all at a price you can afford.

STARLINK — Multi-user Starlink is a time sharing operating system allowing a number of users to share a microprocessor and its peripheral devices. Starlink integrates the North Star floppy drives with the Morrow M10, M20, or M26 hard disks. Both types of disks then appear as logical drives under CP/M. The floppy disks can be used for backup and transfer of data and programs.

Each user can have a private logical drive B. Drive A is treated as a shared disk drive and can be used to store application software, system utility programs and shared databases. Logical drives C and D are the two floppy disk drives of the North Star.

A name and an associated password for each user is stored within the system executive. This provides basic system security. Users can log-in and out of the system independently. There is a turnkey facility which can be set up and locked in to a user by the system supervisor. This is a useful feature for running application programs and to prevent unwanted access to the CP/M command level. The right serial port of the North Star is designated for the printer. Any user can use the printer and printer locking is implemented.

The **DISCUS M26** is a complete 26Mb hard disk system in a metal cabinet with power supply, cables and an S100 controller. The M26 features the Shugart SA4008 14" Winchester style sealed disk. The S100 controller incorporates intelligence to supervise all data transfers, communicating with the CPU via four I/O ports. There is a 512 byte sector buffer on-board.

Multi-user Starlink requires a North Star Horizon with a bootstrap address set at E800, 4K non-bankswitching RAM addressed from F000 to FFFF, and 56K or 58K bankswitching RAM for each user. Also, each user requires an associated RS-232 I/O port for the VDU.

64K Horizon with 2 d/sided drives Morrow 26Mb Hard disk Starlink S/W TOTAL SYSTEM PRICE: £4995.00 +VAT.
Please write or phone for further details.

Prices and specification are subject to change without notice. CP/M is a trademark of Digital Research Corp. Horizon is a trademark of North Star Computers Inc.

INTERAM

INTERAM COMPUTER SYSTEMS LTD.
46 Balham High Road,
London, SW12 9AQ.
Telephone: 01-675 5325/6/7

145

● Circle No. 188

FOUR GOOD REASONS FOR CHOOSING GUESTEL

1. The Systems – Whatever your micro computer hardware or software requirements, Apple systems can meet them and we can supply them to rent or buy. Visit our showrooms in London, Brighton and Bristol or use our nationwide mail order service – one of the largest and most efficient in the country. Guestel provide sales, service and an in depth knowledge of Apple systems. We buy bigger so you can buy cheaper.



2. The Consultancy – Micro computer systems are simple to use once you know how. But how do you learn when so much of the so-called advice is in confusing computer jargon? Come to us. We talk plain English. Quite simply, we will help you to identify your particular needs for hardware, software and support services – then we'll match them with Apple systems.



3. The Service – Immediately you come to us with your needs you'll get a personal service. Whatever your requirements, we respond right away. And once your equipment is installed our reliable back up service ensures that help is always on hand



when you need it. We operate a two tier maintenance agreement, with a 24 hour call out service. We also have an in house engineering facility and a telephone enquiry service to cope with emergencies. Our fast, efficient mail order service will take care of your additional requirements and our offices are within easy reach.



4. The Know How – Some of Britain's leading companies have come to us for help in developing major custom built micro computer linked systems – your guarantee that we have the depth of technical knowledge and the experience to help with your needs, large or small.

GUESTEL
EXPANSION THROUGH EFFICIENCY

MAIL ORDER – BRIGHTON
15 GRAND PARADE BRIGHTON
EAST SUSSEX BN2 2QB
TELEPHONE 0273 695264

HEAD OFFICE – LONDON
8-12 NEW BRIDGE STREET
LONDON EC4V 6AL
TELEPHONE 01-583 2255

BRISTOL OFFICE
41-43 BALDWIN STREET
BRISTOL 1

OFFICES WORLDWIDE
DUSSELDORF
SAN FRANCISCO

Apple III
now
available

AUTHORISED APPLE DEALER AND LEVEL ONE SERVICE CENTRE



LONDON COMPUTER CENTRE

RADIO SHACK DAISYWHEEL PRINTER II £950

60 CHARACTERS PER SECOND — THE FASTEST DAISYWHEEL PRINTER

- * EXCELLENT PRINT QUALITY — SUPERIOR TO MOST FAMOUS
- MAKES * BUILT IN PROPORTIONAL SPACING * LOOK AHEAD LOGIC
- * USES RICOH RP-1600 DAISYWHEELS

Heavy duty commercial daisywheel printer, with high quality printout, coupled with low noise necessary for office environment * 124 chrs * upper/lower case * 10/12 chrs per inch giving 126 & 163 columns * 15 inch wide friction platen * bolding * underline and a host of other features.

* Centronics type Parallel interface as standard. * Options: Series interface £60, PET Interface £65, APPLE interface £75.

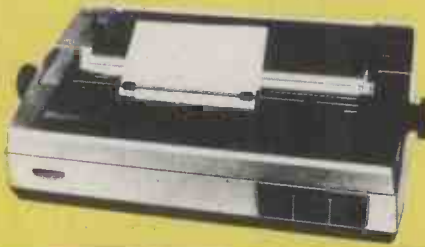

OPTIONAL BI-DIRECTIONAL TRACTOR FOR RICOH

RP-1600

RADIO SHACK DAISYWHEEL II £95

Other Daisywheel Printers

QUME RO	£1550
QUME KSR	£1795
NEC RO	£1795
RP-1600S	£1500

SUPERBRAIN WITH NEW EXTRA FEATURES FROM £1795*



- * 16% Greater Disc Capacity
- * Faster disc Access
- * Auto Repeat on all Keys
- * 18 Programmable Keys

Now with multi-coloured dedicated keys for Magic Wand and Wordstar; the ultimate word processors.

* £ = \$1.80

EPSON DUAL MODE PRINTERS

LETTER QUALITY & STANDARD DOT MATRIX IN ONE LOW COST UNIT

MX-80 F/T £399
LETTER LIKE PRINT QUALITY
3 WAY PAPER HANDLING

1. Letterheads or A4
2. Fanfold
3. Paper Rolls

LOW NOISE
132 COLUMNS PER LINE
JAPANESE RELIABILITY
MX-80 F/T2 £440
MX-100 F/T £575



The only full 15" width platen printer with dual print modes & built in dot matrix & built in hi-res. graphics.

Full specification as the MX-80 F/T.

AUTHORISED TANDY DEALERS

COMPLETE MODEL I 48K SYSTEM

SPECIAL OFFER: LIMITED PERIOD 48K System — 16K keyboard, 32K Expansion Interface, dual Disc Drives, Green VDU, complete with all cables. £999

16K keyboard with UHF Modulator	£375
16K System with VDU & Cassette	£475
32K Expansion Interface	£289
Dual Disc Drives	£399

MODEL II

from £1999 including CP/M

State-of-the-art generation computer. Over 10,000 already sold in USA. 8 slot bus ensures expansion to hard discs and other peripherals. 76 key professional keyboard. Self test on power up. CP/M 2.2, TRSDOS & Level III BASIC are standard. CP/M 2.2 enables a vast range of CP/M software to be used on the MODEL II.



MODEL III

From £550

16K without disc drives	£550
48K without disc drives	£599
48K with disc drives	£1399
With Epson MX-80 and Scripsit for Wordprocessing	£1799

CP/M SOFTWARE WORD PROCESSORS

WORDSTAR	£275
WORDSTAR WITH DEDICATED KEYS	£340
WORDSTAR MAIL-MERGE	£65
MAGIC WAND	£185
MAGIC WAND WITH DEDICATED KEYS	£250
SPELLBINDER	£185
SPELLBINDER WITH DEDICATED KEYS	£250

DATA BASE SYSTEMS

DBASE II-RELATIONAL DATA BASE	£375
CONDOR	£250
TIM	£75

CRITICAL PATH ANALYSIS

MILESTONE	£250
-----------	------

TRS-80 MODEL I SOFTWARE

ELECTRIC PENCIL (DISC)	£60
SCRIPSIT (DISC)	£61
SCRIPSIT (CASSETTE)	£25
MAIL-MERGE FOR PENCIL & SCRIPSIT	£45
VAT AID PROGRAMME	£45
CCA DATA MANAGEMENT SYSTEM	£125
FINANCIAL PLANNER/ MODELLING	
T/MAKER	£175
TARGET	£250
MINI-MODELLER	£350

THE SPECIAL LCC APPLE SYSTEM

48K Apple, Dual 40 Track Disc Drives & 12 Green Screen Monitor	£1395
Double Vision 80x24 Card	£170
CP/M Softcard	£175
16K RAM (Integer) Card	£95
Centronics Parallel Card	£75
Serial Printer/Communications Card	£85

ALL PRICES ARE EXCLUSIVE OF VAT AND DELIVERY
DEALER ENQUIRIES INVITED ON ALL PRODUCTS

43 GRAFTON WAY, LONDON W1P 5LA (Opposite Maples)

OPENING HOURS: 11-7 MON-FRI 12-4 SAT Tel: 388 6991/2

24 hour answer phone: 01-388 5721

IF ANY OF THE FOLLOWING WORDS GIVE YOU A BUZZ . . . ANALYSIS STATISTICS DESIGN PLOTTING GRAPHICS REPORT WRITING SPECIFICATIONS SCHEDULES COSTING PLANT MAINTENANCE PRODUCTION CONTROL SIMULATIONS IEEE INTERFACING INSTRUMENT CONTROL MONITORING TERMINAL COMMUNICATIONS PAPERTAPE READING PUNCHING & EDITING SELF PROGRAMMING BASIC ASSEMBLER LANGUAGE MACHINE CODE . . . **GIVE US A BUZZ (OR SEND BACK THE COUPON)**

The micro comes of age. The PET has come a long way since micros were regarded as toys. It's designed and built for demanding work and this shows in the 32K memory and 80 column screen as well as in its impressive disk capacity. When it comes to languages, you'll find the PET fluent in BASIC, PASCAL, FORTH, COMAL, LISP, PILOT and ASSEMBLER.

It can be used as a complete system in itself, or can be linked to other PETs or a mainframe.

Who needs PET? And why? The list above speaks for itself, but that's only part of the story as the PET now has over 600 applications. It's good news for any engineer who's tried to get even a modest budget approved – the PET is very acceptable to the most sceptical of money people.

It's an attractive proposition, too, to DP professionals who need their fingers on the pulse and are fed up with waiting for their turn on the company computer.

In fact, it's the nearest thing to the all-purpose computer for everyone. An extravagant claim? A demonstration can prove it to be true.

The PET has track record. We've been involved with electronics for over 20 years and there are now over 40,000 PET installations in the UK. We manufacture our own microchip which is happily accepted and used by makers of other well-known microcomputers.

You get nationwide dealer back-up with Commodore.

What's more, many of our dealers have specific expertise – which means they can advise on anything from business systems to specialist technical applications. So, if your particular problem is of a highly specialised nature, it may be best to contact our Information Department direct. They will then recommend the dealers who understand – and who speak your kind of language.

What does all this cost? Not a lot. In fact, our computers start at £200 and go through to £3,000 – and that will buy you a complete system.

Which is just one more reason why any professional worth his salt would be interested in a microcomputer that's made its name in the business world . . . but is far more than just an efficient business brain.



Send to: Commodore Information Services, P.O. Box 109, Baker Street, High Wycombe, Tel: Slough 79292.

I'd like to know how a Commodore PET could give me a buzz.

Name

Company

Address

Tel:

COMMODORE PET Over 40,000 working hard for Britain

LONDON AREA

Adda Computers Ltd
W13, 01-579 5845
Byteshop Computerland
NW1, 01-387 0505
Capital Computer Systems Ltd
W1, 01-636 3863 & 637 5551
Centralex - London Ltd
SE13, 01-318 4213-7
Chromasonic Electronics
N19, 01-263 9493/9495
Healey Management Services Ltd
E1, 01-247 2858/3149
Home and Business Computers
E12, 01-472 5107
Logic Box Ltd
SW1, 01-222 1122/5492
Merchant Systems Limited
EC4, 01-583 6774
Meryclean Ltd
EC4, 01-236 2000
Micro Computation
N14, 01-882 5104
Micro Computer Centre
SW14, 01-878 7044-7
Sumlock Boudain Ltd
EC1, 01-250 0505
The Computer Shop (City) Ltd
EC1, 01-628 3531

HOME COUNTIES

Millhouse Designs Ltd
ALTON, 84517
The Computer Shop (Banbury) Ltd
BANBURY, 3477
H.S.V. Ltd
BASINGSTOKE, 62444
M.M.S. Limited
BEDFORD, 40601/2
Bracknell Computers
BRACKNELL, 52929
D.D.M. Direct Data Marketing Ltd
BRENTWOOD, 229379 & 230480
Amplicon Micro Systems Limited
BRIGHTON, 562163 & 608331
T & V Johnson (Microcomputers Etc) Ltd
CAMBERLEY, 20446
Wego Computers Ltd
CATERHAM, 49235
The Computer Shop (Caversham) Ltd
CAVERSHAM, 481555
Dataview Ltd
COLCHESTER, 865835

DeVind Computers Ltd
EDGWARE, 01-952 0526
Micro-Facilities Ltd
HAMPTON HILL, 01-979 4546
Cream Computer Shop
HARROW, 01-863 0833
L & J Computers
HARROW, 01-204 7525
South East Computers Ltd
HASTINGS, 426844
Bromwall Data Services Ltd
HATFIELD, 60980 67111
Alpha Business Systems
HERTFORD, 57425
Commonsense Business Systems Ltd
HIGH WYCOMBE, 40116
Kingsley Computers Ltd
HIGH WYCOMBE, 449749
Computer Sales & Software Centre Ltd
ILFORD, 01-554 3344
H.B. Computers Ltd
KETERING, 520910
H.B. Computers (Luton) Ltd
LUTON, 426887/416892
South East Computers Ltd
MAIDSTONE, 681263
Photo Acoustics Ltd
NEWPORT PAGNELL, 610625
WATFORD, 32006 & 40698
Sumlock Boudain (East Anglia) Ltd
NORWICH, 26259 & 614302
The Computer Shop (Oxford) Ltd
OXFORD, 722872
T & V Johnson (Microcomputers Etc) Ltd
OXFORD, 721461

Arden Data Processing
PETERBOROUGH, 49577 & 67831
H.S.V. Ltd
SOUTHAMPTON, 331422
Sumlock Tabdown Ltd
SOUTHAMPTON, 26647
D.D.M. Direct Data Marketing Ltd
SOUTHEND-ON-SEA, 65787 & 64589
Scan Computers Ltd
STORRINGTON, (09066) 5432
The Computer Room
TONBRIDGE, 355962
Orchard Computer Services
WALLINGFORD, 35529
Microchips
WINCHESTER, 68085
P.P.M. Ltd
WOKING, (04867) 80111
Petalact Limited
WOKING, (04862) 69032 & 21776

MIDLANDS
Byteshop Computerland
BIRMINGHAM, 021-622 7149
C.P.S. (Data Systems) Limited
BIRMINGHAM, 021-707 3866
Camden Electronics Limited
BIRMINGHAM, 021-773 8240
Joseph Ware Associates Ltd
BIRMINGHAM, 021-643 8033
Marchant Business Systems Ltd
BIRMINGHAM, 021-706 8232
Micro Associates
BIRMINGHAM, 021-328 4574
Peach Data Services
BURTON-ON-TRENT, 44968
Catlands Information Systems
CHESTER, 46327
PEG Associates (Computer Systems) Ltd
COVENTRY, 20246
Davidson-Richards Ltd
DERBY, 366803
Taylor Wilson Systems Ltd
DORRIDGE, (056 45) 6192
Cadeis Computer Systems Ltd
HINCKLEY, 613544

Arden Data Processing
LEICESTER, 22255
Roger Clark Business Systems Ltd
LEICESTER, 20455
A.J.R. Ltd
NOTTINGHAM, 206647
Betos (Systems) Ltd
NOTTINGHAM, 48108
Byteshop Computerland
NOTTINGHAM, 40576
PEG Associates (Computer Systems) Ltd
RUGBY, 65756
Synchro Computing Ltd
STOKE-ON-TRENT, 825391
Walters Computer Systems Ltd
STOURBRIDGE, 70811
The Computer Shop (Swindon) Ltd
SWINDON, 694061
McDowell, Knaggs & Associates Limited
WORCESTER, 28466

YORKS AND HUMBERSIDE
Ackroyd Typewriter & Adding Machine Co. Ltd
BRADFORD, 31835 & 32243
Allen Computers
GRIMSBY, 40568
Microprocessor Services
HULL, 23146
Microwave Computers Ltd
HULL, 562107
Holdene Ltd
LEEDS, 459459
Yorkshire Electronics Services Ltd
MORLEY, 522181
Computer Centre (Sheffield) Ltd
SHEFFIELD, 53519/588731
Holbrook Business Systems Ltd
SHEFFIELD, 484466
Estate Computer Systems
SLEAFORD, 305637
Mitrefinch Ltd
YORK, 52995

NORTH EAST
Curnie & Plaugan
GATESHEAD, 774540
Dyson Instruments
HETTON, 260452
Key Computer Services Ltd
NEWCASTLE-UPON-TYNE, 815157
Intex Datalog Ltd
STOCKTON-ON-TEES, (0642) 781193

MANCHESTER AREA
Byteshop Computerland
MANCHESTER, 061-236 4737
Computare Limited
MANCHESTER, 061-832 4761
Cytek (UK) Limited
MANCHESTER, 061-872 4682
Executive Reprographic Ltd
MANCHESTER, 061-228 1637
D. Kipping Ltd
MANCHESTER, 061-834 6367
Professional Computer Services Ltd
OLDHAM, 061-624 4065
Catlands Information Systems Ltd
STOCKPORT, 061-477 6699
Catlands Information Systems Ltd
WILMSLOW, 527166

LIVERPOOL
Stack Computer Services Ltd
BOOTLE, 051-933 5511
Aughton Microsystems
KIRKBY, 051-548 7788
Rockcliff Micro Computers
LIVERPOOL, 051-521 5830
The Computer Shop (Southport) Ltd
SOUTHPORT, 77783

NORTH WEST
B & B (Computers) Limited
BOLTON, 26644
Tharstern Limited
BURNLEY, 38481
Preston Computer Centre
PRESTON, 57684

WEST COUNTRY
Radan Computational Ltd
BATH, 318483
Calculator Services & Sales (Bristol) Ltd
BRISTOL, 779452/3
Sumlock Tabdown Ltd
BRISTOL, 276685
T & V Johnson (Microcomputers Etc) Ltd
BRISTOL, 422061
A.C. Systems
EXETER, 71718
South Coast Business Machines Ltd
FERNDOWN, 893040
Mitequip Ltd
GLOUCESTER, 411010
Devon Computers
PAIGNTON, 526303
A.C. Systems
PLYMOUTH, 260861
JAD Integrated Services (Plymouth) Ltd
PLYMOUTH, 662616 & 29038
J.M. Computer Services Ltd
TRURO, 71626

WALES
Sumlock Tabdown Ltd
CARDIFF, 41361
Sigma Systems Ltd
CARDIFF, 34869 & 21515
Reeves Computers Limited
CARMARTHEN, 32441/2
Computer Supplies (Swansea)
SWANSEA, 290047

SCOTLAND
MacMicro Ltd
BEAULY, 046-371 2774
Holdene Microsystems Ltd
EDINBURGH, 031-668 2727
Byteshop Computerland
GLASGOW, 041-221 7409
Gate Microsystems Limited
GLASGOW, 041-221 9372-4
Robox Ltd
GLASGOW, 041-221 8413/4
Ayrshire Office Computers
KILMARNOCK, 42972

NORTHERN IRELAND
Northern Ireland Computer Centre Limited
HOLYWOOD, (02317) 6548

AVAILABLE ON CASSETTE

★ **ASTROFACT** ★

★ FOR THE TRS-80 LEVEL II ★
REQUIRES 16K MEMORY

A NEW PROGRAM IN BASIC AT A SPECIAL INTRODUCTORY PRICE :

ONLY **£6.00** (U.K. inclusive of postage, packing and VAT. OVERSEAS inclusive of postage and packing. No VAT required) **BUY NOW FOR XMAS**

**IDENTIFY THE PLANETS AND STARS
PREDICT MOON'S POSITION ON YOUR OWN SKYLINE
IS IT A FIRST QUARTER OR A FULL MOON NEXT SUNDAY?
WHERE IS VENUS IN THE SKY ON CHRISTMAS DAY?**

Astrofact requests the input of year, month, day, time, also asks for latitude (North or South of Equator) and longitude (East or West of Greenwich) Astrofact then calculates and displays for each of the planets.

**MERCURY: VENUS: MARS: JUPITER: SATURN: URANUS:
NEPTUNE: PLUTO**

The following data which is displayed sequentially as calculated and then finally a complete list in tabular form:

Altitude in degrees above (or below) the horizon: Azimuth (compass bearing)
Right ascension: Declination: Phase: Apparent magnitude (brightness)
Distance from the Earth; for any date or time 1975-2001 incl.
Also SUN as above plus angular diameter,
And MOON as above plus angular diameter, and "age" (eg first quarter)

Additionally, Astrofact gives Altitude any Azimuth of an coordinates of right ascension and declination input by you, and displays also right ascension, declination, azimuth and altitude for the most important stars and star groups, examples: Sirius, Pleiades (Alycyone), Leo (Regulus), etc.

Orders despatched first class post with explanatory leaflet enclosed.

D. H. WOOLLEY (QUORN) LTD,
UNIT 2, WINDMILL ROAD,
LOUGHBOROUGH,
LEICESTERSHIRE,
ENGLAND.

**AN IDEAL PRESENT FOR
ALL AGES AND
EXCEPTIONAL VALUE FOR
JUST SIX POUNDS**

TELEPHONE: (0509) 217215.
TELEX: 34338.

● Circle No. 192

NEC PC-8000 !

AT LAST THE Z80A
COLOUR COMPUTER: CP/M
COMPATIBLE, BUSINESS-LIKE

"Superb value for money" —
PCW Bench Test, June 1981.



- KEYBOARD UNIT: * Z80A processor (4MHz)
* 32k RAM + 24k ROM. Powerful built-in Microsoft extended disk BASIC (24k) with screen editor, 8k user ROM slot.
* 83 key qwerty keyboard with N-KEY ROLLOVER for fast typist. Auto-repeat on all keys.
* 8 colours or 8 monochrome intensities — text or graphics.
* Graphics vector, plot & screen array storage functions.
* Scrolling area and line width control for screen (+ reverse, blink and secret). 36 to 80 character width, 20/25 lines.
* Double precision (16 significant figures), integer, hex.
* Built-in terminal capability for output to modem.
* Programmable function keys; separate numeric keypad.
* Interfaces for parallel Centronics printer, expansion units, disks and cassette.

JAPANESE QUALITY AND RELIABILITY

ALL FOR £599 ! (+ VAT)

- EXTRAS: * Memory expansion to 64k, 96k or 128k of RAM.
* CP/M 2.2 — the universal disk operating system.
* Dual 5 inch disk units.
* Superb colour or green monochrome monitor screens.
* Expansion boxes for extra RAM, RS232, IEEE 488, real-time clock, extra function and prototype boards. * Light Pen.
* Dot matrix printer; proportionately spaced text and graphics.
* New version of Spinwriter, also by NEC.
*** Specially commissioned Business Software for UK ***

Brighton Computer Centre

130 Lewes Road, Brighton BN2 3LG, E. Sussex. (0273-688946)
Write or phone for more details. Upgrades to 56k RAM (8k ext.)
Open Mon-Sat 10am-6pm.

● Circle No. 193

● Circle No. 191

THE GRID represents one-quarter of a chess board. A knight starts on any white square, and moves in normal knight fashion until it has visited each and every white square.

As it moves, it creates a running sum, for instance $5 \times 1 \times 6 \times 3 - 8 + 2 - 7 + 4 = 81$. Negative and fractional results are not allowed. What is the lowest score possible and how is it obtained? 

The solution to October's money puzzle

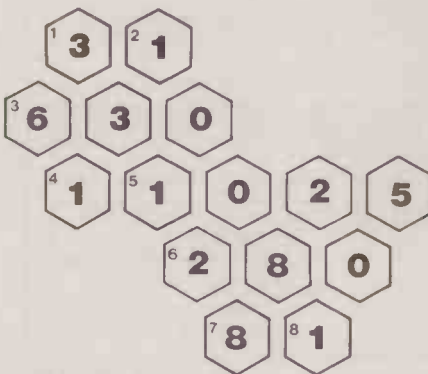

Knight's gambit

	5		1
3		2	
	7		8
6		4	



The Information Analyst Package

The Apple III Information Analyst contains everything you need to put the system to work for you today. With your order, you'll receive:

System Hardware

- Apple III Professional Computer System with built-in disk drive, calculator-style numeric pad, keyboard, serial (RS232) and Apple Silentype thermal printer interfaces, and 128 K bytes RAM;
- A second Apple Disk III disk drive; (optional)
- A 12", high-resolution, video monitor.

Software

- Apple's Sophisticated Operating System (SOS);
- VisiCalc III;
- Apple Business BASIC.

LEICESTER
computer centre limited
67 Regent Road, Leicester LE1 6YF.
Tel: 0533 556268

Retail Price
Information Analyst comprising: **£2,695**
128k Apple III
Monitor III
Information Analyst Software

Accessories
Disk III **£385**
Silentype III **£222**
Qume Sprint 5 45/RO (ex warranty) **£1,640**
Silentype II Conversion Kit **£22**
Vinyl Carry Case **£49**

Retail Price

Interface Cards
Prototyping Card **£32**
Software
Mail List Manager III **£90**
Pascal III **£150**

VAT EXTRA TO ALL PRICES

● Circle No. 194

An introduction to computer programming and data structures using Macro-11

By Harry R Lewis. Published by Reston. £19.20.

IT IS unusual these days for an introduction to programming to use an assembler-level language; this book uses that for the popular PDP-11 range. It is not an *ab initio* primer; it is aimed at those with some elementary programming knowledge.

The approach is similar to introductions to programming in high-level languages in that it takes a small logical group of instructions and explains their use with numerous examples. Where it differs is in that data storage and addressing are considered before any instructions are introduced — a consequence of using a low-level language.

However, for an introduction it goes into the various addressing modes too soon and too rapidly, which is likely to lead to confusion. Apart from that, the rest of section 1 is a clear description of the elements of Macro-11 without attempting to be exhaustive, as it is intended to be used with the language reference manuals.

As this book was written by a university lecturer, the examples are from a Unix operating system environment — consequently some of the Macros used will differ from those used by the DEC operating systems. The principles remain the same, however.

Considering the limitations of space in section 2, this book has been remarkably wide-ranging in its coverage of data structures. Not only does Harry Lewis cover all the common data structures including linked lists, trees and hash tables, he also manages to discuss language-syntax specification. This is discussed along with parsing and code generation in a superficial way as a basis for the programming projects in the third section.

The programming projects are for such system software as text editors, assemblers and compilers, and are obviously limited in scope. They consist of a common format of a defi-

nition of requirements which are built, piece by piece, into a functional specification at sub-routine level. The reader is then left to complete the program.

Although there are exercises throughout the book there are no answers. This only emphasises that the approach of the book is designed to be worked through with the aid of a tutor. That said, a programmer experienced in another language, preferably low-level, would find this book a useful introduction to Macro-11.

Conclusions

- As a basic introduction to programming or computers it is not ideal. For someone with some experience, it would be a good first step into Macro-11.
- With Macro-11 also being the language of the LSI-11 range, it is of interest to the microcomputer programmer.

Martin Wilson

Personal Computers Handbook

By Walter H Buchsbaum, published by Sams. U.S. \$11.95; U.K. £7.75. 286 pages paperback. ISBN 0-672-21724-4.

ONE WOULD have expected a book with a title like *Personal Computers Handbook* — whatever it means — from the powerful Sams stable to be an outstandingly useful treatment of the 1980s hobbyist's darling. One would be disappointed.

True, there is plenty here, from baby hardware theory to a sophisticated treatment of software — but it never seems to gel into a coherent whole. Dr Buchsbaum tends to skip around among his chosen topics without any obvious direction, without alighting for long on any one flower — however full of nectar — without drawing meaningful conclusions at any stage.

Perhaps that is what a handbook is — a work of reference in which one expects no more coherence than a bedside reader after a few pages of which one can rest easy? The task of reading it took me many more days than I expected, and I ended up with continued mixed feelings.

It is directed at "readers

who have a working knowledge of electronics and are interested in learning more about personal computers". Both parts of that quotation from the preface imply that this is not a book for beginners. It can be technical, but qualitatively rather than quantitatively. In other words it details what can be done, but not how to do it.

There are plenty of home-grown texts available which cover the micro better than this book. They may not be more up-to-date, or even more detailed — but they do follow a coherent line and keep a uniform level. I can foresee that I shall have occasion to use this book for reference — but keep it to hand? — no.

Conclusions

- A good, solid account, mainly of hardware. It does not, however, draw together to a readable whole.
- Not for the beginner keen to develop elementary knowledge, nor for the advanced micro user aiming to break new ground. For the rest, it is of some interest, but best first compared to other titles in the bookshop.

Eric Deeson

Apple Basic for business for the Apple II

Parker and Stewart. Published by Reston.

THIS BOOK sets out to teach Apple Basic by using examples drawn from business. The examples and problems are based on either payroll or stock systems and are built up stage by stage as the necessary facilities are introduced.

The book moves along steadily with comprehensive descriptions of each new concept. By the fourth chapter, files are in use, something most books leave until the later chapters. Sub-totalling and control breaks are introduced in chapter five, while file matching is discussed in the next two chapters. From chapter nine onwards, we are in strange territory as far as introductions to Basic are concerned — direct-access files.

Subsequent chapters deal with graphics and the different forms of business systems. All topics are explained in a clear

and concise manner which is very readable and there are the usual appendices of error codes and instruction formats. Also included is a very useful sort program which assumes disc files are in use, as do all the examples.

Each chapter has a summary at the end which provides a useful reference to formats and to techniques. There are also problems to test understanding of the topics introduced in the preceding chapter but unfortunately no solutions are given. This is something of a problem for this type of book as there is no one correct answer. Some guidance should be given to ensure that there are no misunderstandings which re-reading the chapter will not resolve. Strangely, for many of the programming problems there is a ruled page for the solution which is rather unnecessary — it looks suspiciously like padding.

No book, not even this one will turn the novice into a fully-fledged commercial programmer particularly as they all seem to be rather light on data validation and security. This book covers the trapping of some data errors but not enough to enable the reader to produce programs which will not be tripped up by errors in data entry.

Back-up copies of files are mentioned but no guidance is given as to when they should be made. The reader who studies this book conscientiously will be rewarded with a good foundation on which to build by experience and further study.

Any Apple user or, for that matter, anyone requiring an introduction would do well to consider this book — it will certainly be recommended by me.

Conclusions

- This book is very readable and accurate with well-chosen examples. It is one of the best introductions to Basic I have seen and I will certainly use it.
- The approach is not novel but is rather more consistent than most and provides a thread of continuity which this kind of text needs.
- If you are looking for a book on Apple Basic, this is probably the only one you will need.

Martin Wilson

THE ADMINISTRATOR

The only transactional
information
system

She would
love to
give you
a hand!

The
Businessmans
Dream

STAGE ONE SOFTWARE

300 Ashley Rd. Parkstone
Poole Dorset 0202-735656

● Circle No. 195

HOW A LITTLE BUSINESS GOT THE HOMEWORK DONE.



Whether you want to enjoy a little mental gymnastics or teach yourself to program we're probably in a prime position to advise you on your choice of Computer.

We've been installing and programming complex business systems for a year now, and we apply the same degree of experience to our personal software.

A sample of our wide range of hardware

is detailed below; and of course we've got all the software, peripherals and stock to go with them. So why not come along and see for yourself — we'll be pleased to discuss and advise.

	CHOICE OF MONTHLY PAYMENTS							
	NET	VAT	Total	MONTHS	24	30	36	
48K Apple II	725.00	108.75	833.75	Deposit	APR 34.2%	33.8%	33.2%	
48K Sharp MZ80K	450.00	67.50	517.50	83.37	41.87	35.62	31.42	
64K Sharp MZ80B	1095.00	164.25	1259.25	51.75	25.99	22.12	19.51	
5K Commodore VIC20	169.57	25.43	195.00	125.92	63.24	53.83	47.48	
16K Commodore Pet	460.00	69.00	529.00	19.50	10.48	9.09	8.13	
				52.90	28.42	24.66	22.04	

SHARP MZ-80B

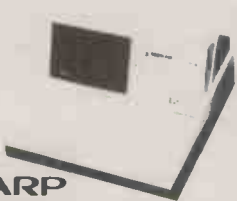

SHARP MZ-80K



apple II



VIC 20
commodore



COMMODORE PET

South West Technical Products S109 Computer System including 128K RAM, 2 Megahertz processor with full unifix operating system and 2½ megabytes disc storage on 8" disc drives.

Special Offer Price
£3995 + VAT

INSTANT CREDIT UP TO £750
QUANTITY DISCOUNTS



RAM

COMPUTER SERVICES LTD

RAM Computer Services Ltd.,
15-17 North Parade,
BRADFORD BD1 3JL.
Telephone: (0274) 391166.

● Circle No. 196

MICROCASE

"turns a board into a real computer"

For
**NASCOM 2
 COMPUKIT
 SUPERBOARD**

ALSO UNCUT FOR
 NASCOM 1 ETC.

Direct from us or from your
 dealer — but make sure you see a

GENUINE MICROCASE

SIMPLE SOFTWARE LTD
 15 HAVELOCK ROAD
 BRIGHTON, SUSSEX BN1 6GL
 (0273) 504879



● Circle No. 197

ALGOR ZX-80/81 Programs on Cassette

Code:
 1K80/1: Maze Battle, Missile Launch, Sketcher & Mazer.
 16K80/1: Mines and Monsters & Stockmarket.
 1K81/1: Missile Launch, Maze Battle, Mastermind & Sketcher.
 16K81/1: Mines and Monsters & Stockmarket.
 16K81/2: Shelob's Lair — The pictorial adventure game & The Economy Game — Try YOUR hand as Prime Minister.
 16K81/3: Machine Code entry system with complete label handling and amendment facilities, £5.00 (not available as listing).
 16KXMAS: Four games for 1 to 4 players: Mines and Monsters, Stockmarket, Economy Game & Commodities; a game of Bribery, Futures and Quick profits, £5.50.
 Order cassettes by code, price £3.20 except when shown otherwise.
 Listings: 1K — 60p per program or £1.80 for 4; 16K — £1.20 per program.
 Overseas carriage charge £2.00 per order. All Post and Pack included in the prices. Please send cheque or PO to:

ALGOR

Dovercourt, St James Road, Northampton
 Tel: (0604) 586462

● Circle No. 198

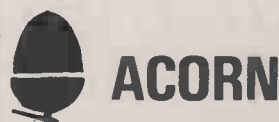

Your local Fruit and Nut

NORTHERN COMPUTERS
 128 Walton Rd., Warrington WA4 6NP

0925-601683

● Circle No. 199

Wynford and Jane James continue their series on portable graphics with a program which can be used in a variety of adventure games.

Maze-making subroutines

MANY GAMES require a subroutine which makes a maze to provide a variable background against which a battle can be fought or a chase can take place.

The various adventure games are in essence, maze games. The major difference is that in an adventure where you successfully go west across the Lava Sea, there is no guarantee that the reverse journey is possible. In a standard maze, the player who wanders into a dead end at least has the option of back-tracking.

This article describes a program which first generates a maze of random dimensions. It then displays a perspective view of the maze as the player searches for the exit.

The maze-creation routine, and a second routine which draws a map of the maze, are written so that they will run on any micro which has a memory-mapped display and supports Peek and Poke. The only changes required are to two lines in the initialisation routine.

The three-dimensional view of the maze requires several common graphics symbols: the horizontal, vertical and diagonal lines, and the four "corner" sym-

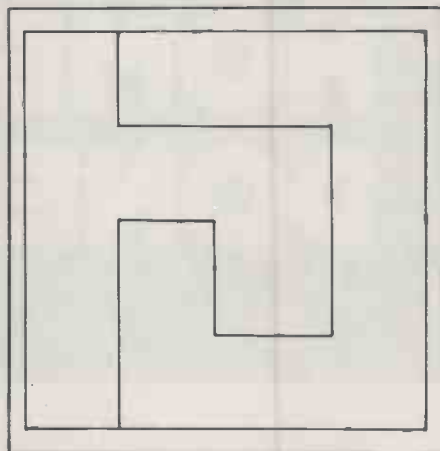

Figure 1. Maze with a dead end.

bols. These symbols are certainly available on the Pet, UK-101, Sharp MZ-80K and Superboard, and probably on most other popular micros too. The only change you may need to make in this part of the program is to substitute the symbols in your character set for those in the program — just three line changes. If your micro has a Plot command you will have to re-write this routine, but you should be able to simplify it considerably.

You may be looking sadly at your minimal memory configuration, thinking that this article cannot be for you. Let us reassure you — it was written on a 4K-RAM Superboard-II. If you have more than 4K of memory, you should be able to produce a full-blown adventure using the program as a basis.

Two main problems have to be overcome when creating a maze. Firstly, you must ensure that all parts of the maze are accessible from all other parts. There must be no "closed circuits" — see figure 1 — otherwise the effective size of the maze will be reduced and memory wasted preserving unused portions.

Secondly, you have to be able to record the number and position of the walls in each cell in order to store the layout of the maze — see figure 2.

We chose to indicate a wall in each direction by the prime numbers 2, 3, 5 and 7. Initially all cells are given a value of 210 — equal to $2 \times 3 \times 5 \times 7$ — which indicates a wall in every direction.

Other possible wall arrangements can be stored as multiples of the relevant prime numbers. For example, a cell with walls only at north and south would be given a value of 14 — equal to 2×7 .

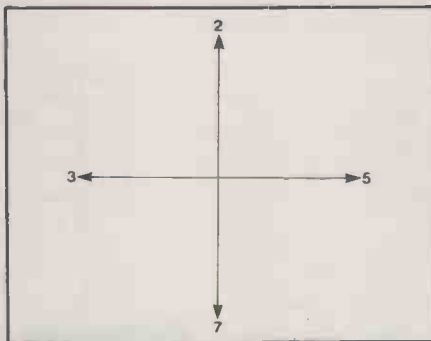
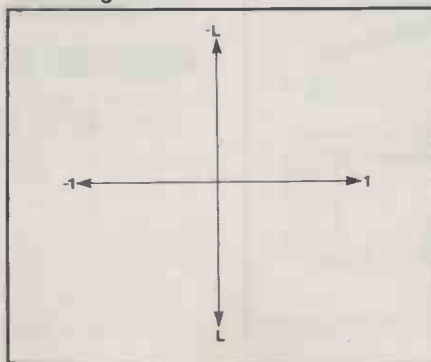

Figure 2a. The four prime numbers which indicate walls W(0) to W(4).

Figure 2b. The change in cell number on moving to a new cell, M(0) to M(3); L is the maze length.



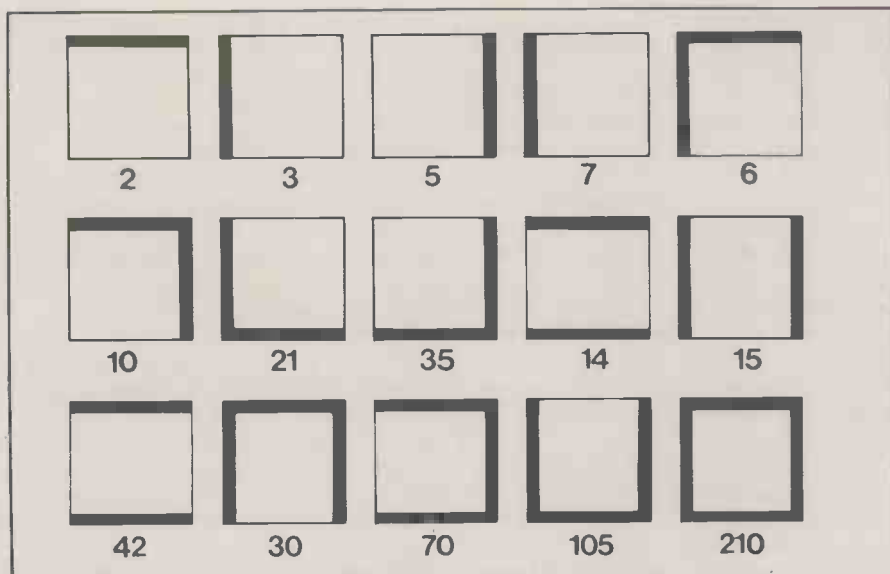

Figure 3. Cell values for each of the possible wall arrangements.

Figure 3 gives all the cell values and the wall arrangements they indicate.

Lines 500 to 595 create the maze. This part of the program is short but not very fast, so the maze is created while instructions are being given in subroutine 900.

Subroutine 900 also carries out the initialisation. Line 950 must be changed: it gives the memory locations of the top left, top right, bottom left and bottom right of the screen memory — TL, TR, BL and BR. It also sets the line length LL, the depth of wall DW, and the cell depth CD.

Obviously LL should be set to the line length of your own micro. The depth of wall DW is the number of pixels to be used to draw each cell wall. The cell depth CD is a necessary limiting factor due to the lack of high resolution on our micro. When a certain number of cells of diminishing size have been drawn to give the illusion of perspective, the centre of the screen is reached. There is clearly no point in trying to go further and attempting to display more cells.

The procedure is easier to follow if you look at the values used in the program. Although the line length LL for the Superboard is 32, the screen memory has an actual line length of 25. With a depth of wall of three, and a cell depth of four,

the maximum possible display of left-handed walls uses four sets of three pixels = 12 pixels. The right-hand walls use another 12 pixels, so the perspective display of four maze cells uses 24 pixels altogether. As the screen has a line length of 25, this leaves a single, blank pixel at the centre of the screen to suggest the limits of vision — see figure 4.

You will have to choose values of DW and CD carefully to get the best display. An important factor to consider is the possible longest length of a corridor in the maze. There is no point in setting CD to 8 if most mazes have dimensions of less than eight cells. The program as written varies the length L and width W of the maze between six and 10 cells. If you want to adjust this, change line 960.

As already stated, all cells are given an initial cell value of 210 to indicate four walls. In early versions of the program the values for each cell were stored in an array. However, each element in an array uses four bytes in the Superboard memory. A 10-by-10 array takes up 400 bytes, which is a large chunk out of a 4K RAM.

As all cell values are 210 or less, they can be Poked as single bytes into memory.

(continued on next page)

Figure 4. Two views down the same 10-cell corridor. In A, the depth of wall, DW, is 3 and the cell depth is 4, which gives a better display than B, where DW = 2.

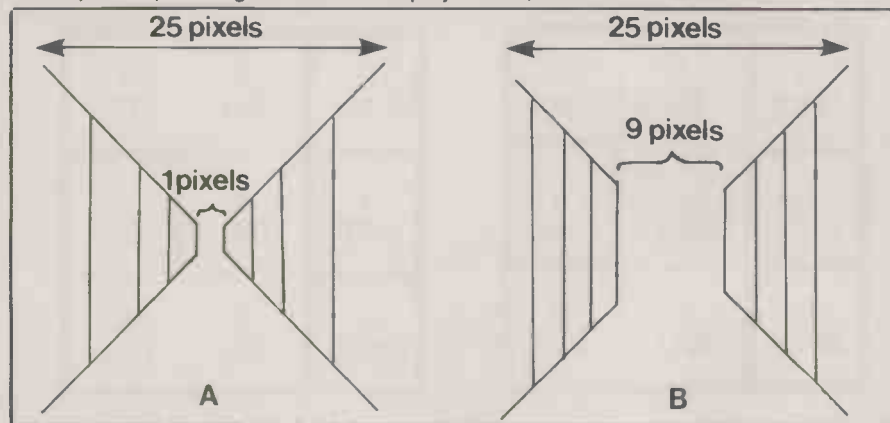

NASCOM/SHARP MZ80K

Pascal for Nascoms and Sharp MZ80K

HiSoft offer a very fast 12K Pascal compiler producing Z80 object code directly i.e. no P-code.

STATEMENTS: CASE .. OF, IF .. THEN .. ELSE, REPEAT .. UNTIL, WHILE .. DO, BEGIN .. END

TYPES: INTEGER, REAL (7 sig. figs.), CHAR, BOOLEAN, ARRAY, SET, COLOUR.

Many standard procedures and functions are supported including trigonometric functions and all procedures and functions may be used fully recursively. The object programs run very fast and require only the runtime routines (4K) to be present.

Price: Nascom Pascal £35
Sharp MZ80K Pascal £37

New Monitor for Nascoms

NASMON is a new 4K monitor incorporating a powerful 'front panel' display of memory, registers and flags together with an extended screen editor. We supply a range of software to run under NASMON; BAS12K, a 12K BASIC interpreter with 11 digit floating point arithmetic, NASGEN, a very fast Z80 assembler, NASDEM, a 2½K disassembler and NASPAS, the 12K Pascal compiler described above.

Prices: NASMON £30
NASGEN in EPROM £25
NASGEN on tape £15
BAS12K on tape £25
NASDEM in EPROM £15
NASDEM on tape £10

Z80 Development Package for Gemini G805 Disk Owners

The package comprises an extended screen editor, a fast Z80 assembler and a debugger with a 'front panel' mode and a Z80 disassembler. All supplied on one 5¼ inch diskette with full documentation. Price £50.

All prices are fully inclusive. Full details may be obtained from:

HISOFT

60 Hallam Moor, Liden, SWINDON, SN3 6LS.

Tel: Swindon 26616

(answering machine service).

● Circle No. 200

Mr. Retailer

The End of Book Keeping

Put your computer on the counter. Enter your sale. Book keeping finished. Your Stock (approx. 1½mm) is immediately adjusted. Enters the sale; deposit, charge account or cash sale. Keeps your VAT (approx. 1½mm) and all books up to date. Records change given and permanently stores. Reminds you of lines due to re-order. In fact does all your book keeping automatically from POINT OF SALE (approx. 2mm). Just imagine, your stock (2½mm) and VAT details automatically updated at time of sale!!! Now a reality. Point of Sale Programme (approx. 2mm). £975 + VAT (approx. 4mm). Counter Top Computer (approx. 2mm) and Printer, complete system including Retailers Point of Sale Programme. £3,590 + VAT (approx. 4mm). Easier to use than an electronic cash register.

Dealerships available.

ACCESS COMPUTERS,
2 Rose Yard, Maidstone, Kent.
Phone: (0622) 58356

● Circle No. 201

ZX81 DATABASE 16K

This is the package that real businessmen are using, and heaping praise upon. Fast m/c code, pleasing menus, flexible search keys. For address lists, stock — any kind of list. Multiple display/print formats. £10 for tape and full doc.

NEW: ZX81 WINDOW DISPLAY system, driven by fast m/c code interpreting high-level 'window' language, as seen at ZX Microfair. Tape and full doc. £7 launch offer.

ZX81 4K DISASSEMBLER £7.
MAGIC CUBE £3.50.

SAE for more details of these and others to:

CAMPBELL SYSTEMS (Dept PC)
15 Rous Road, Buckhurst Hill,
Essex IG9 6BL

● Circle No. 202

ZX81 CASSETTE ONE

- ★ REACT (m/c)
- ★ INVADERS (m/c)
- ★ PHANTOM ALIENS (m/c)
- ★ MAZE OF DEATH (m/c)
- ★ PLANET LANDER (m/c)
- ★ BUG SPLAT (m/c)
- ★ BOUNCING LETTERS (m/c)
- ★ I CHING (basic)
- ★ MASTERMIND (basic)
- ★ BASIC HANGMAN (basic)
- ★ ROBOTS (basic)

PROG OF THE MONTH: MAZE OF DEATH

You are in a maze which contains a monster and an escape point. You are shown the distances to the monster and the escape point, but not their actual positions. Can you reach the escape point before the monster gets you?

All for 1k RAM. All on CASSETTE ONE (sent 1st class) for £3.80 from

MICHAEL ORWIN,
26 BROWNLOW ROAD, WILLEDEN,
LONDON NW10 9QL.
(Quality programs wanted, send SAE for details)

● Circle No. 203

CP/M x.x SOFTWARE

8" single density discs.

RATFOR £35.50
Structured Fortran preprocessor. Requires Microsoft FORTRAN. Source and examples included.

C compiler £35.50
Learn the language of UNIX. Lacks some data types. Many example programs. Requires 40K.

LISP/80 Interpreter £35.50
The Artificial Intelligence language with many examples. Requires 48K.

BOOKS

Software Tools	£8.90
Software Tools in Pascal	£7.90
Lisp	£7.50
C Programming Language	£11.95
ADA Programming Language	£9.50
ADA Programming Structures	£10.90

Add £2 per order p&p. Cheques xPO to:

SYSTEM SCIENCE

54 Enfield Cloisters,
Fanshawe Street, London N1
Tel: 01-739 0540 (evenings)

● Circle No. 204

ALL MICRO DEALERS

£££ NEW SALES OPPORTUNITY £££
INSURANCE BROKER SYSTEM

- Runs on any micro under CP/M & MP/M
- Fully operational for past 12 months
- Numerous systems already installed
- Suitable for all High Street brokers

FOR SALE COMPLETE WITH:—

- Design & Specification
- COBOL Source
- Full Documentation
- Marketing rights

TASK

FORCE TONY MARTIN 0702 515551

● Circle No. 205

(continued from previous page)

Using this technique, a 10-by-10 maze needs only 100 bytes.

You will have to store the maze in an area of RAM unlikely to be taken up by the program. Line 995 gives the memory location SM for the start of the maze. You should change it to a suitable value for your own system.

The remainder of subroutine 900 generates a random starting point P within the maze — line 995 — and also an exit cell EC and a map cell MC — line 1000. In the map cell, the lucky explorer can find a map of the maze with his own position shown by a man — symbol W4 on 955.

The scenario for the game is described in lines 900 to 945. The player has landed on an alien planet while fleeing from enemies, and has sought refuge within the maze. He is wearing a space suit and must find a way out of the maze before his limited oxygen supply expires. The oxygen supply OX plus its rate of loss OL are randomly determined in lines 1010 and 1015. While the player is digesting this information, the maze is created in subroutine 500.

Beginning at the cell P within the maze, the program moves in a random direction. Cells in all four directions are examined successively until an un-visited cell adjacent to the present position is found — lines 510 to 570.

The new cell number is found by adding the correct movement increment M(0) to M(3) — figure 2 — to the present cell number, line 540.

Each time the program moves from one cell to another, the wall in the direction of movement is eliminated by dividing the cell value by the corresponding wall value W(0) to W(3). This operation has to be done twice: the present cell value CP is divided by the appropriate wall number W(A) on leaving the cell; and the cell value after movement CM must also be divided by the number for the wall through which it was entered, line 580. See figure 5 for example.

This random progress through the maze continues until a point is reached

where movement in any direction only leads to cells which have already been visited. In early versions we allowed the program to continue from such a position, but this resulted in mazes consisting mostly of empty spaces.

It might seem that the simplest solution would be to generate a new path from another random cell. However, this neglects the problem of closed circuits already discussed, and the new path might never join the old one.

The best way to ensure that all paths join is to begin any new path from somewhere along the old path. When the program gets stuck in cell P, line 500 increments P and checks whether there is then a virgin cell next to one already visited. If not, it goes back to 500 and increments P again. For example in figure 5 the program will be stuck in cell 5 after the last diagrammed position. Incrementing P gives cell 6, and as this is an un-visited cell adjacent to the path, the new path would begin from cell 7 to cell 6.

Some checks have to be included because certain movements are forbidden at the maze edges. Line 540 guards against moves off the top or bottom row of the maze. Line 570 prevents the program falling off the sides. For example, in figure 5, although adding 1 to the cell is normally allowed, the move from cell 5 to cell 6 is prohibited because 5 is an edge cell.

A count C is kept of the number of cells visited. When all cells have been used in the maze the subroutine terminates.

Between two and three cells per second are generated. On average, a 10-by-10 maze takes about 50 seconds on the Superboard, but the time taken is very variable.

Subroutine 600 draws a map of the maze. To make this as universal as possible the only graphics symbol used here is the one with the whole pixel filled.

A wall in any direction is shown by three of these symbols. Because adjacent cells share a wall in common, the maze in figure 5 would use seven pixels horizontally and seven pixels vertically.

Figure 5. Generation of a maze. In diagram A the program has moved through the cells 2-1-4-7-8. The program can only move to cell 5, as in B, since it must always visit new cells. Cell values are given in brackets.

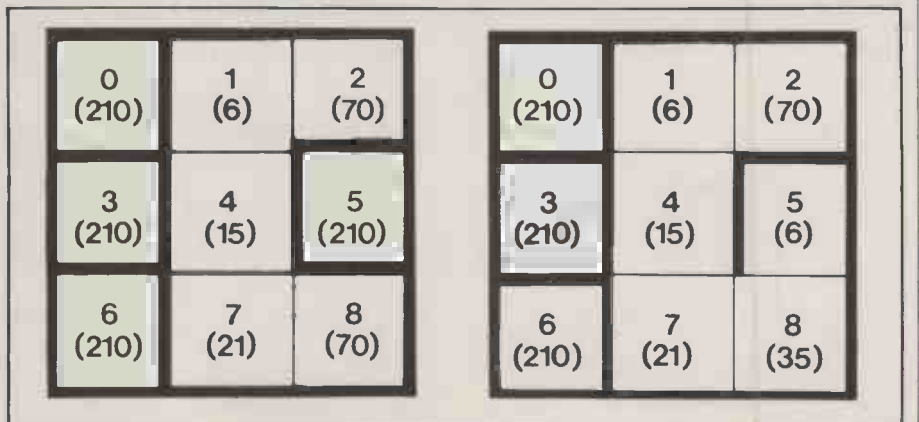

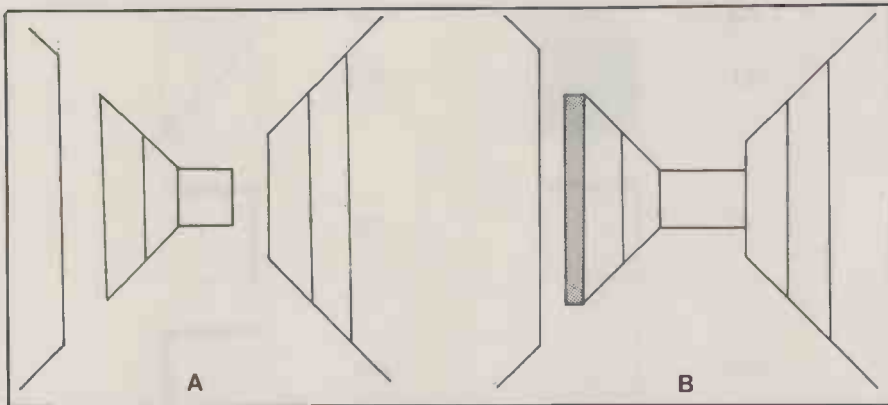

Figure 6. Two views of the same corridor. Display B includes fixes to improve appearance.

The size of the maze that can be displayed obviously depends on the dimensions of your screen display. A maze of side n cells requires $2n + 1$ pixels. The maximum size maze that can be shown with 40 characters per line and 25 lines is 19 by 12.

If you enjoy finding your way through a maze against the clock you can use the subroutines 500 and 600 alone, without the perspective view. You will have to add a few lines to enable you to move within the maze. Your starting point can be cell number zero, and the end cell the last cell, number H.

A large maze takes some time to generate, but there is no need to wait while later mazes are prepared. Once a map of the maze has been displayed, the maze stored in memory is no longer needed. With some re-writing, a new maze can be created while you are finding your way through the one shown on the VDU.

If you have no graphics the maze can still be explored, although it is rather difficult "blind". Each direction of movement $M(0)$ to $M(3)$ is associated with movement through a particular wall $W(0)$ to $W(3)$. If the cell value is divisible by the array value $W(A)$ a wall is present in that direction and movement that way is not possible. Otherwise, with no wall, the cell number is incremented by the array value $M(A)$ and the new cell is entered. Checks for walls are used several times in the program — see lines 105, 120 and 160.

The perspective view is calculated by the subroutine 70 to 110, which also calls the drawing subroutine 10 to 60.

The first cell to be drawn is the one in which the player is currently standing. The left-hand side of the cell is examined first to see if there is a wall present and, if there is, it is drawn — line 100. If there is no wall you will be able to see into the cell on the left. Lines 110, 120 calculate the left-hand cell number and examine that cell for a back wall, such a wall then being drawn if necessary.

The same method is used to show the right-hand side of the cell, but with a few variables changed. There is thus a loop from 80 to 140 which is run through twice, first drawing the left side and then the right side. Line 140 shifts the corners

in, ready for the back wall or the next cell to be drawn.

Once both side walls have been drawn, line 160 checks for a back wall. If no back wall is present, line 170 changes the cell number 0P to that of the next cell in the direction we are looking. This same line also increments the depth-of-cell count DC and checks that this does not exceed the greatest possible cell depth CD.

If at any time a back wall to a cell is found, lines 200 and 210 draw this back wall, and the subroutine ends. Lines 180 to 190 are a fix to improve the appearance when there is a back wall next to a cell with no back wall. Line 20 in the drawing subroutine is another fix which gives a more solid look to walls seen end on. Figure 6 shows the same view with and without the fixes.

Lines 240 to 440 enable the player to explore the maze. At the start, no view of the maze is shown. After a time TT a torch will be found, and thereafter the view will always be drawn. Line 430 clears the screen and calls the drawing, subroutine. During the initial period of blindness it is possible for the space suit to be damaged, in which case the player may suffer a faster rate of oxygen loss, lines 300, 310. The same fate can overtake anyone foolish enough to blunder into a wall which can be seen.

Four commands are available via Input statements or, alternatively, by keyboard control — lines 250, and 320 to 340.

The player may turn right, left or opposite his present viewing position, but he will remain in the same cell — only the view will alter. Movement is always forwards — in the direction the player is currently facing. The commands are abbreviated to R, L, O and M respectively.

The exit cell has no view beyond it if you are looking directly at it. Once you arrive at the exit cell you automatically escape.

Figure 7 lists the graphics symbols used to draw the perspective view. You should make appropriate substitutions in lines 70, 80, 90 and 960.

With our limited memory we were unable to add all the embellishments we

(continued on next page)



OASIS SOFTWARE PRESENT FOR 8K UKIOI OWNERS

ASTEROID TRAVELLER

Asteroid Traveller has been written entirely in fast 6502 code and the graphics are excellent. As well as negotiating oncoming asteroids the player has an alien pursuit ship to contend with. 7 starting levels!

GUIDED MISSILE

Guided Missile is a real time 'Invader' type game and uses machine code subroutines for fast smooth graphics. In this version the user can control his missile toward his target and the game is further enhanced by space debris.

SHEEP DOG TRIAL

A truly new real time game. Sheep Dog Trial is one of the most frustrating games you have ever played. You control the dog, the dog controls the sheep. The idea is to round up the sheep against a countdown which is bumped up on each successful herding. Definitely different!

3D MAZE

Although not real time, the 3D graphics in this game are superb. The player is presented with a birdseye view of the maze itself and simultaneously a view down the corridor he is currently in. Careful thought will find the exit.

All the above are £4.50, or all four for £12.50. Also Golf, Jackpot, Life and Station £4.50. And Rubic Cube simulator and Backgammon £5.50 each.

All Oasis prices include VAT and P&P available from:

Oasis Software, Lower North Street, Cheddar, Somerset.

● Circle No. 206

BOOK-KEEPING for ACCOUNTANTS & TRADERS

Purchases Day Book, Sales & VAT to run on a 32K PET.

Neat, Clear and Comprehensive Print-outs. Error-proof, Fast & Easy to operate. Computes all NINE Retailer Special VAT Schemes.

Box 11 & 12 amounts and End of Year adjustments, etc.

100 Expense analysis + Goods at Zero and Std Rates.

100 Supplier analysis.

Approved by Customs and Excise.

Only £97.75 inc VAT. C.W.O.

Or send £5 for further details and sample printout

E. Stanton MBIM, 86 Bracken Drive, CHIGWELL, Essex M7 5RD.

Tel: 01-500 4318 or 01-505 7830

● Circle No. 207

Quality TRS-80 Software

- THE CUBE — HOW TO DO IT!** Price £10.00
This program will unscramble the Rubik's cube for you. Good graphics plus full instructions enable you to master this puzzle at last.
 - FROG POND.** This a game of logical deduction. The use of excellent graphics plus sound make this program a must for all TRS-80 users. £7.50
 - OTHELLO — also known as REVERSI!** £10.00
Othello is a board game intermediate in difficulty between draughts and chess. 4 levels of play.
 - STARTREK.** Possibly the best version of £10.00 this type of game available; with real-time graphics.
 - THE GREAT RACE.** This is based on a board game and features the added fun of sound effects. £7.50
- All programs run on a 16K Level II Model 1 and is available on tape.
Prices include postage and packaging. Discounts available:— 2 or 3 programs less 5%, 4 or 5 programs less 10%.
- Cheques payable to: **GLENISTER.**
Available from: DEPT PC, 13, PRIDMOUTH ROAD, WITTINGTON, MANCHESTER M20 9GN.

● Circle No. 208

L&J COMPUTERS

192 Honeypot Lane, Queensbury, Middx.
01-204 7525 HA7 1EE

BASIC PROGRAMMING

In response to many enquiries, we are running courses in Basic Programming during this winter. These courses are complete in themselves and comprise 2 evening sessions, each from 6pm to 10pm. Dates available are as follows:

Tuesday/Wednesday 24/25th November 1981
Wednesday/Thursday 9/10th December 1981
Tuesday/Wednesday 12/13th January 1982

The courses are designed as a concentrated teach-in with about 50% of the time being spent on practical work at the keyboard. Syntax, commands, algorithms, flowcharting will be covered.

Price (per 2 evening session) is £40.00 plus VAT (£46.00 INCLUSIVE).

Further information, Programs and Application forms may be had by writing to the above address, or telephoning 01-204 7525 during normal business hours (10am-6pm Mon-Fri: 10am-2pm Sat).

Members will be strictly limited to 10 per session so that the highest ratio of instructors to students can be maintained. Bookings will be made on a first come-first served basis.

● Circle No. 209

SHARP

in SURREY

★ PC 1211 Rocket Computer	£85
★ MZ 80K 20K Computer	£385
★ MZ 80 FD 248 KB Dual Floppy Drives (complete with I/F)	£625
★ MZ 80 P3 Dot Matrix Printer	£360
★ MZ 80 I0 Expansion Unit	£89
★ MZ 80B Scientific/Business Computer	£1,095
★ MZ 80 P5 Hi-Res Graphics Printer	£415
★ MZ 80 FD 1/2MB Dual Floppy Drives (complete with I/F)	£750
★ MZ 80 EU Expansion Unit	£50
★ PC 3201 Complete Business System	£2,995

(PRICES DO NOT INCLUDE VAT)

For further details contact:

SARADAN COMPUTER SERVICES (APPOINTED DEALER)

80 MANOR ROAD, WALLINGTON, SURREY
TELEPHONE: 01-669 9483.

● Circle No. 210

SHARP MZ-80K

NOW AVAILABLE FOR YOUR MZ-80K

JOYSTICK CONTROL (WITH DEMO SOFTWARE AND GAMES)

SPECIAL CHRISTMAS OFFER

GAMES PROGRAMS

BUY TWO — GET ONE FREE

Hardware and business software available

S.A.E. OR PHONE FOR DETAILS

MICROSPEC

143 BALMALLOCH ROAD, KILSYTH G65 9PH
TEL: 0236 621473

● Circle No. 211













Code	Character	Code	Character
161		190	
135		210	
128		207	
136		208	
143		209	
189		240	

Figure 7. Character codes and graphics symbols used in drawing a maze.

(continued from previous page)

would have liked, but here are a few suggestions to improve the basic game:

- Add a monster which pursues the player through the maze. The monster can move at random initially, but if the player does not escape within a certain time limit, it should begin to move faster and more purposefully as it detects an intruder in its lair. Some cells might contain useful objects — if the creature is radioactive its direction could be indicated by a "geiger" compass, and the intensity of radiation could indicate its distance from the explorer.
- One cell could contain a blaster with a limited charge. The blaster could be fired at the monster in a moment of desperation, or it could be powerful enough to demolish one wall of the maze. The demolition is easily accomplished by dividing the cell value by the array value $W(A)$ in the correct direction. A cunning explorer could blast his way out of the maze if he correctly divined that he was near an outer wall.
- Further traps could be set for the unwary. The map drawn by subroutine 600 might be displayed upside down or reversed; minions of the monster could seize an unlucky explorer and delay his escape; some cells in the maze might be entrances to even more dangerous areas.

It is very easy, when entering a program as long as this one, to make a mistake

which becomes difficult to identify. We suggest that you enter this program in sections so that each part can be run to ensure that it is correct. Initially, enter subroutines 500 and 900, and add this line:

```
1029 FOR A= SM TO EM: B=PEEK(A): PRINTB;: NEXTA
```

A series of numbers representing the maze will be printed out: all such numbers should be members of the set shown in figure 3.

Next, add subroutine 600 and the line:
380 GOSUB 600

The maze should be drawn with an exit somewhere along the top. The remainder of the program can now be entered and run.

If you find yourself hopelessly confused and lost after only a few moves, we suggest that you display the map drawn in subroutine 600 at the start, so that you can try to memorise the route out. Line 435 gives the player one look at the map only — it is presumed to be displayed on a VDU which burns out after this brief use. The map can be examined many times if line 435 becomes:

```
IFP=MC THEN GOSUB 600
```

Finally, those with good graphics facilities should be able to draw objects on the floor of a cell. They can be given the correct relative size by referring to the current corner values for the cell, $M(4)$ to $M(7)$. It certainly adds atmosphere if an explorer stumbles across the occasional skull or rib-cage.



```

5 GOTO900
10 Y=PEEK(TC-U):Z=PEEK(TC-U+LL):IFABS(U)=10RDC=0THEN30
20 IFY=32ANDZ=32THENFORA=TC-U+LLTOBC-U+LLSTEP11:POKEA,W3:NEXT
30 POKETC,TW:POKEBC,BW:B=B+1:IFB<DWHENTC=TC+U:BC=BC+U:GOTO30
40 IFABS(U)=1THENPOKETC,T1:POKEBC,B1
50 IFTC=BC-LLTHENRETURN
60 FORB=TC+LLTOBC-LLSTEP11:POKEB,SW:NEXT:RETURN
70 F=ML:U=LL+1:V=1-LL:T1=207:B1=208:SM=143
80 FORX=4TO6STEP2:TW=190:BW=189:B=0:IFX=4THEN100
90 F=MR:U=LL-1:V=-LL-1:SM=136:T1=210:B1=209:TW=189:BW=190
100 LM=M(F):LD=W(F)
101 IFF=3ANDOP=ECTHEN140
105 IF0-LD*INT(Q/LD)=0THENTC=M(X):BC=M(X+1):GOSUB10:GOTO130
110 TW=135:BW=128:U=U-LL:V=U+LL:N=PEEK(OP+LM)
120 IFN-D*INT(N/D)=0THENTC=M(X)+DW*LL:BC=M(X+1)+DW*-LL:GOSUB10
130 IFABS(U)=1THENU=U+LL:V=U-LL
140 M(X)=M(X)+DW*U:M(X+1)=M(X+1)+DW*V:NEXT
150 IFN=3ANDOP=ECTHENRETURN
160 IF0-D*INT(Q/D)=0THEN180
170 OP=OP+M(M):Q=PEEK(OP):DC=DC+1:IFDC<D0THEN70
175 IFDC=D0THENRETURN
180 R=PEEK(M(4)-1)
185 IFR=32THENM(4)=M(4)-1:M(5)=M(5)-1:IFM(4)<>TL+DW*LLTHEN180
190 R=PEEK(M(6)+1)
195 IFR=32THENM(6)=M(6)+1:M(7)=M(7)+1:IFM(6)<>TR+DW*LLTHEN190
200 FORTC=M(4)TOM(6):POKETC,W1:NEXT
210 FORBC=M(5)TOM(7):POKEBC,W2:NEXT:RETURN
240 PRINTOX:" UNITS OF AIR"
245 PRINT"ACTION":INPUTA$
250 NP=P:Q=PEEK(P):IFA$="M"THENNP=P+M(M)
260 IFNP=PTHEN320
270 IFNP=ECTHENPRINT"YOU ESCAPE!":END
285 IF0-D*INT(Q/D)<>0THENNP=NP:PRINT"YOU MOVE":GOTO380
300 IFRND(1)>.9THENPRINT"YOUR SUIT RIPS WHEN ":OL=OL+1
310 PRINT"YOU HIT A WALL":GOSUB3000:GOTO410
320 NM=M:IFA$="R"THENNM=M+1
330 IFA$="0"THENNM=M+2
340 IFA$="L"THENNM=M+3
350 IFNM=MTHEN240
360 IFNM>3THENNM=NM-4*INT(NM/4)
370 M=NM:PRINT"YOU TURN."
380 D=W(M):Q=PEEK(P):OP=P:ML=M-1:MR=M+1
390 IFML<0THENML=3
400 IFMR>3THENMR=0
410 OX=OX-OL:IFOX<0THENPRINT"YOU DIE.":END
420 T=T+1:IFT=11THENTT=1:PRINT"YOU FIND A TORCH":GOSUB3000
430 IFTT=1THENDC=0:GOSUB2000:GOSUB70
435 IFF=MCANDRM=0THENRM=1:GOSUB600
440 M(4)=TL:M(5)=BL:M(6)=TR:M(7)=BR:GOTO240
500 P=P+1:IFP>EMTHENP=SM
510 A=INT(RND(1)*4):DC=0
520 A=A+1:DC=DC+1:IFDC>3THEN500
530 IFA>3THENA=0
540 M=P+M(A):IFM<SMORM>ENTHEN520
550 CP=PEEK(P):CM=PEEK(M):IFC=0ANDCP=210THENP=M:GOTO510
560 TM=M-SM:IF(CP=CMORCM<210)ANDC=0THEN520
570 NE=TM-L*INT(TM/L):IF(NE=0ANDM(A)=1)OR(NE=0ANDM(A)=-1)THEN520
580 OD=INT(15/M(A)):CP=CP/M(A):POKEP,CP:CM=CM/OD:POKEM,CM
590 P=M:C=C+1:IFC<HTHEN510
595 RETURN
600 GOSUB2000:PRINT"YOU FIND A MAP"
605 A=TL:MS=A:DC=SM:DD=SM+6
610 FORB=DCTODD:FORDC=0T03:CB=PEEK(B):CB=CB-W(C)*INT(CB/W(C))
620 AA=1:IFC=10RDC=3THENAA=LL
630 IFC>1THENAA=-AA
640 BB=LL/AA:P2=A+AA:P1=P2+BB:P3=P2-BB
645 IFB=PTHENPOKEA,W4
650 ECB=0THENPOKEP1,W3:POKEP2,W3:POKEP3,W3
660 NEXTC:A=A+2:NEXTB:DC=DC+L:DD=DD+L:A=MS+(2*LL):MS=A
670 IFDC<=EMTHEN610
680 GOSUB3000:RETURN
900 GOSUB2000:PRINT"YOU HIDE IN AN ALIEN MAZE TO ESCAPE ENEMIES."
910 PRINT"FIND THE EXIT BEFORE YOUR AIR RUNS OUT."
950 TL=53349:BL=54149:TR=53374:BR=54174:LL=32:DW=3:CD=4
955 W1=135:W2=128:W3=161:W4=240
960 W(0)=5:W(1)=7:W(2)=3:W(3)=2:L=INT(RND(1)*5+6)
970 M(0)=1:M(1)=L:M(2)=-1:M(3)=-L:M(4)=TL:M(5)=BL:M(6)=TR:M(7)=BR
980 W=INT(RND(1)*5+6):H=L*W-1:G=L-1:C=0:DC=0:T=0:RM=0
995 SM=576:EM=SM+H:FORA=SMTOEM:POKEA,210:NEXT:P=SM+INT(RND(1)*H)
1000 EC=SM+INT(RND(1)*L):MC=INT(RND(1)*H)+SM
1010 OX=INT(H/3)+1:IFF<OXTHENOX=-OX
1015 OX=OX+H:OL=1:TT=INT(RND(1)*H/8)+1:GOSUB500:GOSUB2000
1030 M=0:NP=P:CE=PEEK(EC):CE=CE/W(3):POKEEC,CE:GOTO380
2000 FORX=0T025:PRINT:NEXTX:RETURN
3000 FORX=0T05000:NEXTX:RETURN
    
```

SPECIAL ANNOUNCEMENT for ACORN ATOM owners

PROGRAMMER'S TOOL-BOX

A packed 4K EPROM (fits Utility Socket) containing:
1200 BAUD CASSETTE OPERATING SYSTEM
 Visible Load Routine

PLUS
 *TRACE(X) — controlled execution, line no. display.
 *STEP — single step execution.
 FIND — any string of chars. in program.
 VAR — list variables.
 LVAR — print variables.
 AUTO X,Y — automatic line numbering (any start, any step).
 RENUMBER X,Y — any start, any step.
 DELETE X to Y — any range of line nos. (*VIA chip required).

PLUS Additional BASIC statements
 READ, DATA & RESTORE
 KEY X — scans keyboard-input to variable.
 INKEY \$X — scans keyboard-input to string variable.
 IF ... THEN ... ELSE
 WHILE ... ENDWHILE
 CURSOR X,Y — position cursor as required.
 ON ERROR
 BEEP X,Y — sound a note-any duration, any pitch.
 ZERO — zeros all basic variables.
 POP — close out sub-routine.

Real value at £24.50 + VAT & 25p P & P. Sae for details & cat.

* NASCOM MAGAZINE * "MICRO-POWER"

Series articles, club news, letters & answers. Packed full of useful information. ISSUE 3 NOV. ISSUE 4 DEC. Back copies available. ORDER NOW TO SECURE YOUR COPIES. Only 95p each (incl.)



Send Sae for details & cat.
 5 Wensley Road, Leeds LS7 2LX.
 Tel. (0532) 683186.

● Circle No. 212

SEARCHING FOR 'BEST PRICE' ...

FOUND 'BEST PRICE' ... GOTO

PET	RRP	OUR PRICE
4008N	8K	£450
4016	16K	£550
4032	32K	£695
8032	32K	£895
DISK DRIVES		
4040	343K	£695
8050	1M	£895
PRINTERS		
4022	80COL	£395
8024	132COL	£1160
8026	DAISY	£995

VAT to be added @ 15%
 Carriage — £5 per item

If you know what you want why wait?
 These are the prices you need

ORCHARD COMPUTER SERVICES

Orchard House, 21 St. Martins St., Wallingford, Oxon.
 Tel. Wallingford (0491) 35529
 Open 6 days per week.



● Circle No. 213

TYPE — RIGHT!

Turn your Apple II or ITT 2020 into a professional Word-Processing system with full upper and lower case display and proper shift-key operation. Plug-in fitting, with enable/disable switch, so no conflict with any existing hardware or software. Complete with manual, fitting instructions and software on disk (including Applewriter conversion, etc). £46.50

Just Published!

What's Where in the Apple? An Atlas to the Apple Computer

By William F. Luebbert

Adjunct Professor of Engineering, Dartmouth College
The MOST DETAILED description to date of Apple II Firmware and Hardware.

- This Atlas and Gazetteer of PEEKs, POKEs, and CALLs lists in tabular form over 2000 memory locations.
- Information is presented numerically in the Atlas, and alphabetically in the Gazetteer.
- The names and locations of various Monitor, DOS, Integer BASIC, and Applesoft routines are listed, and information is provided on their use.
- The easy-to-use format includes:
 - The address in hexadecimal (useful for assembly programming): .SFC58
 - The address is signed decimal (useful for BASIC programming): (-936)
 - The common name of the address or routine: [HOME]
 - Information on the use and type of routine: \SE\
 - A description of the routine: .CLEAR SCROLL WINDOW TO BLANKS. SET CURSOR TO TOP LEFT CORNER
- Related register information:(A—Y—REGS ALTERED)

This reference tool offers information every serious Apple user needs. BASIC and assembly language users alike will find the book helpful in understanding the Apple.

128 pages. 8½ x 11 inches. £9.95

JAILBREAK FOR THE ITT 2020

Come out from behind those HI-RES bars. If you have regretted buying the ITT 2020 instead of the APPLE because of the graphics problems, there is now an answer to your problems. You can now run hi-res programs written for the APPLE on an ITT 2020 without the annoyance of the vertical bars. Chess and complex games are a joy to behold.

- ★ No soldering required — fitted in 5 minutes.
 - ★ Switch back and forth between APPLE and ITT 2020 graphics instantly.
 - ★ Compatible with PASCAL and Microsoft Softcard BASIC.
 - ★ Gives 280X192 hi-res screen as opposed to ITT 360X192 dots. Does not affect text or Lo-res graphics.
 - ★ Does not support hi-res colour commands. Generally only suitable for black and white.
 - ★ Works better with APPLESOFT either on a ROM CARD on loaded onto a RAMCARD (e.g. RAMEX CARD).
- JAILBREAK £33
Special offer JAILBREAK and RAMEX CARD for ITT 2020 £125

THE INSPECTOR

The Inspector is a set of utilities which allow you to examine data both in memory and on a disk. This enables you to:

- ★ REPAIR BLOWN DISKS
- ★ SEARCH DISKS OR MEMORY FOR ASCII OR HEX STRINGS
- ★ EDIT DISK SECTORS OR MEMORY
- ★ OUTPUT DISK SECTORS OR MEMORY TO SCREEN OR PRINTER
- ★ NIBBLE READ ROUTINES THE HI-RES
- ★ USER EXIT FOR INTERFACING YOUR OWN ROUTINES

Space is too short to fully describe this valuable facility. You will not know how you managed without it. If you are not convinced send S.A.E. for further details.

If you have INTEGER in ROM you need the ROM VERSION to place in socket DB.

If you have a RAM CARD the INSPECTOR can be merged with INTEGER by means of the DISK VERSION, and it will always be ready when you have booted up your master disk.

THE INSPECTOR ON DISK or ROM £35
THE INSPECTOR PLUS RAMEX RAM CARD £130

All prices inclusive of VAT, Postage, etc.

MICRO SOURCE

1 Branch Road, Park Street,
St. Albans.
Tel: Park Street (0727) 72917

• Circle No. 214

The Type-a-Shape program allows stored shapes to be reproduced in high-resolution by a single command. In the second part of his series on Apple graphics, Roger Cullis explains the program's features.

Automatic shape generation

A USEFUL facility of Apple is the ability to store a collection of shapes and to reproduce them in Hires graphics with a command of the form Draw N AT X,Y where N is the code number of the required shape. A table of up to 255 different shapes may be constructed.

Shape display is virtually instantaneous and so a very complicated graphic could rapidly be constructed using this technique. The method of defining shapes in a shape table is described in detail in the Applesoft Reference Manual, chapter 9. Briefly, each shape is defined as a succession of Move+Plot and Move + No plot vectors. Each vector is represented as a binary number, and groups of three binary numbers are collected together as a hexadecimal byte. A shape definition consists, in turn, as a collection of hexadecimal bytes.

Compiling shape definitions manually is an extremely slow and laborious procedure, but it can easily be achieved by mechanically following a few simple rules. Type-a-Shape uses the procedures developed in the two Type-a-Graphic programs to permit the construction or modification of a shape table using single-key entries to move a cursor to produce a Lores analogue of a Hires shape. A numeric array is used to store the definition temporarily during construction. On completion, the array is converted to a shape definition and added to the shape table before being displayed in Hires format. It can then be modified using the Lores guide matrix on which the Lores analogue of the shape is displayed for guidance.

The general features of Type-a-Shape are similar to those of the previous programs and should be clear from either the program or the flowchart — figure 1. Nevertheless, certain program lines require special explanation.

60 An integer array Byte%(A) is used as a temporary store during construction of the shape definition since this type of array is most economic of memory space. The dimension 200 is considered adequate to store enough vectors to accommodate the most elaborate shape envisaged. Apple stores addresses as a high-order byte and a low-order byte; FN HI(A) and FN LO(A) permit ease of calculation.

1400 When a binary file has been loaded by DOS, locations 43634 and 43635 contain the starting address (for a 48K system — refer to the Apple DOS manual for other memory sizes).

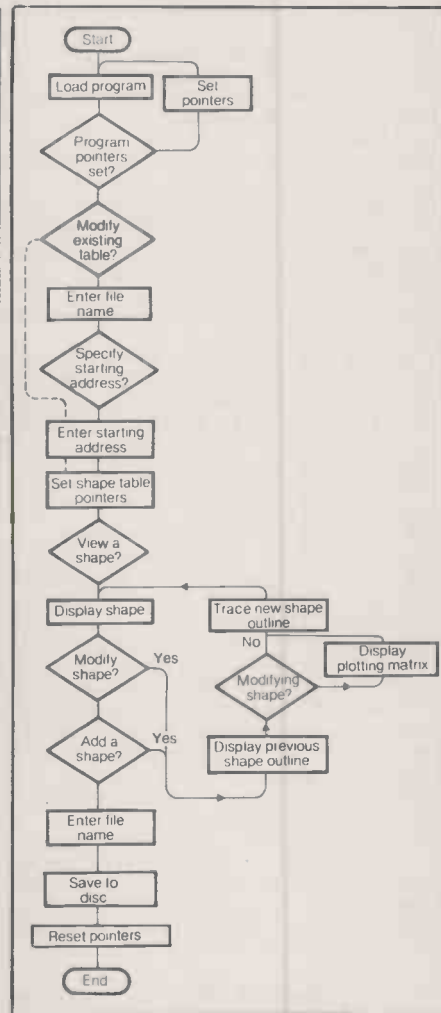

Figure 1. Format of Type-a-Shape program.

1410 Similarly, locations 43616 and 43617 contain the length of the most recently loaded binary file.

1420 The number of shapes in a shape table is stored at the starting address of the table. 5230-5260 A guide matrix of grey and magenta dots is constructed to facilitate drawing the Lores outline of a shape.

5270 AS = "N" is used as a temporary flag to indicate whether a new shape is being defined or a previous shape modified.

5320 The starting address of the definition of an individual shape is stored at locations ST+2*N and ST+2*N+1 where ST is the starting address of the shape table and N is the shape number.

5330 Error routine prevents program crash if the shape definition was not prepared using the Type-a-Shape program.

5340-5550 Binary vectors are derived from the actual shape definition and plotted as coloured pixels on the Lores guide matrix.

5350 A shape definition ends with a zero byte.

5620 K is the number of bytes in a shape definition. R,TR are flags used to compile the array.
 5650-5660 Screen colour is used as a temporary store of Plot/No-plot vectors.
 5820-5860 It is possible to choose a combination of Move/Plot/No-plot vectors which would result in a zero hexadecimal byte and would inadvertently terminate the shape definition.
 5870-6440 correct the situation by going back three moves.
 6060 converts from binary to hexadecimal.
 6090-6100 carry binary vectors to next byte.

6120 inserts a Move/No-plot byte into an otherwise blank shape definition to permit it subsequently to be modified without clobbering the other shapes in the table.
 6160-6350 When a shape definition is modified, the memory space and other shape pointers need to be adjusted to take account of its different length.
 6380 The array is stored as a shape definition in the table.
 6480-6600 When modifying a previous shape it is often convenient to be able to copy portions by using the simplicity of the Trace command.

```

1 REM TYPE-A-SHAPE (SHAPE TABLE COMPILER)
2 REM PROGRAM COMMENCED 28 AUG 1980 IN APFLESOFT BASIC
3 REM LAST AMENDED 03 JUL 1981 (VERSION NO.46)
4 REM COPYRIGHT 1981 - ROGER CULLIS
5 REM THIS PROGRAM PERMITS CONSTRUCTION OF A NEW SHAPE TABLE
6 REM OR MODIFICATION OF AN EXISTING TABLE.
7 REM FOR ADDITIONAL INFORMATION REFER TO APFLESOFT PROGRAMMING MANUAL CH.9
8 REM WRITTEN ON APPLE II WITH LANGUAGE CARD AND 48K MEMORY
9 REM SHAPE ORIGIN IS 0,0 - TO COMPILE TABLE WITH DIFFERENT ORIGIN AMEND LINES 5270,5280
10 D$ = CHR$(13) + CHR$(4): REM CR + CONTROL D
30 IF PEEK(103) = 1 AND PEEK(104) = 64 AND PEEK(16384) = 0 THEN GOTO 60
40 POKE 103,1: POKE 104,64: POKE 16384,0: REM AVOIDS HGR-CLOBBED VARIABLES
50 PRINT D$;"RUN TYPE-A-SHAPE": REM RELOAD ABOVE HGR PAGE 1 MEMORY
60 DIM BYTE$(200): DEF FN LO(A) = A - 256 * INT(A / 256): DEF FN HI(A) = INT(A / 256)
70 H$ = " TYPE 'H' FOR HELP"
997 REM *****
998 REM INSTRUCTIONS AND CONTROL PROGRAM
999 REM *****
1000 HOME : PRINT : PRINT
1010 PRINT TAB(8)"*****:"
1020 PRINT TAB(8)"* *:"
1030 PRINT TAB(8)"* TYPE-A-SHAPE *:"
1040 PRINT TAB(8)"* *:"
1050 PRINT TAB(8)"* SHAPE TABLE COMPILER *:"
1060 PRINT TAB(8)"* *:"
1070 PRINT TAB(8)"*****:"
1080 VTAB 12: PRINT " A PROGRAM TO COMPILE SHAPE TABLES FOR R"
1090 PRINT : PRINT "USE WITH HIRES GRAPHICS."
1100 PRINT : PRINT "THE SHAPE DEFINITION IS COMPILED BY"
1110 PRINT : PRINT "MOVING A CURSOR OVER A GUIDE MATRIX"
1120 PRINT : PRINT "DISPLAYED IN LORES GRAPHICS. NEW SHAPE S"
1130 PRINT : PRINT "MAY BE ADDED TO A TABLE AND EXISTING"
1140 PRINT : PRINT "SHAPES ALTERED."
1150 FOR I = 0 TO 7000: NEXT :I = 0: REM DISPLAY TIME
1160 HOME : VTAB 10: PRINT "DO YOU WISH TO MODIFY AN EXISTING SHAPE"
1170 PRINT : PRINT "TABLE (Y/N?)"
1180 GET B$: IF B$ = "N" THEN GOTO 1340
1190 IF B$ < > "Y" THEN GOTO 1180
1197 REM
1198 REM ERROR ROUTINE
1199 REM
1200 ONERR GOTO 1220: REM IF "FILE NOT FOUND"
1210 GOTO 1270
1220 HOME : VTAB 10: PRINT "FILE - "NAME$" - NOT AVAILABLE
    
```

(continued on next page)



ADVENTURE GAMES

MACHINE CODE PROGRAMS FOR THE UK01 OR SUPERBOARD WITH ANY MONITOR

1. NEW YORK SUBWAY/TROLL'S TUNNEL (£5.50)
Overcome the trolls, stone giant, and many other monsters to escape from an underground prison.
2. ZOMBIE FOREST/VAMPIRE CASTLE (£5.50)
Survive the servants of the Evil One, and rid the forest of its dark curse.
3. KY, TEMPLE OF THE DRAGONKING (£5.50)
With strong shield and pulsating sword, slay the dragon and liberate your people.

EACH ABOVE PACK HAS TWO 8K PROGRAMS

4. ALIEN ADVENTURE 16K (£6.00)
Your spacecraft is stranded on an asteroid in deep space. Escape is possible, but not easy.

TWO OR MORE PACKS - LESS 20%

From Mr M Perkins, 290 Station Road, Stechford, Birmingham B33 8QR

Circle No. 215

VIDEO MONITORS AND KEYBOARDS

£39.50 PLUS VAT

PLUS CARRIAGE £7.50

Secondhand factory reconditioned 9" video monitors — fully tested but unguaranteed. Composite video input 0.5 — 2.5 volt peak to peak, amplifier response + 4db at 10 MHz. Complete with circuit and instructions.

Separate secondhand matching keyboards £21.75 plus VAT, carriage £3.50

BOX NUMBER P.C.200, QUADRANT HOUSE, THE QUADRANT, SUTTON, SURREY SM2 5AS.

Circle No. 216

APPLE II SOFTWARE

SPECIAL OFFERS FOR CHRISTMAS 1981

GERMAN WHIST — the popular card game presented in high resolution graphics. A real challenge of skill and concentration ... £8.50

ALIEN TYPHOON — the successor to Apple Galaxian, the space invader game to beat them all ... £13.00

CRANSTON MANOR — become the hero in this latest On-line adventure game, searching the dilapidated manor for hidden treasure ... £17.00

DEMON DERBY — avoid collisions with your kamikaze rival as you steer your car around a multi-lane racetrack ... £12.00

GALAXY WARS — superb sound effects accompany you as you steer missiles through showers of meteorites and enemy fire ... £12.00

RASTER BLASTER — the most realistic hi-res simulation of them all. This is pinball, written by Bill Budge, the animation king ... £15.00

SNOGGLE — formerly Puckman, and a well-known arcade game. Steer yourself at speed around a maze, chased by hungry ghosts ... £12.00

SPACE EGGS — space monsters in ovo hover overhead. Break open their shells, and the fight is on ... £13.00

WARP FACTOR — a special Christmas present for Star Trek fans. Assume the role of Commander and go where no man has gone before ... £24.00

MAGIC WINDOW — the friendly word processing package, with which you may enter, save and print letters, lists, catalogues, or even your first novel ... £59.00

VISIDEX — the superb electronic card filing system which enables you to retrieve information with consummate ease ... £99.00

Please add 50p P&P to orders below £25.00, and VAT at 15%

Write or telephone for free catalogue and price list to:

OOCC SOFTWARE
13 Hawthorn Grove, Wilmslow, Cheshire SK9 5DE
Wilmslow 524228

Circle No. 217



Brilliantly simple

On our launch we are pleased to offer you

£1350 OF FREE MICROCOMPUTER

software and services which includes: Incomplete Record/Book-keeping/Financial Accounting and Payroll, General Data Management, Invoicing, Letter Writing or Word Processing systems and one day training with first 50 ADLER-ALPHATRONIC MICROCOMPUTERS sold at £2,345 each, leasing from £15.60 a week excluding VAT.

Please telephone for a demonstration to **Watford 48580.**

OVERSEAS COMPUTER SYSTEMS CONSULTANTS

182a, Queens Road, Watford.

● Circle No. 218

MICROCASE

"turns a board into a real computer"

For **NASCOM 2**
COMPUKIT
SUPERBOARD
ALSO UN CUT FOR **NASCOM 1**
ETC.

Direct from us or from your dealer — but make sure you see a

GENUINE MICROCASE

SIMPLE SOFTWARE LTD
15 HAVELOCK ROAD
BRIGHTON, SUSSEX BN1 6GL
(0273) 504879



● Circle No. 219

TRS-80 A/D CONVERTER BOARD

2 or 4 analogue input.
2 x flag input. Includes P.S.U. and connector for TRS-80. Just plug in and go; software included.
2 input £39.50 — Uncased; £55.00 — Cased
4 input £44.00 — Uncased; £57.00 — Cased

Add VAT CWO P&P £2.00.

Also **FLUKE METERS 'B' SERIES** AVAILABLE FROM £75.00.

T. GARLAND & SON LTD.,
14A Kenworthy Lane, Northenden,
Manchester M22 4EJ.

● Circle No. 220

(continued from previous page)

```

1230 PRINT : PRINT "PLEASE CHECK SPELLING AND DISK CATALOG
"
1240 PRINT : PRINT "DO YOU WISH TO RE-ENTER FILE NAME (Y/N
?)"
1250 GET A$: IF A$ = "N" THEN B$ = "N" GOTO 1480
1260 IF A$ < > "Y" THEN GOTO 1250
1267 REM
1268 REM LOAD SHAPE TABLE
1269 REM
1270 HOME : VTAB 10: PRINT "ENTER SHAPE TABLE NAME,"
1280 PRINT : PRINT "THEN PRESS 'RETURN'"
1290 PRINT : INPUT " ";NAME$
1300 PRINT : PRINT "DO YOU WISH TO SET THE"
1310 PRINT : PRINT "STARTING ADDRESS (Y/N?)"
1320 GET A$: IF A$ = "N" THEN GOTO 1380
1330 IF A$ < > "Y" THEN GOTO 1320
1340 HOME : VTAB 10: PRINT "ENTER STARTING ADDRESS OF SHAP
E TABLE"
1350 PRINT : INPUT "THEN PRESS 'RETURN' - ";ST$:ST = VAL
(ST$)
1360 IF B$ = "N" THEN GOTO 1470
1370 PRINT D$;"BLOAD "NAME$", A"ST: GOTO 1390
1380 PRINT D$;"BLOAD "NAME$
1390 POKE 216,0: REM RESET ERROR MESSAGE FLAG
1400 ST = PEEK (43634) + 256 * PEEK (43635): REM STARTIN
G ADDRESS OF TABLE
1410 LE = PEEK (43616) + 256 * PEEK (43617): REM LENGTH
OF TABLE
1420 TN = PEEK (ST): REM NUMBER OF SHAPES IN TABLE
1430 HOME : VTAB 10: PRINT NAME$
1440 PRINT : PRINT "THIS TABLE CONTAINS "TN" SHAPES, START
S"
1450 PRINT : PRINT "AT "ST" AND IS "LE" BYTES LONG."
1460 GOTO 1490
1467 REM
1468 REM NEW TABLE
1469 REM
1470 LE = 512: REM SPACE FOR 255 SHAPE ADDRESS POINTERS
1480 A$ = "Y": ROT = 0: N = 0: REM INITIALISE
1490 POKE 232, FN LO(ST): POKE 233, FN HI(ST): POKE ST + 1
,0: REM SET SHAPE TABLE POINTERS (E8,E9)
1500 HIMEM: ST - 1: REM PROTECT TABLE
1510 IF B$ = "N" THEN GOTO 1750
1517 REM
1518 REM VIEW A SHAPE
1519 REM
1520 PRINT : PRINT "DO YOU WISH TO VIEW ANY SHAPE (Y/N?)"
1530 GET A$: IF A$ = "N" THEN GOTO 1650
1540 IF A$ < > "Y" THEN GOTO 1530
1550 PRINT "ENTER SHAPE NUMBER, THEN PRESS 'RETURN'"
1560 INPUT "N = ";N$
1570 N = VAL (N$): IF N < 1 OR N > TN THEN PRINT "SHAPE N
"N" DOES NOT EXIST": GOTO 1550
1577 REM
1578 REM DETERMINE SHAPE LENGTH
1579 REM
1580 IF N = PEEK (ST) THEN K = LE - PEEK (ST + 2 * N) -
256 * PEEK (ST + 2 * N + 1): GOTO 1600
1590 K = PEEK (ST + 2 * N + 2) - PEEK (ST + 2 * N) + 256 *
(PEEK (ST + 2 * N + 3) - PEEK (ST + 2 * N + 1))
1600 GOSUB 6410: REM DRAW HGR SHAPE
1610 PRINT : PRINT "DO YOU WISH TO CHANGE THIS SHAPE (Y/N?
)"
1620 GET A$: IF A$ = "Y" THEN A$ = "N": GOTO 1700
1630 IF A$ = "N" THEN PRINT : PRINT "DO YOU WISH TO VIEW
ANOTHER SHAPE (Y/N?)" : GOTO 1530
1640 GOTO 1620

```



```

1650 PRINT : PRINT "DO YOU WISH TO ADD ANOTHER SHAPE (Y/N?
)"
1660 GET A$
1670 IF A$ = "Y" THEN N = PEEK (ST): GOTO 1750
1680 IF A$ < > "N" THEN GOTO 1660
1690 GOTO 8000
1697 REM
1698 REM CHANGE A SHAPE
1699 REM
1700 GOSUB 5000: REM  COMPILER SHAPE DEFINITION AND DISPLA
Y
1710 PRINT : PRINT TAB( 18)"OK (Y/N?)": GET A$
1720 IF A$ = "Y" THEN A$ = "N": GOTO 1630
1730 IF A$ = "N" THEN GOTO 1700
1740 GOTO 1710
1747 REM
1748 REM ADD A SHAPE
1749 REM
1750 N = N + 1: COUNTER = 0: POKE ST, N
1760 ADDRESS = ST + 2 * N: POKE ADDRESS, FN LO(LE): POKE AD
DRESS + 1, FN HI(LE): REM  SAVE CURRENT SHAPE POINTERS

1770 GOSUB 5000: REM  COMPILER SHAPE DEFINITION AND DISPLA
Y
1780 PRINT : PRINT TAB( 18)"OK (Y/N?)"
1790 GET A$: IF A$ = "Y" THEN LE = LE + K: TN = N: GOTO 165
0
1800 IF A$ = "N" THEN N = N - 1: GOTO 1750
1810 GOTO 1790
4997 REM *****
4998 REM COMPILER SHAPE DEFINITION AND DISPLAY
4999 REM *****
5000 IF T = 1 THEN GOTO 5210: REM  INSTS. ALREADY LOADED
INTO P2 BUFFER?
5010 TEXT : HOME : PRINT TAB( 14)"INSTRUCTIONS"
5020 PRINT : PRINT " THE SHAPE DEFINITION IS COMPILED BY"
5030 PRINT "MOVING A CURSOR ON A LORES GRAPHICS"
5040 PRINT "GUIDE MATRIX. DIFFERENT COLOURS ARE"
5050 PRINT "USED FOR 'PLOT' (ORANGE) AND 'NO-PLOT'"
5060 PRINT "(BLUE) MOVES. BROWN AND DARK BLUE"
5070 PRINT "DEPICT THE CORRESPONDING VECTORS OF A"
5080 PRINT "PREVIOUSLY DEFINED SHAPE."
5090 PRINT : PRINT TAB( 16)"COMMANDS"
5100 PRINT : PRINT "I J ) MOVE THE CURSOR POSITION (I-UP,
"
5110 PRINT "K M ) J-LEFT, K-RIGHT, M-DOWN)"
5120 PRINT : PRINT "P ) SELECT 'PLOT' VECTOR"
5130 PRINT "D ) SELECT 'NO-PLOT' VECTOR"
5140 PRINT : PRINT "T ) TRACE PREVIOUS SHAPE"
5150 PRINT : PRINT "S ) STOP, COMPILE AND DISPLAY SHAPE
"
5160 FOR I = 2048 TO 3023: POKE I, PEEK (I - 1024): NEXT
5170 VTAB 24: PRINT TAB( 8)"PRESS 'RETURN' TO CONTINUE"
5180 GET C$: IF C$ < > CHR$( 13) THEN GOTO 5180
5190 FOR I = 3024 TO 3071: POKE I, PEEK (I - 1152): NEXT
5200 T = 1
5207 REM
5208 REM PREPARE LORES GUIDE MATRIX
5209 REM
5210 GR
5220 HOME : VTAB 21: PRINT TAB( 15)"SHAPE # " N
5230 POKE 35, 23: VTAB 24: PRINT H$: VTAB 22
5240 COLOR = 5: FOR LI = 0 TO 39: VLIN 0, 39 AT LI: NEXT : REM
PLOTING GUIDE
5250 COLOR = 3: FOR LI = 9 TO 39 STEP 10: VLIN 0, 39 AT LI: HLIN
0, 39 AT LI: NEXT
5260 COLOR = 0: FOR LI = 0 TO 38 STEP 2: VLIN 0, 39 AT LI: HLIN
0, 39 AT LI: NEXT

```

(continued on next page)

EXIDY 56K

RAMPAC — Just plug in our new RAM-PAC and your 48K Exidy will become a 56K super machine. Special Offer £84.95.

EXMEM — upgrades 32K Model I to 48K, £84.95.

WESTON MICROTECHNOLOGY LTD.

Weston House, 12 Alma Rd, Monkstown, Co. Dublin, Ireland

● Circle No. 221

We buy 2nd hand micros — personal or business systems

We sell refurbished micros for personal or business use

We offer maintenance contracts on most makes of micros

We repair systems too!

Ring day or night

Recordawell Limited

Bedford (0234) 61426

● Circle No. 222

UNIVERSITY OF CAMBRIDGE ELECTRONIC ENGINEERS/PHYSICISTS

There are two vacancies for RESEARCH ASSISTANTS in the field of electronic instrumentation with particular emphasis on micro-processors and computer interfacing:

1. Development of electronic systems associated with new electron and ion-beam instruments for X-ray and mass spectroscopy.
2. With the Marine Geophysical Group on development of a new underwater seismic recorder and similar instruments. Software development experience would be particularly valuable in this post.

Appointments will be for a period of three years with a salary in the range £5680-£8575 according to age and qualifications.

Applications, including a full curriculum vitae and names of two referees, should be sent as soon as possible to: The Secretary, Bullard Laboratories, Department of Earth Sciences, Madingley Rise, Madingley Road, Cambridge.

● Circle No. 223

DIAMOND SOFTWARE

Latest games programs for APPLE, i.e.,

PUCKMAN	£13.95
EPOCH	£20.95
GAMMA GOBLINS	£15.95
AUTOBAHN	£15.95
APPLE GALAXIAN	£13.95
ALIEN TYPHOON	£13.95
GALAXY WARS	£13.95
SPACE EGGS	£15.95
PHANTOMS FIVE	£15.95
PULSAR II	£15.95
JOYSTICKS	£19.00
GAME I/O EXPANDA PORTS	£9.00

Full list of products available from

DIAMOND SOFTWARE

Clayton Holt End, Underhill Land, Clayton, Hassocks, West Sussex BN6 9PL.

● Circle No. 224



MICROSOURCE is a new concept, specialising in utilities for the APPLE & ITT 2020. New, because as users ourselves, we know what you need and so are in the unique position of being able to offer expert advice. We can thoroughly recommend the products below, either we use them ourselves, or have had them specially written to fill a need. We will gladly supply more information and answer your specific enquiries.

RAMEX CARDS £95

The only RAM Extension card for the APPLE which does not involve pulling chips out of the mother-board. In combination with your System Master Disk, you can now have the equivalent of an Integer or Applesoft ROM card, as well as being ready for PASCAL. Compatible with Z80 card, Visicalc, The MILL 6809 card, etc, etc.

PROGRAM LINE EDITOR £22

Gives you the editing facilities APPLE left out. You can now insert / delete / find / display normal and control characters in lines without having to copy the whole line. No more spaces in strings or fiddling with the cursor keys. With the added bonus of defining your own commands through the ESC key. Cuts down your mistakes and saves you time.

OMNIFONT £27

A set of programs which allows you to use your EPSON printer to produce hard copy using ANY of the fonts in the DOS 3.3 TOOLKIT. Use the ones provided or define your own from BASIC or even from APPLEWRITER. Use all the facilities of your EPSON (including enlarge, enhance and underline) with APPLEWRITER.

OMNIDIS £22

Accesses both 3.2 and 3.3 disks - *Automatically*. Uses no extra memory. Solves all the problems of having to Muffin and DeMuffin files. Also includes utilities to personalise your disks, alter DOS commands and protect your disks from copying.

SCREEN-WRITER £37

The program for the APPLE owner wishing to use the computer for advertising purposes. It allows you to set up a changing display on the screen in various character sets and colours, in upper and lower case to advertise or inform. Compatible with Versawriter.

APPLEPLOT CONVERTER £10

Allows you to print the graphs on an EPSON printer in all modes. (Graphics facilities must be present on the printer).

SUPER-VADERS £17

A totally new version of the ever popular game.

ABC = Apple Bit Copier £60

This disk allows you to make back up copies of most disks including the copy protected ones.

VISICALC BACK-UP £16

Allows you to make a back up copy of your Visicalc disk. Please specify 3.2/3.3 DOS.

RELOCATED INTEGER £16

Allows you to run any Integer program without the expense of a language card, including those using Hi-res graphics. Mini-assembler included. Specify memory size and DOS 3.2/3.3.

AUTO-INDEX £18

Allows you to make a Master Catalog disk, with fully automatic updating, and comprehensive search and sorting routines. Requires 48K and disk. Specify DOS 3.2/3.3.

GAMES EXPANSION PORT £11.50

Forget having to take the lid off every time you want to change paddles for other accessories. Run two sets of paddles.

DISK DRIVE EXPANSION PORT £22

Do you remove your disk controller cards when you transport your APPLE? Wouldn't it be easier just to unplug them from this handy extension port without removing the lid.

BENEATH APPLE DOS £11.95

This book is a goldmine of information on how DOS works, what it does and where all the locations are for the various routines.

DOS-SWITCH £11.95

Are you fed up of having to boot a 3.3 disk and use BOOT13 or to use your BASICS disk to boot a 3.2 (13 sector disk) or had trouble with the games you bought in 3.2 DOS which will not boot. The answer is to fit this switch, which will allow you to boot a 3.2 DOS disk directly, or switch back to a 3.3 DOS boot mode. Fits onto the disk controller card. Fitted in minutes.

WANTED * * * WANTED * * * WANTED * * * WANTED

Have you written some software which wants someone to market it for you? Have you a piece of **HARDWARE** which we could market? Have you the ability to turn an idea into reality? We can supply the ideas both in software and hardware. Can you supply the necessary skill and time? Do you have a problem in either software or hardware which we can solve for you? If so write to us at the address below.

DEALERS please ask for terms.

All prices inclusive of VAT, Postage, etc.

MICROSOURCE

1 Branch Street, Park Street,
St. Albans.
Tel: Park Street (0727) 72917.

● Circle No. 225

(continued from previous page)

```

5270 COLOR= 7: IF A$ = "N" THEN X = 0:Y = 0: GOTO 5320
5280 X = 0:Y = 0: REM START AT ORIGIN
5290 IF SCRN( X,Y) = 2 THEN COLOR= 7
5300 IF SCRN( X,Y) = 8 THEN COLOR= 9
5310 GOTO 5620
5320 ADDRESS = ST + PEEK( ST + 2 * N) + 256 * PEEK( ST +
1 + 2 * N)
5330 ONERR GOTO 5560: REM IF SHAPE EXTENDS BEYOND PLOTTI
NG MATRIX
5340 BYTE = PEEK( ADDRESS)
5350 IF BYTE = 0 THEN GOTO 5280
5360 M1 = BYTE - 8 * INT( BYTE / 8): REM SEPARATE INTO MO
VES
5370 BYTE = INT( BYTE / 8)
5380 M2 = BYTE - 8 * INT( BYTE / 8)
5390 BYTE = INT( BYTE / 8)
5400 M3 = BYTE
5410 M = M1: GOSUB 5480: REM FIRST MOVE
5420 IF M2 = 0 AND M3 = 0 THEN GOTO 5460
5430 M = M2: GOSUB 5480: REM SECOND MOVE
5440 IF M3 = 0 THEN GOTO 5460
5450 M = M3: GOSUB 5480: REM THIRD MOVE
5460 ADDRESS = ADDRESS + 1
5470 GOTO 5340
5480 IF M < 4 THEN COLOR= 2: GOTO 5500
5490 M = M - 4: COLOR= 8
5500 PLOT X,Y
5510 IF M = 0 THEN Y = Y - 1
5520 IF M = 1 THEN X = X + 1
5530 IF M = 2 THEN Y = Y + 1
5540 IF M = 3 THEN X = X - 1
5550 RETURN
5560 PRINT "SHAPE POSITION DOES NOT CORRESPOND WITH"
5570 PRINT "LORES PLOTTING MATRIX."
5580 PRINT "COMMENCE PLOTTING AT ORIGIN."
5590 FOR I = 0 TO 1000: NEXT
5600 POKE 216,0: REM RESET ERROR FLAG
5610 A$ = "Y": GOTO 5210
5617 REM
5618 REM COMPILE TEMPORARY STORAGE ARRAY
5619 REM
5620 K = 1: COUNTER = 0: R = 0: TR = 0: REM INITIALISE
5630 P1 = 0: P2 = 0: P3 = 0: M1 = 0: M2 = 0: M3 = 0
5640 PLOT X,Y
5650 IF SCRN( X,Y) = 9 THEN P = 1
5660 IF SCRN( X,Y) = 7 THEN P = 0
5670 GET A$
5680 IF A$ = "I" AND Y > 0 THEN M = 0: Y = Y - 1: GOTO 5780
5690 IF A$ = "K" AND X < 38 THEN M = 1: X = X + 1: GOTO 578
0
5700 IF A$ = "M" AND Y < 38 THEN M = 2: Y = Y + 1: GOTO 578
0
5710 IF A$ = "J" AND X > 0 THEN M = 3: X = X - 1: GOTO 5780
5720 IF A$ = "P" THEN COLOR= 9: GOTO 5640
5730 IF A$ = "I" THEN COLOR= 7: GOTO 5640
5740 IF A$ = "T" THEN GOSUB 6480: IF TR = 1 THEN TR = 0: GOTO
5780
5750 IF A$ = "S" THEN R = 1: GOTO 6050
5760 IF A$ = "H" THEN GOTO 6610
5770 GOTO 5670
5780 COUNTER = COUNTER + 1
5790 IF COUNTER = 1 THEN P1 = P: M1 = M: GOTO 5640
5800 IF COUNTER = 2 THEN P2 = P: M2 = M: GOTO 5640
5810 IF COUNTER = 3 THEN P3 = P: M3 = M
5820 IF P3 = 1 OR P3 = 0 AND M3 = 0 THEN COUNTER = 4: P1 =
P3: M1 = M3: P3 = 0: M3 = 0: GOTO 5840

```



```

5830 GOTO 6060
5840 IF P2 = 0 AND M2 = 0 THEN COUNTER = 5:PS = P2:MS = M2
: GOTO 5860
5850 GOTO 6060
5860 IF P1 = 0 AND M1 = 0 THEN PRINT "ILLEGAL MOVE TERMIN
ATES CURRENT SHAPE.": PRINT "RE-ENTER LAST THREE MOVES
.": GOTO 5880: REM AVOID ZERO BYTE
5870 GOTO 6060
5877 REM
5878 REM GO BACK 3 MOVES
5879 REM
5880 IF (X + 1) / 10 = INT ((X + 1) / 10) OR (Y + 1) / 10
= INT ((Y + 1) / 10) THEN COLOR= 3
5890 IF X / 2 = INT (X / 2) OR Y / 2 = INT (Y / 2) THEN
COLOR= 0: GOTO 5910
5900 COLOR= 5
5910 PLOT X,Y
5920 IF M3 = 0 THEN Y = Y + 1
5930 IF M3 = 1 THEN X = X - 1
5940 IF M3 = 2 THEN Y = Y - 1
5950 IF M3 = 3 THEN X = X + 1
5960 IF (X + 1) / 10 = INT ((X + 1) / 10) OR (Y + 1) / 10
= INT ((Y + 1) / 10) THEN COLOR= 3
5970 IF X / 2 = INT (X / 2) OR Y / 2 = INT (Y / 2) THEN
COLOR= 0: GOTO 5990
5980 COLOR= 5
5990 PLOT X,Y:Y = Y + 1
6000 IF (X + 1) / 10 = INT ((X + 1) / 10) OR (Y + 1) / 10
= INT ((Y + 1) / 10) THEN COLOR= 3
6010 IF X / 2 = INT (X / 2) OR Y / 2 = INT (Y / 2) THEN
COLOR= 0: GOTO 6030
6020 COLOR= 5
6030 PLOT X,Y:Y = Y + 1
6040 COLOR= 7:COUNTER = 0: GOTO 5640
6047 REM
6048 REM CONVERT FROM PSEUDO-BINARY TO HEX
6049 REM
6050 IF P1 + P2 + P3 + M1 + M2 + M3 = 0 THEN GOTO 6120
6060 BYTEX(K) = M1 + 4 * P1 + 8 * M2 + 32 * P2 + 64 * M3
6070 COUNTER = COUNTER - 3:K = K + 1: IF R = 1 THEN GOTO 6
130
6080 HOME : VTAB 21: PRINT "SHAPE "N" CONTAINS "K" BYTES S
O FAR"
6090 IF COUNTER = 2 THEN M2 = MT:P2 = PT:M1 = MS:P1 = PS
6100 IF COUNTER = 1 THEN M1 = MT:P1 = PT
6110 GOTO 5640
6120 IF K = 1 THEN BYTEX(K) = 1:K = K + 1
6130 BYTEX(K) = 0:KN = K
6140 POKE 35,24: REM RESET TEXT WINDOW
6150 HOME : VTAB 21: PRINT "SHAPE # "N" CONTAINS "K" BYTES
"
6157 REM
6158 REM ADJUST MEMORY SPACE
6159 REM
6160 IF N > PEEK (ST) - 1 THEN GOTO 6360
6170 KO = PEEK (ST + 2 + 2 * N) + 256 * PEEK (ST + 3 + 2 *
N) - PEEK (ST + 2 * N) - 256 * PEEK (ST + 1 + 2 * N)
6180 IF KN = KO THEN GOTO 6360
6190 HOME : VTAB 22: PRINT "LOADING REVISED SHAPE INTO MEM
ORY"
6200 A1 = ST + PEEK (ST + 2 * N + 2) + 256 * PEEK (ST + 2
* N + 3) + KN - KO
6210 LE = LE + KN - KO: REM NEW LENGTH OF SHAPE TABLE
6220 A2 = ST + LE
6230 IF KN < KO THEN GOTO 6280
6240 FOR ADDRESS = A2 TO A1 STEP - 1
6250 POKE ADDRESS, PEEK (ADDRESS + KO - KN)
6260 NEXT ADDRESS
6270 GOTO 6310
    
```

(continued on next page)

'SIMPLY WRITE'

Super word processor at a silly price!



All you'd expect for ten times the price. PLUS re-define keyboard, graphics printing, tape or disk files, old or new ROMs, PET or ASCII printers, AND 40 or 80 column (same tape or disk). We didn't believe it either! £37 tape (can save to disk); £40 disk (sample files etc). Manual £1 refundable. Specify drive.

and now...
'SIMPLY FILE': information manager (DBMS) to match!

Robust, versatile, self-calculating, economic back-up. £65 disk only, with manual. Manual £1 refundable. Specify drive.

LIGHT PEN + SOFTWARE — plug in & go. £22
PROGRAMMER'S TOOLKIT — makes programming less like work! 3.0: £28. 4.0 (incl 80): £30.

ADVENTURE 1 & 2: authentic Scott Adams 24K classic games. Each £7 (both, £13)

NEW! ASTEROIDS-81 — fast action. £6

Add VAT to all prices please, but post/insurance included. Unconditional Instant Refund Guarantee on hardware, also software if not up to description. Write for more details, more items, newsletter.

SIMPLE SOFTWARE LTD.,
15 Havelock Road,
Brighton, Sussex BN1 6GL
(0273) 504879



● Circle No. 226

NEED A COMPUTER SHOP IN YOUR AREA

and Always felt you could run one of your own

But worried about going it alone?

Nationally accepted Micro computer outlet offers limited number of individually tailored franchises to enthusiast amateurs, to cater particularly for the personal computer market. Capital required in the region of £10,000 to include stock.

Convince us why you could succeed in your area.

Box 200

● Circle No. 227

VIDEO GENIE 32K MEMORY EXPANSION UNIT

An attractive metal cased unit measuring 302 x 84 x 210 mm which plugs into the Video Genie expansion connector.

Provision has been made for adding extra facilities, with space for a further five of our modules and two spare 34-way gold-plated edge connectors. A printer interface and 16K EPROM option will be available shortly.

32K Memory Expansion Unit £160 + VAT

Quote Model No. 32-113 and send your remittance to:

CAVERN ELECTRONICS

94 Stratford Road, Wolverton

MILTON KEYNES MK12 5LU

Tel: 0908 314925

● Circle No. 228



TRS 80 MODEL 1

BARGAIN Super Mods:

- Improved Power Supply designed to run cooler with inbuilt fuse £ 8.00
- 50% Speed Upgrade — Switch selectable — designed to increase clock speed from standard 1.77MHZ to 2.66MHZ £ 9.00
- TRS 80 to Centronics/Anadex Interfaces (from Keyboard) £20.00
- TRS 80 to RS232C Serial Interfaces (from Keyboard) £20.00
- Disk Cables 1/2/3/4 way respectively £3/5/7/9.00

ABOVE PRICES INCLUDE VAT AND POSTAGE/PACKING

Telephone orders accepted - VISA, ACCESS

JOHNSON MICROCOMPUTERS,
75/79 PARK STREET, CAMBERLEY, SURREY
Telephone: Camberley (0276) 20446

● Circle No. 229



**QUME
EPSON
ANADIX
DYSAN**

All Business Applications
Full Personal Attention

Hugh S. O'Neill Computers
111 High Street, Selsey,
CHICHESTER, SUSSEX.
Tel. Selsey (024361) 5856

● Circle No. 230

CONVERT YOUR 16K TRS-80 TO 48K . . . YES 48K

- Latest USA Product easily installed in Keyboard.
- Type I + 16K RAM £69
 - Type II + 16K RAM £98
 - Type II + 32K RAM £117
- 10 day Cash Refund if not delighted.
6 month Warranty.
"Add on" items due soon include Disc Controller, Printer Port, RS 232 Interface and 80-column driver.

SPECIALISED SOFTWARE

- INDEX . . . Name & Address List using Newdos Variable Length Files. Amazing. £15
 - INVOICE . . . General purpose Invoicing Prog which can be linked with INDEX. £15
 - ADMOVE . . . Transfers Adventures to Disk. Listing £1
 - CONV . . . Converts Dec. Hex & Binary — all at once. £5
 - VERBATIM D/D Diskettes. £27.50 for 10
- Small stock of secondhand Games.

SAE for Information & Lists to:
**MICROTRADING POST, NORTON STREET,
NOTTINGHAM.**

● Circle No. 231

Acorn Atom

- ATOM INVADERS 12K, Gr.4 £8.00
- PINGBALL 6K, Gr.2 £4.50
- ATOM BREAKOUT 4K, Gr.1 £4.00
- FRUIT MACHINE 8K, Gr.2 £4.00
- STAR TREK 12K, F.P. £5.00
- DISASSEMBLER 2K £4.00
- JFO BOMBER 7K £4.00
- LABYRINTH 12K, Gr.2A, F.P. £6.95
- LUNAR LANDER 12K, Gr.4 £5.50
- BACKGAMMON 7K £7.00
- GOLF 7K, F.P. £5.00
- TYPIST 7K £4.00
- LAST RUN 7K £3.00
- WIGGLE + RHINO 10K £5.00
- SQUARES + SIMON + PARACHUTE 8K £5.00
- MINI-BREAKOUT + MINI-INVADERS 2K £4.50
- STATISTICS (4 programs) 12K £20.00
- 2114L MEMORY CHIP £2.00
- C12 CASSETTE £0.70

ORDER NOW FOR CHRISTMAS

BUG-BYTE

Microcomputer Software
98-100 THE ALBANY OLD HALL STREET
LIVERPOOL L3 9EP
ALL PRICES GIVEN ARE INCLUSIVE

● Circle No. 232

(continued from previous page)

```

6280 FOR ADDRESS = A1 TO A2
6290 POKE ADDRESS, PEEK (ADDRESS + KO - KN)
6300 NEXT ADDRESS
6310 FOR NI = N + 1 TO TN
6320 ADDRESS = PEEK (ST + 2 * NI) + 256 * PEEK (ST + 2 *
      NI + 1)
6330 ADDRESS = ADDRESS + KN - KO
6340 POKE ST + 2 * NI, FN LO(ADDRESS): POKE ST + 2 * NI +
      1, FN HI(ADDRESS)
6350 NEXT NI:NI = 0
6357 REM
6358 REM STORE DEFINITION
6359 REM
6360 ADDRESS = ST + PEEK (ST + 2 * N) + 256 * PEEK (ST +
      1 + 2 * N) - 1:K = 0
6370 ADDRESS = ADDRESS + 1:K = K + 1
6380 POKE ADDRESS, BYTEX(K)
6390 IF BYTEX(K) = 0 THEN GOTO 6410
6400 BYTEX(K) = 0: GOTO 6370: REM HOUSEKEEPING
6410 HGR
6420 HOME : VTAB 21: PRINT "ENTER SCALE, THEN PRESS 'RETUR
      N'"
6430 INPUT "S = ";SC$
6440 SC = VAL (SC$): IF SC < 0 OR SC > 255 THEN GOTO 6420
6450 ROT= 0: SCALE= SC: HCOLOR= 3: DRAW N AT 180,80
6460 HOME : VTAB 21: PRINT TAB( 5)"SHAPE # "N" CONTAINS "
      K" BYTES"
6470 RETURN
6477 REM
6478 REM TRACE PREVIOUS SHAPE
6479 REM
6480 IF Y = 0 THEN GOTO 6500
6490 IF SCRN( X,Y - 1) = 8 OR SCRN( X,Y - 1) = 2 THEN M =
      0:Y = Y - 1: GOTO 6560
6500 IF X = 39 THEN GOTO 6520
6510 IF SCRN( X + 1,Y) = 8 OR SCRN( X + 1,Y) = 2 THEN M =
      1:X = X + 1: GOTO 6560
6520 IF Y = 39 THEN GOTO 6540
6530 IF SCRN( X,Y + 1) = 8 OR SCRN( X,Y + 1) = 2 THEN M =
      2:Y = Y + 1: GOTO 6560
6540 IF X = 0 THEN GOTO 6560
6550 IF SCRN( X - 1,Y) = 8 OR SCRN( X - 1,Y) = 2 THEN M =
      3:X = X - 1
6560 IF SCRN( X,Y) = 8 THEN COLOR= 9: GOTO 6600
6570 IF SCRN( X,Y) = 2 THEN COLOR= 7: GOTO 6600
6580 HOME : VTAB 21: PRINT "CURSOR IS NOT ADJACENT PREVIOUS
      S SHAPE."
6590 PRINT "USE OTHER PLOTTING KEYS.": RETURN
6600 PLOT X,Y:TR = 1: RETURN
6607 REM
6608 REM DISPLAY TEXT P2
6609 REM
6610 POKE - 16303,0: POKE - 16302,0: POKE - 16299,0: REM
      TEXT,ALL,P2
6620 GET A$: IF A$ < > CHR$( 13) THEN GOTO 6620
6630 POKE - 16304,0: POKE - 16301,0: POKE - 16300,0: REM
      GRAPHICS,MIXED,P1
6640 GOTO 5670
7997 REM *****
7998 REM SAVE ROUTINE
7999 REM *****
8000 TEXT : HOME : VTAB 10
8010 PRINT "ENTER SHAPE TABLE NAME,": PRINT
8020 PRINT "THEN PRESS 'RETURN'": PRINT
8030 INPUT "":NAME$
8040 PRINT D$;"BSAVE "NAME$", A"ST", L"LE
8050 POKE 103,1: POKE 104,8: POKE 16384,255: REM RE-SET P
      ROGRAM POINTERS

```

BUYERS' GUIDE

Printers

The Peripherals Buyers' Guide is a survey of printers suitable for small computers. We have excluded any system which costs significantly more than £2,000. The printers are listed in alphabetical order. The addresses of the main suppliers are listed at the end of the guide.

Printers may be divided into several categories. The highest-quality printing is produced by the daisywheel-type which creates text in various type-faces, according to the wheel used. The quality ranges from excellent typing to rather poor book printing and generally there is a proportional-spacing facility. Those machines tend to be expensive and slow. Daisywheels can be either plastic — inexpensive, but must be replaced often — or metal — expensive but durable.

For faster printing, you must turn to dot-matrix machines. The print quality tends to be poor and the machines noisy. Older machines use a 7-by-5 matrix which puts the descenders of letters such as 'y' above the line. That makes bulk text difficult to read. Better printers use a matrix nine dots deep to give true descenders. Recently, several firms have produced dot-matrix printers which give an approximation to typewriter printing and proportional spacing. They are less expensive than daisywheel machines, work faster and could well be used for correspondence-quality work.

Some dot-matrix printers employ sensitised paper to produce printing by more direct electrical effects. They are often quiet and fast, but the paper can be expensive, unpleasant to handle and hard to obtain.

The trend is to build more processing power into printers. That means they offer increasingly varied features, so it is hard to categorise them precisely.

A printer has to be connected to the computer by a cable and a more or less standard interface. The normal interfaces are the Centronics parallel, RS232 serial port — also known as the V-24 — and 20mA current loop. IEEE is a parallel interface used by Pet; 'cpl' means characters per line, 'cps' means printing speed in characters per second. Allow five characters to the word.

The more intelligent printer prints as its head moves in both directions across the paper — bi-directional printing. Still more



PUT YOUR MICRO TO WORK!

CONTROL MACHINES, ROBOTS, FACTORY OR HOME

Have you ever wanted your MICRO to control a machine for you, or manage your house? If so the MDR 'MICROCOMPUTER CONTROL INTERFACE' will give you isolated channels of OUTPUT (8A @ 250 volts) and switch sensing INPUTS.

Available now for connection to PET USER PORT, RS232 and IEEE488, allowing expansion up to more than 900 channels.

Supplied complete with connecting cables, full data and guarantee from £12.54 per channel. Complete preprogrammed systems or individual components available. Write or phone for details.

MDR (INTERFACES)

Little Bridge House, Dane Hill, Nr. Haywards Heath, Sussex RH17 7JD. Telephone: 0825-790294

● Circle No. 233

Apple Distributors

Commodore Commercial Systems Dealers

Largest stocks in Eastern Counties. Numerous printers, mini, 8" and hard discs.

Software for all business uses — Micro Modeler, integrated Pascal Accounting Systems, Exclusive Estate Agency Systems and Clients Accounting Systems, Farmplan, etc.

OPENING SALE OF COMMODORE PRODUCTS

AT LEAST 10% OFF ALL ITEMS IN STOCK TO CALLERS. We are making a ONCE ONLY offer on Commodore Products on current stocks of at least 10%.

20% Discount on Apple Manuals in stock.

ESTATE COMPUTER SYSTEMS
30 Carre St., Steaford, Lincs.
Tel: 0529-305637

● Circle No. 234

UK101 SOFTWARE ON TAPE

from the guy who wrote "La Passe Temps"
GALACTIC HITCHHIKER (8K) An Adventure, all in machine code. A beauty! (£7.00)
SUPERTREK (8K) Sail boldly through the universe zapping moving Klingons in real time. Superb graphics. (£7.00)
LUNAR LANDER A real challenge. You won't get down in less than three hours. (£3.00)
LE-PASS-TEMPS This is what a computer game SHOULD be like (£3.00)
STARTREK (8K) The old favourite, beautifully presented. Not real time but great graphics nonetheless (£6.00)

* NEW *

Please phone for details of the exciting range of TAQWA ADD ONS:

Others available include a BASIC TUTOR (8 x 4K Programs) £12.00 and lots more games.

Each program comes on its own cassette by return 1st Class Mail. Available for 16 x 48 or 32 x 48 display and compatible all monitor ROMs. All inclusive from:

A. KNIGHT (DEPT PC)
28 SIMONSIDE WALK, ORMESBY, CLEVELAND
Tel: (0642) 321266

● Circle No. 235



DISKS DISKS DISKS

LOWEST PRICES FOR THE BEST

Boxes of 10 mini disks (5.25")

MEMOREX

S/S — S/Density S/Sector £16.30
D/S — D/Density S/Sector 20.80

VERBATIM DATALIFE

Single or Double Density

S/S — S/Sector (40 TR Cert) 17.15
D/S — S/Sector (40 TR Cert) 25.84
D/S — S/Sector (77 TR Cert) 27.30

BASF

S/S — S/Density S/Sector 17.15
S/S — D/Density S/Sector 20.65
D/S — D/Density S/Sector 25.41
Diskette drive head cleaning kit 16.30

— Add £1/box & 15% VAT on total —

PINNER WORDPRO

34 Cannonbury Avenue, Pinner,
Middx., HA5 1TS.
Telephone: 01-868 9548 anytime.

● Circle No. 236

APPLE

WITH

TABS

Sales
and Service
for Business Systems
in Hampshire & Sussex

ACCESS CONTROL SYSTEMS LTD

72 WINCHESTER ROAD PETERSFIELD, HANTS.
TEL: 0730 5274

● Circle No. 237

TRS 80 and GENIE Owners

Now available in UK Cload Magazine.
America's monthly program tape for games
orientated people. Why pay higher prices
when each month you can receive a cassette
with at least 6 programs?

Our latest issue includes:-

Trolls Treasure (Adventure Program);
Croton Diversion (Arcade game with sound);
Banner (Scrolls 2in letters on screen);
Edit (Full screen editor);

PLUS 3 other programs 1 for disc users (all
programs for Model 1, most for Model 3).

Single cassette £4.95.

6 month subscription £25.

12 monthly subscription £47.50.

Post your cheque to:-

MICRODEAL, 44 Corn St., Bristol 1.
Tel: 0272 276769

● Circle No. 238

ACORN ATOM UTILITY ROM

Upgrade your Atom now! Our 4K ROM simply
plugs into the spare socket and provides 18
new commands and utilities including:
renumber, range delete, find, auto line
numbers, program compression, dis-
assembler, true keyboard scanning, memory
dump, variable dump, and much more.
Supplied with full instruction manual. To order
send cheque/PO for £35 inclusive (delivery 1
week) or SAE for further details.

WILLOW SOFTWARE
PO BOX 6, CREDITON, DEVON EX17 1DL.

● Circle No. 239

intelligent ones end the head movement at the ends of short lines. These two features can more than treble the working speed.

Printers use two types of paper: plain paper fed — like a typewriter — pinch- and pin- or sprocket- or tractor-fed with holes along the margins. That paper can be supplied fan-folded or in rolls.

Pinch feeding is more expensive but is convenient for letters. Only a few machines will accept both pinch- and pin-fed paper. It is possible to obtain headed letter paper bonded lightly on to pin-fed, fan-folded computer paper for word processors.

Some printers allow direct control of the print-head to give graphics. KSR means keyboard, send and receive, ASR means automatic send and receive, RO means receive only. KSR machines can be used as electric typewriters in local mode.

Comb or line printers have a whole line's worth of dot hammers so they can print a line of text at a time. They tend to be very expensive and very noisy but produce an enormous quantity of work.

ADDMASTER

400 receive only

Uses 2.5in. Tally roll paper, 16 cpl, 48 cps. Main U.K. agent Clary Ltd.

£242

420/426 receive only

Dot matrix grade-one Tally roll paper at £5 for 20 rolls. BCD serial or 10-line serial interfaces, 12 cpl, 36 cps.

£246

ANADEx

Main U.K. agent Anadex Ltd

DP-500

Dot matrix, tractor feed, parallel interfaces, 18 cpl, 45 cps.

from £367

DP-660

Dot matrix, pinch feed for printing labels, uses sprocket feed. Parallel interface. 19 cpl, 57 cps.

from £700

DP-750A

Dot matrix, RS232C 20mA current loop, 21 cps, 25 cps.

from £800

FP-600

Dot matrix ticket or form printer, from four columns to 19 columns parallel interface, 19 cpl, 44 cps.

from £65

DP-9500 Series

Dot matrix, tractor feed, nine-wire print head, bi-directional printing, three ASCII interfaces as standard — parallel bit, RS232C, current loop — 120-200 cps, 132-220 columns, 7x9, 9x9 or 11x9 matrices depending on model. Also from: Peripheral Hardware, Kode Services, Robox, Stack Computer Services and Data Design Techniques Ltd.

£895 upwards

DP-8000

Dot matrix, pinch feed, bi-directional printing, fan-fold paper up to 9.5 in. up to three copies. Three ASCII interfaces — parallel bit, RS232C, current loop — 112 cps, 80 column, 9x7 matrix. Also from: Peripheral Hardware, Kode Services, Robox, Stack Computer Services and Data Design Techniques Ltd.

£550

DP-1000 Series

Dot matrix, tractor feed, internal data storage, roll-type paper for 40 columns at £11 for box of 10 rolls, three basic ASCII-compatible interfaces are available. 40 cpl, 50 cps, 40 columns, 5x7 matrix. Also from: Peripheral Hardware, Kode Services, Robox, Stack Computer Services.

from £395



AXION CORPORATION

Main U.K. agent Memec Systems Ltd

EX-820 receive only

Electro-sensitive dot matrix includes plotting capability for full graphics, paper at £3 for a 240ft. roll, RS232C or 20mA serial and ASCII parallel, 20/40/80 cpl and up to 160 cps, 5x8 matrix.

£500

EX-850 Video Printer

Electro-sensitive dot matrix, aluminised paper at £3 for a 240ft. roll. Needs only the video signal from user's. Normal resolution 13.5 seconds per screen, high resolution 27 seconds per screen.

£500

EX801/802 receive only

Electro-sensitive, dot matrix, aluminised paper at £3 for a 240ft. roll, RS232C, Centronics, Apple, Pet, and Tandy interfaces, 20/40/80 cpl, 160 cps, 5x8 matrix.

£279

BASE 2

800-MST

Impact dot matrix, bi-directional, tractor feed up to 9.5in., RS232C, 20mA, IEEE-488, Centronics and parallel interfaces, up to 132 cpl and 60 cps, with 5x7 matrix. Main U.K. agents Microbyte and Maclin-Zand Electronics Ltd.

from £385

CENTRONICS

Main U.K. agents Sintrom Distribution, ITT Electronic Services, Cable and Wireless, Dacoll Engineering.

Models 700, 701, 702 and 703

Impact dot matrix, uses fan-fold paper, parallel, serial RS232C interfaces 132 cpl, up to 180 cps, 5x7 or 7x7 matrices.

P.O.A.

Model 791

Demand-document printer, impact, dot matrix, up to 12-part forms using bottom feed tractor, standard parallel interface, with serial RS232C interface option, 80 cpl, 60 cps, 5x7 matrix.

P.O.A.

Model 730

Impact, dot matrix, uses roll paper up to 8.5 in. wide, fan-fold paper up to 9.5 in. wide and cut sheet up to three-ply paper and two carbons, parallel-standard interface with serial RS232 option, 80 cpl, 100 cps, 7x7 matrix. Also from: Datac Ltd, Rair Ltd, Comma Computers and MIBF.

£375

Model 737

Impact dot matrix, roll fan-fold or cut sheet paper, standard parallel interface, serial RS232C option, 80 cpl mono-spaced mode, 50 cps mono-spaced mode, 80 cps proportional mode, 7x8 matrix mono-spaced, 9x9 proportional. Also from: Datac Ltd.

£425

Model PI Microprinter and Model SI Microprinter

Non-impact dot matrix electro-sensitive uses aluminium-coated paper roll, parallel interface, serial RS232C interface, up to 80 cpl, and 150 lines per minute, up to 200 cps. Also from: Datac Ltd.

P.O.A.

Model 780

Impact, dot Matrix, pinch-roll paper feed for roll paper, tractor-feed option for rear- and bottom-feed forms and fan-fold paper, parallel interface with serial RS232C option, 80 cpl, 60 cps, 5x7 matrix.

P.O.A.

Model 779

Impact, dot matrix, pinch-roll paper feed for roll paper, with fan-fold, tractor feed option, standard parallel interface with RS232C serial option, 80-132 cpl, 60-110 cps, 5x7 matrix.

P.O.A.

Model 704

Impact, dot matrix, uses fan-fold paper, RS232 serial interface, 132 cpl, 180 cps using 7x7, 9x7 and 9x9 matrices.

P.O.A.

Model 761 read only or keyboard send/receive

Impact, dot matrix, uses fan-fold paper, RS232C/CCITT V24 or DC current loop interfaces, 132 cpl, 60 cps, 7x7 matrix.

P.O.A.

TRS-80 MODEL I ENHANCED VIDEO

- * TANDY COMPATIBILITY mode (default) gives lower case without the need for switches.
- * FULL MODE gives the FULL CHARACTER SET in POSITIVE and INVERTED VIDEO and all graphics characters.
- * WHOLE SCREEN INVERSION including borders is independently controllable.

Double width capability is not affected. Mode selection by port FE. Fits inside the keyboard case.

Technical manual with software patches £6. Assembled and tested PCB, 2102 chip £23. Parts and manual ordered together £26.45. The above prices include worldwide postage and United Kingdom VAT. Dealer discounts. Installation available, please enquire.

RHA (MINISYSTEMS) LTD., 83 GIDLEY WAY, HORSPTH, OXFORD OX9 1TQ. Tel: 08677-3625

● Circle No. 240

MICROTEXT MAIL SHOT/ WORD PROCESSOR FOR CBM/PET

£35 + VAT

Microtext is a small text processor/mail shot program. It allows mail shots of up to 100 letters per run, and can handle documents of up to 7 pages of A4. It is very simple to use — you can be producing letters etc. within the hour.

Data can be stored on cassette or disk.

Available for 3032/4032/8032, state type and delivery medium required (cassette, 4040 or 8050 disk). £35 + VAT (total £40.25) inc P & P. Dealers — P.O.A.

MAYSTAR MICROSYSTEMS LTD.,
56 College Road, Reading, Berkshire RG6 1QB.
Tel: (0734) 65827

● Circle No. 241

The Concise English Spellguard™

Spellguard™: the ultimate in spelling correction programs. Use it with WordStar™, Magic Wand™, Electric Pencil™... Unfortunately it has an American Dictionary. Now WordPerfect can supply an English version of the 20,000 word dictionary. This is available on 8" standard, single sided, single density diskette or 5" Horizon double sided diskette (CP/M™).
Price: £52.50 including postage and packing. Also: 10,000 word computing and electronics dictionary: £47.50
Please make cheque/P.O. payable to

WordPerfect

Computer Services (Cambridge)

3 Spurgeons Avenue, Waterbeach, Cambridge CB5 9NU
Telephone (0223) 861804

● Circle No. 242

PET/CBM in Lancashire

MEMORY UPGRADE for large keyboard PET
8K up to 32K.
£65 (inclusive).

No extra charge if expansion area drilled with quarter-inch holes.

EPROM PROGRAMMING from data on cassette or ROM 2716 or 2532.
£3 (inclusive).

Repair of PET computers.
Write or phone for further details.

WINDMILL ELECTRONICS

197 Victoria Road East, Thornton,
Blackpool FY5 3ST.
Telephone: (0253) 869108.

● Circle No. 243



Computer Junk Shop

We Buy, Sell, Break
Computers and Peripherals

Surplus Stock

New and Used Power
Supplies To Most Specifications

Always Available

10, Waterloo Road,
Widnes, Halton, Cheshire. WAB 0PY
Telephone : 051 420 4590

● Circle No. 244

SHUGART

MINI FLOPPY DISC DRIVES

** THE LOWEST PRICES ANYWHERE **

SA 400 5¼" £105

BRAND NEW — 3 MONTH LABOUR
& PARTS WARRANTY.

Also available Tandon TM100 — 1 drives

ENCOTEL SYSTEMS LTD
530 PURLEY WAY, CROYDON, S7
01-686 9687

● Circle No. 245

BASIC

Learn how to write computer programs in your spare time. Practical courses will be run at a weekend. Courses will begin early in the New Year.

For further details ring 051-227 5622/3 or write to us at:

MARCH ASSOCIATES LTD
21-23 Old Hall Street,
Liverpool L3 9BT

● Circle No. 246

Floppy Disc File

Easy reference filing system for your flexible computer discs, files 20 discs per binder. File sheets retail 4 discs, have reinforced binder edge and file reference tab. Leaves punched for 2 and 3 hole binders. Also available for 8" discs, files 10 discs per binder. Please state size when ordering.

Binder complete with 5 leaves

£4.95 + VAT

Pack of 5 leaves only

£1.55 + VAT

LEICESTER COMPUTER CENTRE LTD.

Z67 Regent Road, Leicester, LE1 6YF.
Tel: 0533 556268

● Circle No. 247

COMMODORE

CBM 3022

Tractor-feed printer, uses fan-fold paper with three-in. to 12in. width, cost of paper £10 per roll, 1,000, IEEE interface, 80 cpl, 150 cps, 6x7 matrix. Main U.K. agent Davinci Computers Ltd.

£425

COMPUTER DEVICES INC

Miniterm 1201, 1202, 1203

Thermal mechanism, uses Thermal Type B paper at £2.40 per roll, RS232 or parallel — 1201 only — interfaces, 80 or 132 cpl, 10/30 cps, 7x5 matrix. Main U.K. agent Teleprinter Equipment Ltd.

from £936

DATA C

Main U.K. agent Datac Ltd

414 free-standing assembly receive only

Electro-sensitive, matrix printer type 245L, electro-sensitive roll paper, 59mm. wide x 30m. long at 90p per roll for 20 off, six-bit parallel ASCII, character serial interfaces, 16, 20, 32 or 40 cpl, 32 to 80 character per serial, 7x5 matrix.

£130

DMI-40P free-standing terminal, receive only

Impact, matrix, uses pressure-sensitive roll paper, 10mm.-wide ordinary paper version, using ink ribbon. Cost of paper £1 per roll, seven-bit parallel ASCII, character serial, RS232C or graphics, 40 or 20 cpl, up to 80 cps, 7x5 matrix.

£350

411C compact panel mounting, receive only

Electro-sensitive matrix type 245L or R, uses electro-sensitive roll paper, 59mm. wide x 30m. long at 90p per roll, six-bit parallel, serial interfaces, 16, 20, 32 or 40 cpl, 32 to 80 cps, 7x5 matrix.

£209

411 panel mounting, receive only

Electro-sensitive matrix printer type 245L or R, uses electro-sensitive roll paper, 59mm. wide x 30m. long at 90p per roll. Interfaces include six-bit parallel ASCII, character serial, four-bit parallel BCD, character parallel EIA/RS232C, CCITT/V24 and 20mA current loop, under development 40 cpl, 32 to 80 cps, 7x5 matrix.

£189

313 panel-mounting, receive only and

312 free-standing, receive only

Impact matrix type PU-1100, Tally roll paper, 59mm. wide x 36m. long at 60p per roll, CCITT/V24 or EIA RS232C or 20mA current loop interfaces, up to 20 cpl and up to 36 cps, 7x5 matrix.

£269

412/1 and 412/5 receive only

Electro-sensitive dot matrix type 245L, uses electro-sensitive aluminium-coated paper, 59mm. x 30m. at 90p per roll, six-bit parallel, ASCII, character serial and four-bit parallel BCD, character parallel, RS232C/V24 interfaces, 20mA current loop under development, 16, 20, 32 or 40 cpl, 32-80 cps, 7x5 matrix.

£255

522/1 and 522/4 receive only

Impact matrix type, roll paper, 114mm. x 75m. up to three copies plus original, cost of paper £1.10 per roll. Parallel interface and RS232C, 20mA current loop and parallel buttered, asynchronous interfaces — (522/4). 40 cpl, 100 cps instantaneous rate, 33 cps average rate — including CR and LF. 7x5, 7x10.

£499 (522/1)

£535 (522/4)

DATA DYNAMICS

Main U.K. agent Data Dynamics Ltd

303 Printer

Dot matrix, up to six-part stationery width from 3m to 15.375in., V24/RS232C, 20mA current loop, 132 cpl, 30 or 60 cps, 7x7 matrix.

£980

ZIP ASR/K7 twin cassette

Dot matrix format, uses standard Teletype roll paper, V24, RS232C, or 20mA current loop operating at half or full duplex, 80 cpl, 10 or 30 cps switch selected, 5x7 matrix.

£2,000

ZIP 30 keyboard printer, RO, ASR, or KSR

Dot matrix, standard roll paper, 20mA half or full duplex current loop or V24 RS232C, 80 cpl, 10 or 30 cps — switch selected, 5x7 matrix.

ASR £1,800
RO & KSR
£950

390 eight-level and 392 five-level

ASR, KSR and read-only versions. Impact printers, friction or sprocket feed, 8.5in. paper with roll diameter 5in. 74 or 86 cpl, 6.6 or 10 cps.

ASR from
£1,250
LSR from £900
RO from £800

Models 32 and 33 page printers

Available in ASR, KSR and receive-only versions. Friction or sprocket feed, 20mA or 60mA parallel, up to 86 cpl, 6.6 or 10 cps.

ASR from
£1,100
KSR from £800
RO from £700

DATA GENERAL CORPORATION

Dasher TP1 Printer models 6040 and 6041

6040 standard keyboard and can be used as a typewriter. 6041 is a receive-only terminal printer without keyboard, 30 or 60 cps, switch selectable, EIA-RS232C interfaces, 5x7 dot matrix. Main U.K. agent Data General.

From £1,598

DATAPLUS

400 series receive-only Model 480

Impact dot matrix, uses standard Tally roll, up to 3.75in. side, from 80p per roll, RS232C, V24, 20mA current loop, but parallel IEEE, Pet and Apple interfaces, 30/40 cpl, 110 cps, 7x5 and 7x10 matrices. Main U.K. agent Dataplus Ltd.

£475

DATASOUTH CORPORATION

DS-180

Impact, matrix printer, uses fan-fold paper, RS232C, current loop, and parallel interfaces, 132 cpl, 180 cps, 9x7 matrix. Main U.K. agent Datatrade Ltd.

£1,360

DIABLO

HY type II receive only

Impact daisywheel plastic or metal print wheel, parallel, interface, 132 10-pitch cpl or 158 12-pitch cpl, 40/45/55 cps. Main U.K. agent Diablo Systems Ltd.

P.O.A.

630 receive only

Daisywheel, metal/plastic printwheels, standard listing or single sheet paper, RS232C, V24 with optional bus interface, 132 cpl at 10 pitch, 158 cpl at 12, 198 cpl at 15, up to 40 cps with automatic bi-directional printing. Main U.K. agent Geveke Electronics.

£1,725

DIGITAL EQUIPMENT

DecWriter LA34 KSR

Dot matrix, uses roll or fan-fold paper, friction-feed, up to five copies, V24 or 20mA interfaces, adjustable up to 256 cpl, 30 cps, 7x9 matrix. Main U.K. agent Extel.

£824

A120

7x7 dot matrix, EIA or 20mA option, up to 217 cpl, 180 cps. Main U.K. agent Wilkes Computing.

from £1,645



apple
in **Avon & Bristol**

with full Software Support for business and professional use, including Invoicing, Ledgers, Stock Control, Word Processing, Hotel Systems, Petrol Station Management, Data Base, Dental Records, Mailing Lists and many other applications.

Dataforce (UK) Limited,
68 Alma Road, Clifton,
Bristol BS8 2DJ.
Tel: (0272) 314496

Data force
SYSTEMS SOFTWARE

Write Now for our Software Catalogue

● Circle No. 248

Vets for Pets

Anita Electronic Services (London) Ltd. are specialists in the repair and service of Commodore Pets.

We offer a fast on-site service, or alternatively repairs can be carried-out at our workshops should you wish to bring in your Pet.

Pet maintenance contracts are available at very competitive prices. Trade inquiries welcomed.

For further information tel. or write to: —

JOHN MEADE
ANITA ELECTRONIC SERVICES
15 CLERKENWELL CLOSE, LONDON EC1
01-253 2444

* We also specialise in the repair of all makes of office equipment.

● Circle No. 249

FULLY ASSEMBLED & TESTED FROM **£39.50**
Professional ASCII Keyboards +VAT
Can be used with TANGERINE, TRITON, ACORN etc.

All complete with Metal mounting frames

Coming soon: 12 High resolution Data Display suitable for Apple etc.

MODEL KB 771 B 72 Key £59.50
MODEL KB 756 MF 56 Key £39.50

CARTER KEYBOARDS

Accessories supplied with Keyboard only:
DC to DC Converter DC 512 £5.00
(for operation off single 5v supply)

Model 756 MF Only

Edge Connector	KB 15 P	£1.95
Numeric Key Pad	KB710	£7.50
Plastic Case (Black)	KB705	£12.75

UK Orders add 15% VAT on order total
Overseas Orders add £2.00 p.p.

FULL DATA SHEET ON REQUEST
CITADEL PRODUCTS LIMITED
Department PC, 50 High Street Edgware
Middlesex HA8 7EP Telephone: 01-951 1848

● Circle No. 250



STOKE on TRENT

for
TUSCAN
and
TANGERINE
and
VIDEO GENIE + SOFTWARE
and
BOOKS

MICRO-PRINT Ltd.,
59, Church Street, Stoke on Trent.
(0782) 48348. Barclaycard and Access

● Circle No. 251



JOYSTICK

TAMARISK JOYSTICK

£22.50 inclusive

GAME EXTENSION SOCKET

£6.50 inclusive.

from TAMARISK DESIGN SERVICES
290 Brooklands Rd, Manchester M23
061-969 8729

● Circle No. 252

EXIDY SORCERER

48K

PRICE REDUCED

NOW ONLY £695 + VAT

Dealer for

**Bristol and
South West**

ELECTROPRINT (Mr. Tasker)

5 Kingsdown Parade • Bristol 6 • 292375

● Circle No. 253

MANUFACTURING SOFTWARE

- Bill of Materials
- Stock/WIP Control
- PWS System
(Gross Pay Computation, Piecework, Operations,
Cost Centres)
- Payroll and Accounting
- CPM Compatible

VECTOR GRAPHIC DEALERS
TAYLOR MICRO SYSTEMS LTD.,

HAMSTEAD INDUSTRIAL ESTATE,
OLD WALSALL ROAD, GREAT BARR,
BIRMINGHAM, B42 1DF. 021-358 2436

● Circle No. 254

DIGITRONIX

Mini-Printer

32 column electro-sensitive, 110-4,800 baud, ASCII Serial inputs at RS232C, 20mA, 64 font at 64 cps. Main U.K. agent Digitronix.

£195

ELECTROGRAPHIC AV

EG-800 receive only

Impact, matrix printer, uses any type of paper, parallel, RS232C, TRS-80, Apple interfaces, 80 cpl, 150 cps, 7x5 or 7x6 matrices. Main U.K. agent Electrographic AV Ltd.

from £450

500 series receive only

Impact, matrix printer, uses 3.5in. Tally roll paper and flat documents, serial or parallel interfaces, 40 cpl, 120 cps, 7x5 or 7x6 matrices. Main U.K. agent Electrographic AV Ltd.

from £175 for
mechanism
only

EPSON

TX-80

Impact, dot matrix, friction pin-feed RS232C, V24, 20mA current loop, bit parallel, Centronics, IEEE, Pet, Apple and TRS-80 interfaces, 80 cpl, 150 cps, 7x5 or 7x10 matrices and graphics. Optional PROM chips for high-resolution graphics. Main U.K. agent Data-plus Ltd.

£395

MX-80

Impact, dot matrix, accepts any type of paper, Centronics parallel interface, optional serial and IEEE 488 interfaces, 44, 66, 80, 132 cpl, 80 cps, 9x9 matrix — 2.1 x 3.1mm. High resolution graphics.

£425

EXTEL CORPORATION

M30 receive only keyboard send/receive and automatic send/receive

Impact, dot matrix printer, uses roll or fan-fold paper, V24 or 20mA interfaces, 80 cpl, 30 cps (50 with buffer) 8x7 matrix, 5- or 8-level operation. Main U.K. agent Extel.

£895

M30 B208L keyboard send/receive

Dot matrix, uses roll paper, V24 or 20mA interfaces, 80 cpl, 30 cps, 5x7 matrix, 5- or 8-level operation. Main U.K. agent Extel.

£1,270

FACIT

4520 and 4521

Seven-wire print head, uses roll paper Telex type (Facit 4520), friction feed, fan-fold (Facit 4521) pin feed, serial, V24/RS232C, Centronics parallel interfaces, both fitted as standard, 80 cpl, 100 cps at 12 characters per inch, 9x7 matrix. Main U.K. agent Facit Ltd.

£583

GENERAL ELECTRIC, U.S.A.

ITT 3330

Impact dot matrix, pin feed, V24 interface, 132 cpl, 10, 20 or 30 cps, 7x9 matrix. Main U.K. distributor ITT Business Systems U.K.

£1,496

HEATH ELECTRONICS

WH14

Dot matrix, uses edge-punched fan-fold paper, 20mA, RS232C interfaces, 80, 96, 132 cpl, 132 cps, 5x7 matrix. Main U.K. agent Heath Electronics U.K. Ltd. (OEM sales).

£510



INTEGRAL DATA SYSTEMS

Paper Tiger Model 460

from £700

Dot Matrix, impact printer, pin-feed fan-fold paper, parallel, RS232C, 150 cps, 24x9 matrix. Main U.K. agent Teleprinter Equipment Ltd. and Microsense Computers Ltd.

LEAR SIEGLER INC

300 series

from £965

Dot matrix, uses standard paper, RS232C, 20mA parallel interfaces, Centronics 701/703 type 132 cpl, 180 cps, 9x7 or 9x9 matrices. Main U.K. agent Penny & Giles Data Recorders Ltd.

LOGABAX

LX-213

£1,590

Dot matrix printer, plain paper, fan-fold or cut up to six-ply, RS232C or V24 interfaces, 132 cpl, 218 cpl, 180 cps, 9x7 matrix, optimised bi-directional printing. Main U.K. agent Brospa Data Ltd.

LRC EATON

7000+

£250

Dot matrix printer, uses roll paper, RS232, IEEE, current loop and parallel interfaces, 20, 32, 40 and 64 cpl software selectable by option, 40 cps, 7x7 matrix. Main U.K. agent Russet Instruments.

MALIBU ELECTRONICS CORPORATION

Masterprint 165

£1,400

Dot matrix, fan-fold paper, RS232C, current loop and parallel interfaces, 132 cpl, 165 cps, 10x9 matrix with 18x9 matrix character set which approaches word-processing quality, graphics. Main U.K. agent MBS Terminals Ltd.

MANNESMAN TALLY

Main U.K. agent Data Design Techniques Ltd M-80 MC

from £875

Dot matrix, 9.5in. pin feed paper, all interfaces, 80/132 cpl, 200 cps, 7x9 or 9x9 matrices.

T1612 keyboard send/receive

£1,612

Dot matrix, single or multi-part paper, pin feed, RS232C or 20mA interfaces, 132/218 cpl, 160 cps, 7x9 or 9x9 matrices.

T1612 receive only

£1,475

T1602

£1,395

Dot matrix single- or multi-part paper, pin feed, Data Products, Centronics and serial interfaces, 132 cpl, 160 cps, 7x9 matrix.

MICRO PERIPHERALS INC

MPI-88T

£535

Dot matrix printer, uses fan-fold, roll and cut-sheet paper, RS232C, current loop and parallel interfaces, 80/96/120/132 cpl, all software-selectable, 120 cps, 7x7 matrix. Main U.K. agent Russet Instruments.

NEWBURY LABORATORIES

Model 8300

from £475

Dot matrix, pin-feed paper up to 9.5in., eight-bit parallel interface or CCITT V24, RS232C interfaces, 10 characters per inch, 125 cps, 7x9 matrix. Main U.K. agent Newbear Computing Store.

INSURE YOUR COMPUTER

Impact damage, Fire & Theft Insurance
for your Computer, Equipment:

£1 to £1,500 cover	£8.00 p.a. £10 (excess) x/s
£1,500 to £2,500	£16.00 p.a. £15 x/s.

For details:

KGJ Insurance Brokers,
6 Hagley Road, Stourbridge,
West Midlands, DY8 1QG
Tel (03843) 5333/2545

● Circle No. 255

ACORN ATOM AND TRS-80 JOYSTICK CONTROLLERS

ATOMSTIK — at last a joystick controller for the Acorn Atom I! The Atomstik is based on the famous Atari unit and attaches to the 64 way connector on the rear of your computer. It requires the Versatile Interface Adaptor. It will work with any memory size and requires only Integer Basic. The Atomstik is complete with full user instructions, programming examples and two programs on cassette. Realise the full potential of your Atom for interactive games now!

Prices: Atomstik £26.00 + £1.00 P&P
VIA and connector £12.00 + 50p P&P
(if required)

TANDYSTIK — did you know that the current releases of Big Five machine code games support joystick input? Play Meteor Mission, Galaxian, Super Nova, Cosmic Fighter and Attack Force as you have never before with a Tandystik! The Tandystik is again based on the Atari unit and connects to your TRS-80 via the expansion connector. It is complete with a cassette of two joystick programs, full instructions and examples for user programming. To make your existing software compatible with the Tandystik we can offer Softstik, a machine code utility which allows existing Basic software to accept joystick input without any program modifications — the joystick simulates keyboard responses. Softstik will also operate with machine code programs which use the ROM keyboard routines.

Prices: Tandystik £26.50 + £1.00 P&P
Softstik £9.50 + 50p P&P
(16k on cassette)
Softstik £11.00 + 50p P&P
(32k or 48k on disk)

CSL MICRODATA

4, Greenbarn Way, Blackrod, Lancashire, BL6 5TA.
ACCESS TELEPHONE ORDERS: 0204 694265

● Circle No. 256

PET SOFTWARE SALE!

PETSOFT software cassettes in stock at 50% off normal retail prices.

DISK SOFTWARE

CBM 3000/4000 Series	
COMSTOCK — Stock Control	£ 69.00
COMPLANNER — Business Diary System	£ 99.00
LISP — Complete Package	£ 75.00
COMACCOUNTS — Sales/Purchase/Nominal Ledger Suite	£299.00
COMLEDGER — Sales/Purchase/Nominal Individual Ledgers all	£149.00
PETAID 4.2 — Database 3000/4000 Series	£ 99.00

CBM 8000 Series Modules

ACCOUNTANT Suite:	
Sales/Purchase/Budget Controller Individual Ledgers all	£179.00
Account Link (to integrate above)	£ 49.00
PAYMASTER	£179.00
PETAID 5.1 — Database 8000 Series	£149.00

All prices are ex-VAT

VISA x ACCESS Orders accepted

JOHNSON MICROCOMPUTERS,
75/79 PARK STREET, CAMBERLEY, SURREY.
Telephone: Camberley (0276) 20446

● Circle No. 257



ATARI

Hardware/Software

ATARI 400
£299.50 + VAT

ATARI 800
£564.50 + VAT

ATARI 400 + disk + 32K

Price on application

Space Invaders, Asteroids, Word Processing, Teaching Programs etc. etc.

Ring for list 0454 418596

DORLING MICROSYSTEMS

Tockington, Bristol.

Cash & Carry/Mail Order P & P extra

D.A.I.

48K-355 x 255 Resolution

COLOUR

8080 Processor, FAST BASIC

£595

● Circle No. 258

ATTENTION SHARP PC-1211/TRS-80 POCKET COMPUTER/MEMOWRITER USERS

PFS-123 Paper feed stand with FREE 3" dia. paper Roll £3.95
Pack of 5 rolls 3" dia. for above £3.00

AT LAST BOOKS FOR THE PC1211/TRS-80 POCKET COMPUTERS

50 Programs in BASIC for the Home, School and Office 96 pages £6.95

50 MORE Programs in BASIC for Home, School and Office 96 pages £6.95

101 Pocket Computer Programming Tips and Tricks 112 pages £5.95

Murder in the Mansion and other Computer Adventures 96 pages £4.95

Pocket Computer Programming Made Easy 140 pages £5.95

Pocket Basic Programming worksheets — 40 sheet pad £2.95

CASIO FX702P £117.95

PC-1211 SOFTWARE & HARDWARE AND ACCESSORIES. Send for our new catalogue.

Inclusive prices for U.K. delivery.

24-HOUR LINE 0924 364327.

ELKAN ELECTRONICS

28 Bury New Rd, Prestwich, Manchester, M25 8LD

● Circle No. 259

WESTERN

Western Computers Limited

STOCK MANAGEMENT

with



STOCK — 80 PLUS

- ★ Uses your own part number.
- ★ Fast Record Retrieval using a B-Tree file index structure.
- ★ Runs under CP/M operating system.
- ★ 1500 stock items on Mini Drive System.
- ★ 5500 stock items on 8" Drive System.
- ★ Larger capacities can be catered for.
- ★ Comprehensive Reports.

DEALER ENQUIRIES WELCOME

PLEASE CONTACT US FOR DETAILS

**Blackpool Airport,
Blackpool, Lancs.**

Phone Blackpool 404676 Telex 67162

● Circle No. 261

NIPPON ELECTRIC COMPANY

Spinwriter

£1,500

Combines golf-ball daisywheel and thimble mechanism, uses continuous or single-sheet computer paper, RS232C serial (RO and KSR), Centronics-compatible and Diablo-compatible interfaces, 8080 input bus line, current loop, 55 cps, solid-font matrix. Main U.K. agent Memec Systems Ltd.

OKI

Microline 80A

£299

Dot matrix, 9x7, 80 cps, 80 or 132 cpl, pin, traction or friction feed, RS232, 20mA Centronics. Main U.K. agent X-Data.

Microline 82A

£399

Dot matrix, impact printer, 80 cps, bi-directional logic-seeking, 40, 66, 80 or 132 cpl, pin, friction or tractor feed, serial and parallel interface, 160 characters. Main U.K. agent X-Data.

QUME

Sprint 5/45 receive only

£1,795

Daisywheel mechanism, uses plain paper, fan-fold or cut appear A4 up to six-ply, RS232C or V24 interfaces, 156 cpl at 12 pitch, 45 cps. Main U.K. agents, Access Data Communications and ISG Data Sales.

RAIR

Main U.K. agent Rair Ltd

820/825 Desk-top printer

£1,090

Dot matrix, RS232C interface, 132 cpl, 75 or 150 cps, 7x7 matrix.

DecWriter IV keyboard printer, KSR and read only

£795

Dot matrix, uses standard listing paper, RS232C current loop interface, 215 cpl, 30 or 180 cps, 9x7 matrix.

M200

£1,995

Dot matrix, uses continuous paper, parallel or serial interface, 132 cpl, 340 cps, double 7x9 matrix.

DecWriter III

£1,550

Dot matrix, uses continuous listing paper, RS232C or 20mA, current loop interfaces, 132-215 cpl, 180 cps, 7x7 matrix.

RICOH

RP-1600

£1,295

Daisywheel, uses single-sheet or continuous paper, Centronics and compatible interfaces, 132 cpl, 60 cps. Main U.K. agent Nexos (U.K.) Ltd.

ROXBURGH PRINTERS

X80 SP printer/plotter

from £896

Dot matrix, impact printer/plotter, pin-feed, fan-fold paper, RS232C, IEEE488, CBM, Centronics, HP85, 20mA, Tektronix, 80/96 cpl, 100 cps bi-directional, 8x8 matrix, three character generators, various other generators. U.K. dealer Roxburgh Printers Ltd.

RP 8031

from £163

Dot matrix, impact printer, Tally roll, parallel, RS232C, 20mA, 21 cpl, 150 lpm, 5x7 matrix, sprocket-feed option for labels. U.K. dealer Roxburgh Printers Ltd.

RP 8040

from £182

Dot matrix, impact printer, Tally roll, parallel, RS232C, 20mA, 40 cpl, 72 lpm, 5x7 matrix, sprocket-feed option for labels. U.K. dealer Roxburgh Printers Ltd.



S FARID (SPECTRONICS) MANUFACTURING

TP-40 and TP-65 receive only

from £660

Thermal, matrix, uses thermal paper, cost of paper £1.80 each roll, seven-bit parallel interface, push-button control and self-test, 40 or 64 cpl, 13 or 18 cps, 7x5 dot matrix. Main U.K. agent S Farid (Spectronics) Manufacturing Ltd.

TALLY

Main U.K. agent Data Design Techniques Ltd

T1612 keyboard send/receive

£1,612

Dot matrix, pin-feed, single- or multi-part paper, RS232C or 20mA interfaces, 132-218 cpl, 160 cps, 7x9 or 9x9 matrices.

T1612 receive only

£1,475

T1602

Dot matrix, pin-feed, single- or multi-part paper, Data Products, Centronics and serial interfaces, 132 cpl, 160 cps, 7x9 matrix.

TELETYPE CORPORATION

Model 43 keyboard send/receive

£800

Impact matrix printer, uses pin-feed or friction-feed, dual RS232C and 20mA current loop interfaces, 132 cpl, 30 cps, 4x7 matrix on nine-wire printhead. Main U.K. agent Geveke Electronics Ltd.

TEXAS INSTRUMENTS

Main U.K. agents Texas Instruments and Rair Ltd

OMNI 800 series

from £1,090
to £1,650

Models 810, 820 and 825

Dot matrix printers, uses paper, EIA, current loop, parallel interfaces, 132-216 cpl compressed print (models 820 and 825), 132 cpl (model 810), 75 cps (model 825), 150 cps (models 810 and 820), 9x7 matrix.

Silent 700, model and 745 portable

£1,250

Thermal mechanism, uses thermal paper at £1.50 per 100ft. roll, integral acoustic coupler, EIA interfaces, 80 cpl, 30 cps, 5x7 matrix.

Silent 700, 743 Keyboard send/receive version

£1,105

Thermal mechanism, uses thermal paper at £1.50 per 100ft. roll, EIA, 20mA current loop interfaces, 80 cpl, 30 cps, 5x7 matrix.

TRANSDATA

313 Receive only

£790

Dot matrix mechanism, uses thermal paper at £60 per box of 24 rolls x 150ft. RS232C and parallel interfaces, designed for use as VDU hard copy, 80/132 cpl, 30 to 45 cps, 7x5 matrix. Main U.K. agent Transdata Ltd.

TRANSTEL COMMUNICATIONS

AR receive only

P.O.A.

Dot matrix, uses standard teleprinter paper, V24, current loop interface, 80 cpl, 30 cps, 7x5 matrix. Main U.K. agent Transtel Communications Ltd.

SHOP WINDOW

SCROLL UP SCROLL UP
There's Money to be made
If you can write good PET
Games & Educational
Programs

ALPHA PLUS needs YOU

Contact **Mike Nott**
AVON COMPUTER RENTALS
FREESTOP Thornbury
BRISTOL PC BS12 1BR

● Circle No. 262

MICRO ADS

are accepted from private readers only, pre-paid and in writing, 20p per word, minimum charge £2.

Please make cheques payable to Practical Computing and send to Room L311, Quadrant House, The Quadrant, Sutton, Surrey SM2 5AS.

PET 8K, large keyboard and cassette, together with Seikosha GP80A printer, almost new. £705 ono. Tel: 01-567 3547.

UK101/SUPERBOARD Programmer's Tool-kit. 2K of fast machine code on tape giving 14 new commands including Renumber, Delete, Search, Trade and Old. You'll wonder how you ever managed without it! Compatible with all monitors. Only £10 inclusive with full instructions (state your computer's memory size). S. A. Smith, 36 Woodvale Avenue, London SE25 4AE.

SHARP PRINTER MZ-80 P3 & I/O unit. Both brand new & unused. With service manuals & paper. Offers please telephone Stevenage (0438) 596777 anytime.

FOR SALE: Pericom 6801 VDU. BASF 6104 drives for sale. Used. Please telephone D. F. Green on 01-568 6281 for further information.

PET 2001 New ROMS 32K. Cassette. Sound-box. Games Software (£150 worth) £675 ono. Willing to help with your programming. Deliver within 200 miles. Plymouth (0752) 260781.

WASP SYNTH £150 ono. Spider Sequencer £150 ono. Retford (0777) 707947.

RADIOFIN Programmable game with ten cartridges including Space Invaders and Programmable chip compatible with Acetronic and Princetronic Cartridges. Cost new £270. Ring 0686 88502.

TRS-80 48K. Disk drive, printer, software. £500. Tel: 061-707 3978.

SIX 2K ATOM games: £5.50. P. Robinson, 26 Grove Walk, Norwich NR1 2QG.

ZX81 STAR WARS, 16K, full realtime moving graphics, on screen scoring, fire the Photon Gun and explode the Empire Ship, written in Basic. £3.00 for cassette and instructions. K. J. Gouldstone, 79 Bridge Road, Chessington, Surrey.

PET GAMES. Well tried by critical acquaintances. Cheap. SAE Earl Dandy, 29 Marina Ave., Redcar, Cleveland.



DISK NASCOM 64K/4MHz — with twin drive CP/M Gemini disks and software and Anadex DP8000 printer, 2 parallel/2 serial ports, expanded keyboard, graphics and monitor, cassette interface, to 2400 baud. All as new. Offers. Stroud, Castleton (N. Yorks) 281.

PET 2001-8 for sale, well used, very reliable, £250 includes instruction books. Tel: Luton 423885 daytime.

ZX80 & ZX81. Join ZX guaranteed. All Games/Programs guaranteed to work. £5/year. Frustrated National ZX80 Club people are welcome. Bobker, 29 Chadderton Drive, Unsworth, Bury, Lancs.

APPLE II PLUS 48K, 2 disk drives, 12 inch monitor and 10 blank cassettes. 2 months old. £1,650. Tel: 0225 837868.

PET 4040 DISK DRIVE £590, 4032 computer £590, 4022 printer £310. All items as new — hardly used. Tel: Whitworth 2592.

ACORN ATOM SYNTHESIZER 7K. This superb musical instrument includes seven octaves, random music, user defined notes, sequences; plus full edit, load, save, and tempo change facilities. Incredible entertainment for only £8. D. W. Moran, 99-101 St Leonards Road, Windsor, Berks.

ICs FOR SALE. A limited number to clear as surplus to contract requirements. Mostek Z80 CPU 2MH £2 each. 4116N & 8116M £1.95 each, plus post and packing. Over 50 P&P free. Tel: 0635 32442. Ref. CT/MH.

8K PET FOR SALE. Good working order, £250. Tel: Luton 423885.

GIVEAWAY — SORCERER 32K, 630K double disc unit, prof monitor, S100 bus with 5 slots and disc controller fans fitted. Extensive software included in price. Worth £3,800 without software, offers £1,600. Details by phone: 0222 568286 or 0222 27336.

ZX81 (16K RAM) SOFTWARE. Fed up with nothing but games? Why not try one of our educational cassettes.

JUNIOR MATHS 1:— 6 programs on one cassette; "LONG MULTIPLICATION", "LONG DIVISION", "HCF", "LCM", "FRACTIONS 1" (+ and -) and "FRACTIONS 2" (X and :). All programs teach and then test. Explanations are given. Comment from a teacher: "I find the standard to be quite exceptional." Order no. JMTH 1. Price £4.50.

ROSE CASSETTES, 148 Widney Lane, Solihull, West Midlands B91 3LH.

5 GAMES PROGRAMS, TRS-80, L.1.4K, on tape. Space Simulation, Tank Command, Maze, Connect 4, One-arm Bandit. Send £5 to B. Jackett, 48 Fairwater Avenue, Welling, Kent.

PET 2001/32K, large keyboard, cassette, tool kit, manuals, cover, £650 complete. Phone: Rossendale 26313 evenings.

APPLE SYSTEM for sale, complete, 2 discs, printer, may split, few months old, still under guarantee. Phone for details: 01-450 5049 evenings and weekends.

HIGH QUALITY Computer Grade Tape Cassettes (C60), certified error free, £1.25 inc p & p, each in library box, 4 or more £1 each inc p & p. S. L. J. Gilinsky, 15 Thornhill Park, Sunderland SR2 7LA.

8K PET FOR SALE. Good working order, £250. Tel: Luton 423885.

UNITED SYSTEMS CORPORATION

Main U.K. agent Aviquipo Ltd

DigiTec 6320 £483

Electro-sensitive dot matrix, electro-sensitive line roll paper at £1.80 per roll, RS232C or isolated 20mA current loop, 21 or 32 cpl, prints two lines per second, 1,200 Baud receive, 5x7 matrix.

DigiTec 6330 £421

Dot matrix, electro-sensitive paper at £1.80 per roll, 8-bit parallel/character serial, 21 or 32 cpl, 5x7 matrix.

DigiTec 6410 £237

Dot matrix, electro-sensitive paper at £1.80 per roll, RS232C or 20mA current loop, 21 or 32 cpl, two lines per second, 5x7 matrix.

DigiTec 6420 £237

Dot matrix, electro-sensitive paper at £1.80 per roll, 8-bit parallel serial, 21 or 32 cpl, prints two lines per second, 1,200 Baud receive, 5x7 matrix.

DigiTec 6450 £266

Dot matrix, thermal paper at £1.80 per roll, RS232C 20mA current loop, 21 cpl, prints two lines per second, 110 or 300 Baud receive, 5x7 matrix.

DigiTec 6460 £266

Dot matrix, thermal paper at £1.80 per roll, eight-bit parallel serial 21 cpl, two lines per second, up to 1,000 Baud receive, 5x7 matrix.

DigiTec 6550 £289

Dot matrix, thermal paper at £1.80 per roll, RS232C or 20mA current loop, 21 or 32 cpl, prints two lines per second, 110 or 300 Baud receive, 5x7 matrix.

VECTOR GRAPHIC

MP printer £599

Uni-directional seven-wire x five-column dot matrix, original and one copy, maximum paper thickness 0.2mm., uses pin-wheel paper feed, 70 lines per minute, 150 cps, TTL level interface, two parallel output ports and one-parallel input port. Main U.K. agent Almarc Data Systems Ltd.

WALTERS MICROSYSTEMS

Dolphin BD-80P £525

Impact, dot matrix, adjustable sprocket feed, any one of three interface choices, 10 characters per inch, 80 cpl, full ASCII character set, self-testing, 64 graphics characters, 9x7 and 11x7 matrices, double-width characters, bi-directional printing. Main U.K. dealers Texas Instruments or Walters Microsystems.

Dolphin BD-136 £560

Impact, dot matrix, forms tractor, fully interfaceable, 136-226 column width, full graphics capability, 7x9, 9x9 matrices, 32 user-definable characters plus full ASCII set, data-formatting functions, fully logic seeking, self-testing. U.K. dealers Nexos.

WENGER DATENTECHNIK

Sole U.K. distributor Access Data Communications Ltd

Print Swiss Matrix Printer from £700

Dot matrix RS232C, 20mA, 60mA and parallel interfaces, Centronics-compatible, 80 cpl, constant throughout 80 cps, 55-1000 lines per minute, 7x7 matrix. KSR version also available.

Penny & Giles hard copies from £365

Electro-static RMP paper 127mm. x 70m. at £3.50 per roll, RS232C, current loop option, 80/40/20 cpl, 80 columns, 110 lines per minute, 8x5 line printer, 5x7 message printer matrix.



WHYMARK INSTRUMENTS

Main U.K. agent Whymark Instruments Ltd

Model 201 £440

Dot matrix, Tally-roll paper printer, IEEE, RS232C, serial, and parallel interfaces, 40 cpl, 40 cps, 52 character set with four-character sizes.

Model 204 label printer £515

Dot matrix, impact printer for self-adhesive labels, IEEE, RS232C, serial and parallel interfaces, 40 cpl, 40 cps, 52 character set with four-character sizes.

Model 3011 ticket/form printer £690

Dot matrix, plain paper, options automatic date and time, IEEE, RS232C, 40 cpl, 40 cps, 52 character set with four character sizes.

Model 501 rack-mounting printer £625

Dot matrix plain paper, options automatic date and time, IEEE, RS232C, 40 cps, 40 cpl, 52 character set with four character sizes.

Model 801 80/120 column printer £750

Dot matrix, plain or fan-fold paper, proportional spacing up to 120 cpl, 120 cps, bi-directional printing, user-definable character set, up to 4K selectable character fonts, graphics, and user-definable characters, also available; very large characters seven lines high.

Alphabetical list of suppliers

Supplier	Address
Access Data Communications Ltd, 0895-30831	228 High Street, Uxbridge, Middlesex UB8 1LD.
Almarc Data Systems Ltd, 0602-625035	906 Woodborough Road, Nottingham NG3 5QS
Anadex Ltd, 025672-3401	Weaver House, Station Road, Hook, Hampshire RG27 9HU
Aviquipo of Britain Ltd, 0628-34555	St. Peter's Road, Maidenhead, Berkshire SL6 7QU
Cable and Wireless 01-928 0261	83 Blackfriars Road, London SE1 8HQ
Cifer Systems Ltd, 0225-704502	Avro Way, Bowerhill, Melksham, Wiltshire SN12 6TP
Clary Ltd, 01-680 2222	12-14 Lower Addiscombe Road, Croydon, Surrey CR9 6AG
Comma Computers, 0277-811 131	West Horndon Ind Park, West Horndon, Essex CM13 3MJ
Dacoll Engineering Services Ltd, 0438-438 1/0506-56565	Gardners Lane, Bathgate, West Lothian
Datac Ltd, 061-941 236/2	Tudor Road, Broadheath, Altrincham WA14 5TN
Data Design Techniques Ltd, 01-207 1717	12 Leeming Road, Borehamwood, Hertfordshire WD6 4DU
Data Dynamics, 01-848 9781	Data House, Springfield Road, Hayes, Middlesex
Data General Ltd, 01-572 7455	3rd and 4th Floors, Hounslow House, 724-734 London Road, Hounslow, Middlesex TW3 1PD
Dataplus Ltd, 0242-30030/37373	39-49 Roman Road, Cheltenham GL51 8QQ
Datatrade Ltd, 0604-22289	17 Billing Road, Northampton NN1 5AW
Davinci Computers Ltd, 01-952 0526	65 High Street, Edgware
Diablo Systems Ltd, 04862-71991	Regent House, 20 The Broadway, Woking, Surrey GU21 5AP
Digitronix Ltd, 0908-566888	10 Burners Lane, Kiln Farm Industrial Estate, Milton Keynes
Electrographic AV Ltd, 01-573 1826	Printinghouse Lane, Hayes, Middlesex UB3 1AP

ZX 81 (16K RAM) SOFTWARE. Fed up with nothing but games? Why not try one of our educational cassettes.

JUNIOR MATHS 1:—6 programs on one cassette; "LONG MULTIPLICATION", "LONG DIVISION", "HCF", "LCM", "FRACTIONS 1" (+ and -) and "FRACTIONS 2" (X and ÷). All programs teach and then test. Explanations are given. Comment from a teacher: "I find the standard to be quite exceptional." Order no. JMTH 1. Price £4.50.

ROSE CASSETTES, 148 Widney Lane, Solihull, West Midlands B91 3LH.

ACORN ATOM. Full rom. Full ram extended PSU, £175. Phone: (0332) 841235.

SHARP MZ80K 48K, P3 printer, interface unit, assembler tapes, word processor, many games (some m/c), basic enhancements, listings, manuals, £900. Tel: Reading 584497.

FOURIER ANALYSIS for the 1K ZX81. Easily re-written for other machines. FFT (16k) also available. £2.50 each and SAE for description and listing. R. Taylor, 6 Grant Road, Farlington, Hants, PO6 1DX.

GAMES FOR CBM 8032. Hangman — a fascinating word game with pictures. Hed-banger — an infuriating game with numbers. Send cheques/POs to Liftmark Ltd, 17 Wreford Close, St Columb Major, Cornwall TR9 6SE.

PET 8K 2001, cover, books, programs, £225. 01-674 8588 eves/WE.

UK101 PROGRAM. 3D Dungeons of Rahm (4K/8K). Superb graphics, £3, cassette. SAE for further details: P. Watts, 54 Thorpe Lea Road, Peterborough.

TRS-80, 16K, Level 2 cpu, cassette recorder and various software, £280. Phone: Walsall 28867.

NASCOM SOFTWARE. Standard Z-80 assemblers with NAS resets, 5.7K cassette £12, 8.5K D DOS £18; Word processors, 3K, cassette & 4K D DOS £18; 2K position independent debus £9; 2K relocatable disassembler £11; D DOS card index catalogue simulator £15; Hybrid BASIC (not sold separately) D DOS or cassette £4. Details: SAE Mr P. Watson, 101 Village Road, Bromham, Bedford MK43 8HU.

16K TRS-80, green, VDU, cassette, programmable sound generator, 30 tapes mostly Arcade games, editor assembler, £450. Tel: 01-703 9265.

16K PET, large keyboard plus separate cassette, 8 months old, little used, excellent condition, £500. Tel: Romford 20791 after 7pm.

PET 8K, Old Rom, small keyboard, Microchess, games and maths programs, Pet revealed, deliver locally (Warrington), £290. Tel: (0925) 722430.

NASCOM SOFTWARE. Standard Z-80 assemblers with NAS resets 5.7K cassette £12, 8.5K D DOS £18, Word processors 3K cassette & 4K D DOS £18, 2K position independent debus £9, 2K relocatable disassembler £11, D DOS card index catalogue simulator £15, Hybrid BASIC (not sold separately) D DOS or cassette £4. Details: SAE Mr P. Watson, 101 Village Road, Bromham, Bedford MK43 8HU.

STAR CHESS, unwanted gift, guaranteed, with mains adaptor, £40. Aldridge (0922) 53574.

ACORN ATOM (EXPANDED), plus book and programmes (including "Space Invaders"). Worth £370, only £250. Tel: 01-542 0705.

PRINTER, EPSON MX80 F/T. Parallel and serial interface. As new, £400. M. Fisher, 44a High Street, West End, Southampton, Hants. Phone: 04218-4948.

ZX81 MATRIX PLANNER. Ever wished VisiCalc ran on the ZX81? MATRIX PLANNER gives on-screen modelling using VisiCalc concepts. Complex forecasting, financial planning, 'what-if' analysis. Needs 16K. £5 from Graham Asher, 60 Maryland Road, Wood Green, London N22 5AN. (Cassette, instructions).

SUPERBRAIN 64K QUAD. Over £1,000 worth of software. Diablo 1500 with tractor feed and stand (needs attention). Private sale, no VAT, bargain at £1,995. Phone: 01-989 0430.

FOR SALE ZX80 — 16K, new rom & books, software, cassettes, space invaders. Good condition. £100 ono. Phone: (0661) 32370, after 6pm.

MICRO WANTED. 48K or 64K, complete with disks etc. CASH WAITING. 01-501 1122, 01-888 8216. Mr Bernard.

TRS-80 SOFTWARE, for 16K LII 3-D MAZE, you choose the size — excellent graphics, FRUIT MACHINE III — hold, nudge and gamble features. BACKGAMMON — double cube, many levels of play, £5 each (on tape) including instructions. All three £12. Send to C.P.H. Software, 15 Wallis Road, Waterlooville, Hants PO7 7RX.

TRS-80 16KL2 — Upgrade to disks forces sale of £600 of tape based software, games, business, utilities, educational. Bargain prices. Tel: 061-445 7191.

TRS-80 LEVEL II 16K, manuals, tapes, magazines. £250. Phone: Sheffield (0742) 308518.

ATOM SOFTWARE 3 Dimensional Noughts & Crosses, French Vocab, Life, Hamurabi, Bio-rhythms f.p. and Uni-File — ideal for address list, membership records, inventory etc. Any two programs on cassette. £4.95. G. Byrns, 7 Grannis Dr, Aspley, Nottingham.

PET-8K, £300 ono. Drayton (near Oxford) 0235 89-269 (evenings and weekends).

APPLE II: 64K of memory, full documentation, Pascal board giving full Pascal system, VHF adaptor, 2 disc drives, serial/parallel interface board and supporting software. Enquiries to A. Hunsdon, 6 The Frances, Thatcham, Berks, RG13 4ET for offers of £1,700 ono.

TEXAS INSTRUMENTS 743 KSR Terminal Thermal Printer with Acoustic Coupler, £395. Blackburn (0254) 49704.

COMMODORE PET MODEL 3032 with disc drive 3040 and printer 3022, used only approximately 25 hours from new. £1,650. Telephone: Brill (0844) 237666.

ACORN SYSTEM 1, complete with extra 1/0 chip, £60 ono. Tel: 0487 812812.

64K TRS80, VDU, keyboard with numerical keypad, expansion interface, 40 track disc drive, teletype printer, TVJ232 serial interface, cassette, modern office desk and chair, new DOS + DOS, basic word processor, many programs and books, £925. Hastings (0424) 440098.

Extel,
01-739 2041

Facit Ltd,
0634-40172/7

Fortronic Ltd,
0383-823121

Geveke Electronics Ltd,
04862-71337

Heath Electronics (U.K.) Ltd,
0452-29451

ISG Data Sales Ltd,

95-57955

ITT Electronic Services,
0279-26777

ITT Business Systems,
0273-507111

Kode Services,
0249-813771

Maclin-Zand Electronics Ltd,
01-837 1165/01-278 7369

MBS Terminals Ltd,
09323-53151

Memec Systems Ltd,
084421-3149

MIBF
0734-415191

Microbyte,
01-278 7369

Microsense Computers Ltd,
0442-48151/41191

Newbear Computing Store,
0635-30505

Nexos U.K. Ltd,
084421-3151

Penny & Giles Data
Recorders Ltd,

042-5271 511

Peripheral Hardware Ltd,
01-941 4806

Rair Ltd,
01-836 4663

Robox Office Equipment Ltd,
041-776 4388

Roxburgh Printers Ltd,
07973-3777

Russet Instruments Ltd,
0734-868147

S. Farid (Spectronics)
Manufacturing Ltd,

02013-77337

SEN Electronics
09328-66744

Sintrom Electronics
0734-85464

Stack Computer Services Ltd,
051-933 5511

Teleprinter Equipment Ltd,
044282-4011/9

Terminal Display Systems Ltd,
0254-662244

Texas Instruments Ltd,
0234-67466

Transdata Ltd,
0705-486556

Wilkes Computing Ltd,
0272-25921

Whymark Instruments Ltd,
07372-21753

X-Data
0753 49117

Engineering Division, The Exchange Telegraph
Company Ltd, 73-75 Scrutton Street, London
EC2 4TA
Maidstone Road, Rochester, Kent

Donibristle Industrial Estate, Dunfermline

RMC House, Vale Farm Road, Woking, Surrey

Bristol Road, Gloucester GL2 6EE

Unit 9, Fairacre Industrial Estate, Dedworth
Road,

Windsor, Berkshire

Edinburgh Way, Harlow, Essex

Crowhurst Road, Hollingbury, Brighton
BN1 8AN

Station Road, Calne, Wiltshire SN11 0JR

38 Mount Pleasant, London WC1X 0AP

Aldwych House, Madeira Road, West Byfleet,
Surrey KT14 6BA

Park Industrial Estate, Thame, Oxon

Barclays Bank Chambers, Pegg Lane, Kirkgate,
Tadcaster, North Yorkshire

Unit 9-10, 1st Floor, 38 Mount Pleasant, London
WC1X 0AD

Finway Road, Hemel Hempstead, Hertfordshire
HP2 7PS

49 Bartholomew Street, Newbury, Berkshire

3 Jefferson Way, Thame, Oxfordshire OX9 3FU

Mudford, Christchurch, Dorset BH23 4AT

Armfield Close, West Molesey, Surrey

30-32 Neal Street, London WC2H 9PS

84 Townhead, Kirk in Tiloch, Glasgow, Scotland

22 Winchelsea Road, Rye, E. Sussex
TN31 7BR

Unit 1, Nimrod Way, Nimrod Industrial Estate,
Reading, Berkshire RG2 0EB

Dawkins Road, Industrial Estate, Poole, Dorset
BH15 4JY

5 London Street, Chertsey, Surrey

14 Arkwright Road, Reading, Berkshire RG2 0LS

290-298 Derby Road, Bootle, Liverpool L20 8LN

Akeman Street, Tring, Hertfordshire HP23 6AJ

Hillside, Whitbriik Estate, Blackburn, Lancashire
BB1 5SN

Manton Lane, Bedford MK41 7PA

11 South Street, Havant, Hampshire

Bush House, 72 Prince Street, Bristol BS1 4HU

6 Holmsdale Road, Reigate, Surrey RH2 0BQ

Marish Wharf, St Mary's Road, Langley, Slough,
Berkshire SL4 1HE



April 23-25, 1982
Earls Court,
London

**Bringing
computers
to life**

THE Computer Fair

**Personal computers
Home computing
Small business systems**

In all walks of life, personal computers have revolutionised computer power — bringing it within the reach of a far wider and more popular market than ever before.

In 1982 this revolution will explode onto the home and personal computer market. To meet this demand, Practical Computing and Your Computer announce a brand new event — The Computer Fair. The promotion of the exhibition will be heavily geared to attract the growing market of potential and existing users of personal computers, from home computer enthusiasts to businessmen.

Bring your computers and services to life — all walks of life — at The Computer Fair!

Complete and return the coupon — we'll send you details.

THE
**Computer
Fair**
Personal computers
Home computing
Small business systems

Exhibition Manager,
THE COMPUTER FAIR,
IPC Exhibitions Ltd.,
1, Throwley Way,
Sutton, Surrey, SM1 4QQ



Name _____
Position in Company _____
Company _____
Address _____

Tel. No. _____

● Circle No. 260

the software house

SUPER PROGRAMS

PLEASE ADD VAT AT 15% TO ORDERS AND 80p POSTAGE (EXCEPT MAGAZINES £1.20 POSTAGE). OUR SHOP IS AT 1 HORSESHOE YARD, OFF BROOK STREET, LONDON W1. OUR TELEPHONES ARE 01 493 3420 / 0566.

TRS-80 PROGRAMS

ADVENTURE 11 SAVAGE ISLAND 2	11.97
ADVENTURE 12 GOLDEN VOYAGE	11.97
ARCADE 80	11.00
ATLANTEAN ODYSSEY	9.00
ATTACK FORCE	9.00
BATTLE TREK	18.00
BATTLE OF SHILOH	15.00
BALLOON RACE	9.00
BANK ROBBERY	9.00
COSMIC FIGHTER	9.00
CRUSH, CRUMBLE & CHOMP (D)	15.00
CURSE OF CROWLEY MANOR	8.00
DAMBUSTERS	9.00
DARKSTAR	12.00
EMPIRE OF THE OVERMIND (C)	18.00
EMPIRE OF THE OVERMIND (D)	21.00
GALAXY INVASION	9.00
GALACTIC BLOCKADE RUNNER	9.00
IAGO	12.00
KEYS OF ACHERON	12.00
LOST SHIP ADVENTURE	9.00
INTERACTIVE FICTION (D)	10.00
SPACE ROCKS	12.00
LABYRINTH	9.00
DEATHMAZE	9.00
ASYLUM	9.00
STARFIGHTER	15.00
TANKTICS	15.00
TREASURE QUEST	9.00
MISSILE ATTACK	9.00
STARFLEET ORION	13.60
MYSTERY FUN HOUSE)	
PYRAMID OF DOOM)	11.00
METER MISSION 2	9.00
UPPER REACHES OF APSHAI (C & D)	12.00
SCARFMAN	9.00
TALKING ROBOT ATTACK	9.00
TIGERS IN THE SNOW	15.00
VAULTS OF CYMARRON (C & D)	20.00
WIZARDS MOUNTAIN ADVENTURE	9.00

TI 99/4 PROGRAMS — SEND FOR OUR LIST OF TI 99/4 SOFTWARE.

* SPECIAL ** APPLE JUICE £135

CCA DATABASE FOR APPLE & TRS-80 £ 45

EXPEDITER £60

SAMPLE ISSUE KILOBAUD MICROCOMPUTING £1

STAR VENTURE

The Ultimate "Star Trek" game entirely in Graphics. Fantastic Star Bases, Alien Landscapes, Transporter Room, the Bridge, Enemy Battle Cruisers. All here in Incredible Detailed Graphics and Sound. By MERLIN.
For APPLE 11 Plus with 48K & Disk.

VAULTS OF CYMARRON

Pursued around the Ruins of a Hostile Moon by a variety of monsters, you must regain lost Treasures for the Gangsters of the Pleasure Planet.
A Real-Time Graphic Adventure with Sound. By the author of Darkstar.
For TRS & Video Genie, 16K Tape or 32K Disk.

APPLE PROGRAMS

ADVENTURE IN TIME	17.97
BOTH BARRELS	11.97
OO-TOPOS	20.00
BATTLE TREK	24.00
BATTLE OF SHILOH	24.00
BATTLESHIP COMMANDER	12.00
BEER RUN	20.00
CASTLE OF WOLFENSTEIN	17.97
CROWN OF ARTHIAN	21.00
CRANSTON MANOR Hires Ad	21.00
CYBORG	20.00
COPTS & ROBBERS	20.00
EPOCH	20.00
EXPEDITER COMPILER	55.00
GOLDEN MOUNTAIN	11.97
GALACTIC ATTACK	17.97
FALCONS	17.97
INFERNO	17.97
MADVENTURE	15.00
OUTPOST	17.97
PHANTOMS FIVE	14.97
PULSOR	17.92
ORBITRON	17.97
PALACE IN THUNDERLAND	15.00
ROBOT WAR	24.00
SPACE QUARKS	17.97
STAR VENTURE	20.00
STAR CRUISER	14.92
TIGERS IN THE SNOW	24.00
TIMEZONE — Hires Adv 2 Disk	55.00
ULYSSES & THE GOLDEN FLEECE	21.00
WARP DESTROYER	17.97
WIZARDRY	28.00

ATARI PROGRAMS

LUNAR LANDER	9.00
GALACTIC ADVENTURE	12.00
STARTREK 3.5	12.00
STAR WARRIOR	23.00
RESCUE AT RIGEL	17.97
MICROCHESS	13.00
6502 DISASSEMBLER	8.00
INVASION ORION	15.00
NAME THAT TUNE	9.00
3D SUPERGRAPHICS	23.00
STARBASE HYPERION	12.00

We have an ENORMOUS range of BOOKS & MAGAZINES (a whole year's issues of 80 Micro)

APPLE MACHINE LANG PROGRAMMING £9.80

Son of Hexadecimal kid

Having been converted to the worship of Megabrain, Samson returns to Earth. He attempts to win over the population by giving away free micros in the Nullard capital, where even to breathe the word "computer" is to risk imprisonment by Bottleneck's minions.

The two spies rushed along the cloistered corridors behind the chapel of St Igor and burst into Bottleneck's sumptuously-appointed private chamber.

"What's this"? He looked up angrily.

"Forgive us, Brother Superior, but this is urgent. A man calling himself Son of Hex has set up his stall in the central square and is distributing micro-computers to the people".

"Selling micros? Arrest him for trafficking".

"He's not selling them. He's giving them away".

"Giving them away"! Bottleneck was aghast.

"What's more, he's starting to teach them assembly language", added one of the informers. "They're sitting at his feet like lambs, hanging on his every word".

"Then we'll get him for illegal assembly".

"But that's not a capital offence".

"Good thinking. We have to put a stop to all this for good. Get him for blasphemy, heresy . . . anything. Just haul him in. We'll prepare the charges later".

Samson's brief moment of glory lasted one day. In the afternoon he was borne aloft through the city streets by cheering thousands, their computer-starved brains high on Space Invaders and VisiCalc. Cries of Hail to the Son Of Hex! filled the air. By nightfall he was under arrest, being hustled away in a black van while police dispersed the demonstrators with tear gas.

The ecclesiastical courtroom, where Samson appeared next morning, was bare and cold. The chief interrogator swirled into the room, trailing his lavish vestments behind him. It was Bottleneck himself.

"I trust you realise the gravity of the charges you have been brought here to answer", he began.

"What charges"?

"Never mind what charges", snapped the interrogator impatiently. "Just remember they're serious".

"Yes Sir".

"Now, to begin with, who or what is Megabrain"? He pronounced the last word with exaggerated contempt.

"Megabrain is the inherent law of the universe, the ideal we strive towards. Megabrain is the universe operating as a computing system, so computers are a step on the road to Megabrain's actualisation. When the cosmos is a unified system, Megabrain will be realised".

Bottleneck looked over to where the court recorder sat, pencil scratching

furiously on his pad. "Have you got all that down"? he enquired.

The stenographer nodded.

"I cannot define Megabrain for you," Samson continued, "but I can help you recognise Megabrain's nature in yourself".

"Yes, yes," interrupted Bottleneck. "That's quite enough. Let's hear about you: you claim to be the Son of Hex".

"I am the Son of Hex".

"You mean mean to tell us that Samuel Synapse, destroyer of the accursed System, was your father"?

"He was. Though the system he destroyed is not the one that I come to build".

"But you're too young".

"I have travelled in space, beyond the edge of our galaxy; that is why I have not aged".

Bottleneck permitted himself a smile. It was proving easier than he had expected. The suspect was condemning himself from his own mouth.

"It would appear that you are a systematist at heart".

"We are all systematists at heart. Even you. One day you will realise it".

"The prosecution rests its case", Bottleneck told the court.

The tribunal of lay magistrates, two men and a woman, rustled their papers. One of the men took a swig of water. The woman leaned over the bench.

"Has the prisoner anything to say in his defence"? she enquired.

"Only that I come to set you all free", responded Samson. "The world is in darkness. To erase data is to suppress truth; to halt computing is to shackle the mind. I will open your eyes to the light".

The verdict, guilty, was reached within minutes. Samson listened as the sentence was read out to him. Gradually the chilling realisation sank in that death was very close. He was to be stoned that very day.

Ada had worried after Samson had left, and had followed him into town the next day. There she heard the news of his brief fame and subsequent arrest. When the time and place of his execution were announced she joined the throng of people trekking out from around the country to the appointed spot.

The crowd was muted. As Samson arrived, escorted by a platoon of heavily-armed guards, there were a few hostile shouts, but most people remained silent. Some of his erstwhile supporters were there, staying quiet for fear of reprisals.

Samson was led down into the gully by the captain of guards. He read out the

deposition which included most of the "confession" Samson had given the court. Having made sure that Samson was firmly bound hand and foot, he marched smartly up the slope.

Reaching the top, he turned round, picked up a small pebble, and hurled it at the condemned man. It was a symbolic gesture, to relieve from the other stone-throwers the guilt for casting the first stone. As it happened the officer had an excellent aim and the stone bounced painfully off Samson's forehead.

This was the moment when Samson's life hung in the balance. A few of the spectators, the ones who had jeered as he was led to the execution ground, picked up stones and tossed them at him. But they all rolled harmlessly past their target. The public mood was sombre, not bloodthirsty.

Sensing the possibility of an embarrassing anti-climax, the captain of guards gave a cryptic signal. Certain of the watchers, soldiers in plain clothes, picked up rocks and began ranting and cursing.

"Traitor! Heretic! Accursed infidel"! they yelled, hurling the boulders downwards.

It worked. Others were roused to participate. The stones rained down. More and more missiles found their mark.

Ada closed her eyes in horror as Samson's body sagged under the blows. Then his last anguished cry rang in her ears: "Mantissa, I love you"! But Mantissa was too far away to hear.

His body collapsed, lifeless, under a hail of boulders.

Eventually the crowd dispersed. Ada wiped a tear from her eye as she trudged slowly homewards, re-tracing the way they had dragged him.

Suddenly, she noticed at the wayside, the miniature apple tree he had called Zapple. It lay, unconsidered, where it had fallen from his grasp, its pot splintered, its roots open to the air, its frail branches bent and broken after surviving so many millions of miles. But its single fruit had not even been bruised: it hung just above the dust, gleaming in the sunlight.

She bent down.

"I wonder . . ."

Her tongue suddenly felt parched. The little apple looked so crisp, so refreshing.

She picked it up and pensively turned it over in her hand. Then at length she bit deep into its side, till the juice ran down her cheeks. As she did so, a strange feeling came over her . . .

© Richard Forsyth, 1981. □

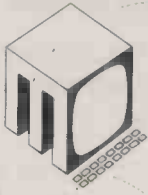

MICROPRO'S

latest from

METROTECH

*** NEW * WORDSTAR RELEASE 3 * NEW ***

Still only £255

New Features include:

- ★ Horizontal Scrolling
- ★ 240 column documents with no wraparound
- ★ Column move, delete and copy
- ★ Even friendlier user menus

*** NEW * SPELLSTAR OPTION * NEW ***

Single pass proof-reading against:

- ★ A 20,000 word main dictionary
- ★ Your own special dictionary

WORDSTAR 3.xx	£255/£30
MAILMERGE (option)	£ 60/£10
SPELLSTAR (option)	£125
WORDSTAR UPGRADE	£ 55

In addition Metrotech provides a true *English* dictionary with all American words deleted and replaced by English words.

For further details CALL

0895 58111 ext 247 or 269

or Write to

METROTECH MAIL ORDER

WATERLOO ROAD
UXBRIDGE
MIDDLESEX UB8 2YW

Wordstar is a trademark of Micropro.

**SUPERB
WALKIE
STEREO
VALUE
£70.00
MUST
BE
WON
PLUS
19 OTHER
PRIZES !!!**



HOW MANY TEN-PACKS ? ? ? ?

A Christmas offer from Mr. DISKING himself

Competition Rules:—

Simply study the photo' below and guess the number of empty Ten-Packs around me. Put this guess (one number only please) with your name, address and home 'phone number on my order form opposite, and post it, to reach me NOT later than December 31st 1981.

You may of course order my Disks and Accessories at the same time, but with regard to the competition, it is strictly one-person one-entry.

If my order form opposite has been removed, you may still enter on your own paper, but please mention in which magazine you saw this competition. I will inform all twenty winners in early January, and my decision will be fair and final.

The twenty closest guesses will receive the prizes listed below, with the most accurate winning the Walkie Stereo, and pro rata.

1st PRIZE— Walkie Stereo complete with featherlight headphones.

2nd PRIZE— Conviphone telephone with push-buttons and memory re-dial.

3rd-12th PRIZES— Ten DISKING Superluxe Disk Libraries (SDL's).

13th-20th PRIZES— Eight Gold plated Paper-Mate ballpoint pens.



Everyone who orders from DISKING is a winner, we are never knowingly undersold. Furthermore, we offer a full refund if not highly delighted with the goods. We wish all our customers, both regular and first-time buyers, a Very Merry Christmas, Happy Computing and good luck!

Roger S. Smith,
DISKING International, FREEPOST, Liphook, Hampshire GU30 7BR. Tel: (0428) 722563.

Sumlock Bondain Servicing. We know the system.

Sumlock Bondain know your computer. That's why it makes sense to have a maintenance contract with us. Then we can take care of your system on a regular basis. Or in the unlikely event of a breakdown we'll be with you well within 24 hours to solve the problem.

01-250-0505

So now you can take advantage of a total sales and service package from Sumlock Bondain.

We only sell the best systems – look at our range – so it makes good sense that we should want to look after them too.

Commodore PET, Apple, Northstar Horizon, Hewlett Packard, Shelton, Xerox Diablo, Sharp. In fact, you name a system and you'll be surprised how much we know about it.

See how we can help. Talk to us on 01-250 0505.



SUMLOCK BONDAIN LTD.

263 – 269 City Road, London EC1.

Telephone: 01-250-0505 Telex: 299844.

● Circle No. 276

Complete CP/M Business Systems from £3,200

Value for money the Shelton Signet range is unbeatable and so versatile. We are offering this low cost high performance microcomputer system in an attractive desk-top enclosure for only £3,200. Included in this price is the popular CP/M 2.2 disk operating system giving access to a wide range of software for all applications.

Some of its more interesting features are:

- * Indefinitely expandable to multi-user/multi-task
- * Silent operation of central system
- * Communications capability
- * Prestel compatibility available
- * High reliability level
- * Manufactured in the UK

SOFTWARE

Integrated Accounting System including Sales, Purchase and Nominal Ledgers, Inventory Control

Optional Packages for Word Processing, Financial Planning, Database Management, Payroll etc.

A small step today will bring big dividends tomorrow. For further information contact

SENTON

**27 St Nicholas Street
Bristol BS1 1TP
Tel (0272) 276132**

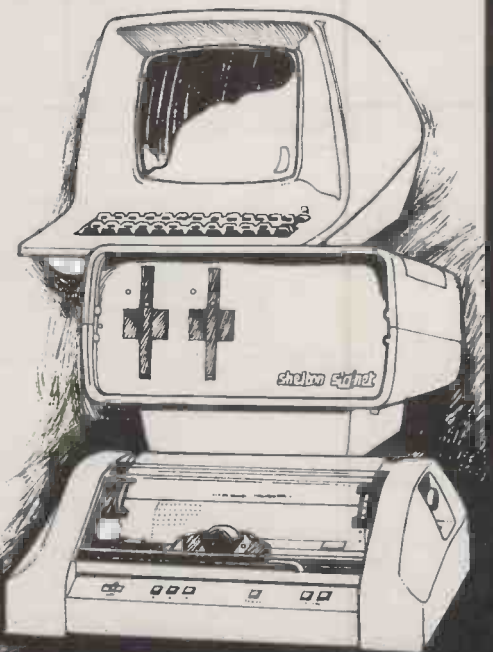

● Circle No. 277

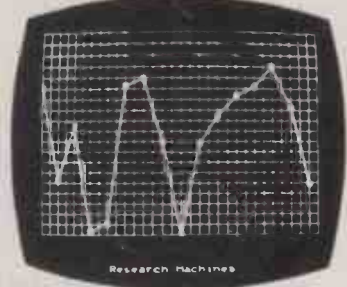
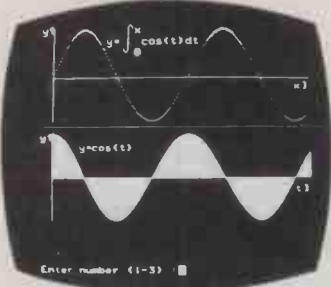
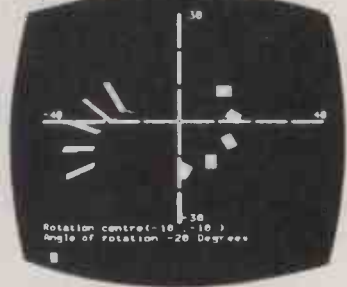
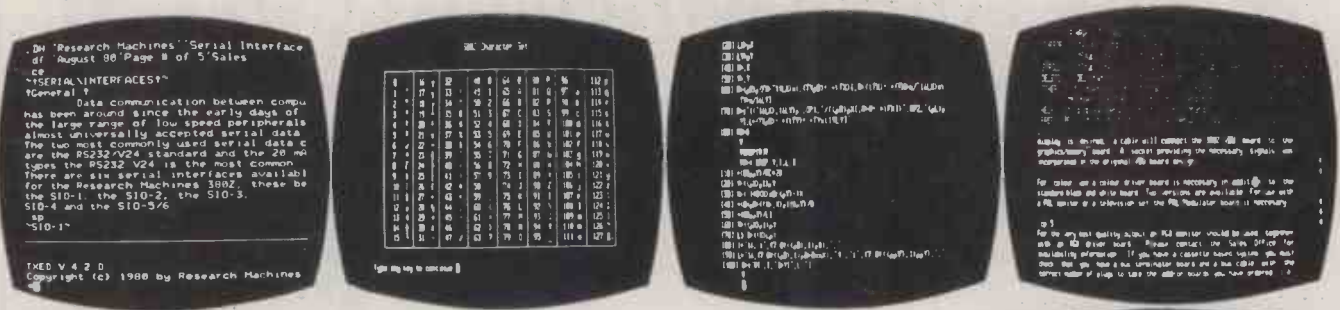

80/40 CHARACTER MACHINE

Providing exactly the right facilities for different applications can be a real problem when a system is as versatile as the 380Z.

Take, for example, screen line length. Not only do different users have different needs; so too do individual users.

They might welcome forty character clarity for presentation, display, and control applications; but they also want eighty character capacity, because word processing, some programming languages, and many general-purpose applications demand it.

So we've developed Varitext — to provide both, on the same machine.

Varitext means that the 380Z user can always choose the line length best suited to the application. It gives access to a growing range of 80 character software without losing all those well-established and popular 40 character applications. It makes the 380Z equally effective as a computer and a word processor. It lets programmers use the character mode with which they are familiar — or which languages like ALGOL, FORTRAN, and PASCAL really need.

And it improves the quality of our already exceptional graphics, by offering a smaller character size for neater annotation.

But the Varitext option goes a great deal further than that. We also saw it as the opportunity for a major enhancement of the 380Z's screen handling capabilities.

So we added:

- an 8 x 10 dot matrix, to further refine the character set;
- an additional set of 128 user-definable characters;
- reverse video, underlining, and selective character dimming;
- smooth scrolling and faster screen filling;
- user defined windowing (and independent scrolling) of screen areas;
- audible tone generation (option)

And all that, we believe, makes the 380Z's screen handling the best on the market.

The Varitext option is available with new systems or as a user-installable enhancement to existing 380Z systems. Contact our Sales Office for details.



RESEARCH MACHINES LTD Mill Street, Oxford OX2 0BW, Tel: (0865)49791

● Circle No. 278



FREE SOUND WITH VIDEO GENIE



CASE FOR OHIO SUPERBOARD OR UK101 ONLY £24
 IN PLASTIC OR IN STEEL! £37
 NUMBER PAD FOR ABOVE ONLY £12

WE CAN OFFER THE INCREDIBLE VIDEO GENIE FOR ONLY £279 INCLUDING SOUND! 32K EXPANSION INTERFACE FOR ONLY £279 AND 40 TRACK DISKS FOR ONLY £195 SINGLE AND £380 DUAL!



OHIO SUPERBOARD
 COMPLETE WITH SOUND, POWER SUPPLY, MODULATOR FULLY BUILT & TESTED FOR BRITISH T.V. STANDARDS ONLY **£159**



CENTRONICS 737 LETTER QUALITY PRINTER ONLY **£345**

PET — CENTRONICS FULLY DECODED INTERFACE NOW ONLY **£49**

APPLE — CENTRONICS INTERFACE ONLY **£79!**

ALL PRICES INCLUDE POSTAGE & PACKING BUT EXCLUDE V.A.T.
**KRAM ELECTRONICS, VICTORIA HOUSE,
 17 HIGHCROSS STREET, LEICESTER**

FREE POST (NO STAMP REQUIRED)

● Circle No. 279



CATCH THE TEMCY MULTI-BUS! IT'S AN 8085!

ACT NOW AND BEAT THE TRAFFIC QUEUE
 THAT'S WHAT TEMCY DOES

Twin 64K RAM 8085 microprocessors: Twin 4K of ROM: Twin 8" double sided/double density discs: green screen 26 x 80, low and high resolution display; 6 x 9 dots and 8 x 12 dots; true descenders, inverse, flashing underline outline, highlight, hidden and combination of these: twin RS 232C ports, asynchronous/synchronous transfer; printer centronics parallel: two additional disc drive ports: language TS Basic, optional CP/M(TM), Pascal M, Cobol -'80, Fortran '80, Macro -'80: Applications include word processing, intelligence terminal. Dealer inquiries welcome.

MANUFACTURED IN JAPAN BY: "Toa Microcomputer Inc."

FOR FURTHER INFORMATION CONTACT:
**Eastmead Computer Systems Ltd., Lyon Way, Frimley Road,
 Frimley, Surrey GU16 5EZ. Phone: 0276 682041/2, 0276 20122.
 Telex: 858894 EASTSMS.**

● Circle No. 280

"The best value for money on the small business systems market"

Which Computer? Jan '81

SUPERBRAIN

A smart, fully self-contained desk-top unit – that's the SUPERBRAIN microcomputer. It will operate as a complete business system, as a word processor (allied to a high quality printer) and as an intelligent terminal.

- 320K, 680K and 1.5 MB disc drives
- Wide range of standard packages
- Full graphics facility
- Nationwide dealer network



SUPERBRAIN is ideal for both first time buyers needing a general purpose machine, and for users wishing to upgrade from a personal microcomputer system. Its CP/M operating system will handle the most sophisticated programs. Twin Z80 microprocessors and an RS232 communications port make it easy to extend the system in the future.

The Icarus dealer network

ABRAXAS COMPUTER EMPLOYMENT, 357 Euston Road, LONDON NW1 3AL. Tel: 01 388 2061

A.P. LTD, Maple House, Mortlake Crescent, CHESTER CH3 5UR. Tel: 0244 46024

AMCO LTD, Playfair Road, LEEDS LS10 2GP. Tel: 0532 708321

BUSINESS INFORMATION SERVICES, 602 Triumph House, 189 Regent Street, LONDON. Tel: 01 437 1069

BUSINESS EFFICIENCY SYSTEMS, 9 Clarence Street, BELFAST 1, N. Ireland. Tel: 0232 647 538

BORDER COMPUTING LTD, Dog Kennel Lane, BUCKNELL, Shropshire. Tel: 054 74 368

CAMBRIDGE MICRO COMPUTERS, Cambridge Science Park, Milton Road, CAMBRIDGE. Tel: 0223 314666

COMMONSENSE COMPUTING LTD, P.O. Box 7, BIDEFORD, Devon. Tel: 02372 4795

CONQUEST COMPUTER SALES LTD, 92 London Road, BENFLEET, Essex. Tel: 03745 59861

CULLOVILLE LTD, Thornfield, Woodhill Road, SANDON, Chelmsford, Essex. Tel: 024 541 3919

DATA PROFILE, Lawrence Road, Green Lane, HOUNSLOW, Middlesex. Tel: 01 446 1917

DATA WARE, 48 Eaton Drive, KINGSTON, Surrey KT2 7QX. Tel: 01 546 2984

DAYTA, 20b West Street, Wilton, SALISBURY, Wilts. Tel: 0722 74 3898

DRAGON SYSTEMS LTD, Mansel Street, SWANSEA, W. Glam. Tel: 0792 749486

EASIBEE COMPUTING LTD, 133/135 High Street, LONDON E6 1HZ. Tel: 01 471 4884

ESCO COMPUTING LTD, 154 Cannongate, EDINBURGH. Tel: 031 557 3937

ESCO COMPUTING LTD, 40a Gower Street, GLASGOW G51 1PH. Tel: 041 427 5497

ELECTRONIC INFORMATION SYSTEMS, 91 Ashley Down Road, BRISTOL BS7. Tel: 0272 428165

E.M.G. MICROS, 30 Heathfield Road, CROYDON, Surrey. Tel: 01 688 0088

EMTEK, 40 South Furzeham Road, BRIXHAM, Devon. Tel: 08045 3566

FARMFAX LTD, 17 Hylton Road, PETERSFIELD, Hants. Tel: 0730 66123

FOREST ROW COMPUTERS, 53 Freshfield Bank, FOREST ROW, East Sussex. Tel: 034282 4397

G.T. OFFICE SYSTEMS, 12 Clovelly Road, LONDON W5 5HE. Tel: 01 567 9959

JAEMMA LTD, Unit 24, Lee Bank House, Holloway Head, Lee Bank, BIRMINGHAM. Tel: 021 643 1609

JENNINGS COMPUTER SERVICES, 55/57 Fagley Road, BRADFORD, W. Yorks. Tel: 0274 637867

LONDON COMPUTER CENTRE, 43 Grafton Way, LONDON W1. Tel: 01 388 5721

MICROAGE LTD, 53 Acton Road, LONG EATON, Nottinghamshire. Tel: 06076 64264

MICRO-K, 186 Martin Way, MORDEN, Surrey. Tel: 01 543 1119

MICRO SOLUTION LTD, Park Farm House, Heythrop, CHIPPING NORTON, Oxon. Tel: 0608 3256

MITESH MICROSYSTEMS LTD, 66 Wootton Drive, Grove Hill, HEMEL HEMPSTEAD, Herts. Tel: 0442 40341

NORTHERN COMPUTERS LTD, 128 Walton Road, Stockton Heath, WARRINGTON. Tel: 0925 601683

OFFICE COMPUTER TECHNIQUES, Peacock House, 52 Vaughan Way, LEICESTER. Tel: 0533 29631

OMEGA ELECTRIC LTD, Flaxley Mill, Flaxley Road, MITCHELDEAN, Glos. Tel: 045 276 532

MICROCOMPUTER SPACEDROME, 12 Dene Road, Southgate, LONDON N11 1ES. Tel: 01 368 9002

RANMOR COMPUTING LTD, Nelson House, 2 Nelson Mews, SOUTHBEND-ON-SEA. Tel: 0702 339262

ROGIS SYSTEMS LTD, Keepers Lodge, Frittenden, NR. CRANBROOK, Kent. Tel: 058 080 310

S.D.M. COMPUTER SERVICES, Broadway, BEBINGTON, Merseyside L63 5ND. Tel: 051 608 9365

S.M.G. MICROS, 39 Windmill Street, GRAVESEND, Kent. Tel: 0474 55813

SAPPHIRE SYSTEMS, 19-27 Kents Hill Road, BENFLEET, Essex. Tel: 03745 59756

SHEFFIELD COMPUTER CENTRE, 225 Abbeydale Road, SHEFFIELD S7 1FJ. Tel: 0742 53519

SORTFIELD LTD, E. Floor, Milburn House, Dean Street, NEWCASTLE-UPON-TYNE. Tel: 0632 329593

SPOT COMPUTER SYSTEMS LTD, New Street, Kelham Street Indus. Estate, DONCASTER, S. Yorks. Tel: 0302 25159

STUKELEY COMPUTER SERVICES, Barnhill, STAMFORD, Lincs. Tel: 0780 4947

TERMACRE LTD, 126 Woodwarde Road, LONDON SE22 8TU. Tel: 693 3037

THAMES VALLEY COMPUTERS, 10 Maple Close, MAIDENHEAD, Berks. Tel: 0628 23532

TURNKEY COMPUTER TECHNIQUE, 23 Caldergreen Road, St. Leonards, EAST KILBRIDE. Tel: 03552 39466

WELSH BUSINESS SYSTEMS LTD, 1 Windsor Chambers, Windsor Arcade, PENARTH. Tel: 0222 700059

WING SYSTEMS LTD, 406 Winchester Road, SOUTHAMPTON. Tel: 0703 768338

For further details, or if you want to become a dealer yourself, contact:

ICARUS

Computer Systems Ltd.

Icarus Computer Systems Ltd. Deane House 27 Greenwood Place London NW5 1NN Tel: 01-485 5574 Telex: 264209

● Circle No. 281

Aurac Control Systems

The name is new but our work in computer systems software spans over a decade, both in Britain and abroad. Our associates have equivalent qualifications in the field of digital electronics.

Our experience covers a broad variety of software and hardware, from large IBM Operating Systems such as OS and VM/370 to the little but extremely effective Apple Microcomputer.

We are independent. We are not committed to any particular manufacturer or supplier. This means that we recommend what we believe to be the most appropriate and cost-effective solution to **YOUR** specific problem.

And because we are small your costs need not be sky-high.

We offer

- Consultancy and professional advice
- Feasibility studies
- Programming in high/low level languages, eg Basic, Pascal, IBM BAL, machine code
- Microprocessor controlled industrial systems
- Courses: from management appreciation to detail programming

Aurac Control Systems

12a Baldwin Street, Bristol BS1 1RZ
Tel: Bristol (0272) 292966/827998

● Circle No. 282



**CRYSTAL ELECTRONICS
CC ELECTRONICS**

XTAL BASIC

**FOR Z80 MACHINES
including SHARP and NASCOM**

Home brew	£35 + VAT
NASCOM version	£35 + VAT
SHARP version	£40 + VAT

NASCOM and SHARP approved product

NEW! The HACKS guide to the innards of XTAL BASIC £7.50.

For new and existing owners of XTAL BASIC — explains sub-routines and working of XTAL BASIC Interpreter.

SHARP is a registered trade mark of SHARP CORPORATION, JAPAN.
NASCOM is a registered trade mark of LUCAS LOGIC

Members of Computer Retailers Association & Apple Dealers Association

Shop open 0930-1730 except Saturday & Sunday

40 Magdalene Road, Torquay, Devon, England. Tel: 0803 22699

Access and Barclaycard welcome.



COMPUTERS
AND
COMPONENTS



● Circle No. 272

BUYING A NASCOM?

Free Statistical Calculator with every Nascom item costing more than £90.
Features include Memory, Square Root, Percent and Statistical Keys.

i.e. With a Nascom II with RAM B board you get two Statistical Calculators.

The HS-1N Fast Mini-Cassette Data Storage System is now only £199 for a single drive system (down from £230). It comes complete with Philips Mini Cassette Drive, Interface Board, Firmware, Manual, Cassette... Everything you need. Transfer speed 6000bps, storage 56k per side. The Fast Tape System that "looks" like a disk drive. As in "Making Tracks" PCW May '81 issue.

Beat our component prices if you can...

4116 (250nS) 73p

2114 (250nS) 1.07p

Plus excellent prices on... 74 and 74LS TTL and CMOS
All prices ex VAT. Please send 25p p&p for components.

Micro-Spares

19 Roseburn Terrace, Edinburgh EH12 5NG.
Tel: 031-337 5611.



● Circle No. 283

NewBear Limited

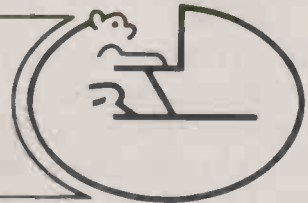

sharp operators go to Newbear



Newbear is the biggest Sharp dealer in the country.

FOR THE MZ-80K HARDWARE

- MZ80-K 48K COMPUTER
- MZ80K-FD DUAL DISC UNIT
- M280K-P3 PRINTER
- MZ80K-5 SLOT I/O BOX
- BI-DIRECT. V24/RS232 CARD
- UNIVERSAL I/O CARD
- RS232 O/P BOX WITH PSU
- (SINGLE DIRECT NO I/O BOX REQD. O/P ONLY)

**PHONE
FOR
LATEST
PRICES**

UTILITY PACKAGES

APOLLO WORD PROCESSOR	£24.95	CRYSTAL BASIC	£40.00
MEMORY TEST	£5.50	SUPER COPY	£10.50
CASSETTE DATABASE	£29.50	PROGRAM FILING INDEX	£5.50
BASIC EXTENSIONS	£13.00	MUSIC COMPOSER-EDITOR	£10.50
ARDENSOFT TOOLKIT	£35.00	DOUBLE PRECISION BASIC FOR THE	
CP/M KIT	£150.00	MZ80K DISC SYSTEM	£40.00
ZEN EDITOR/ASSEMBLER	£19.50	PASCAL (CASSETTE)	£50.00
SHARP EDITOR/ASSEMBLER	£45.00	MZ80-K CAL CH	£34.50
ZEN-DOS DISSASSEMBLER	£37.50	(FINANCIAL MODELLING)	
SHARP MACHINE CODE TAPE & MANUAL	£22.50		
DISSASSEMBLER	£10.50		

MZ80-K MANUALS & ACCESSORIES

MONITOR LISTING (COMMENTED)	£15.00
BASIC 5025 MANUAL	£7.00
MZ80-K SERVICE MANUAL	£7.50
MZ80-1/O SERVICE MANUAL	£5.00
MZ-80P3 SERVICE MANUAL	£7.50
MZ-80FD SERVICE MANUAL	£10.00
MZ80-K DUST COVER	£9.95

GAMES BOOKS. WORD PROCESSING. EDUCATION PRINTERS. DISCS. + THE LATEST MZ-80B!

GAMES			
ANIMATE	£5.50	GUESS WORD	£5.50
BLOCKADE	£5.50	GUN	£5.50
BOMBER	£5.50	HANGMAN	£5.50
BREAKOUT	£5.50	HEADON	£5.50
CAMELOT	£5.50	HOME BUDGET	£5.50
CAROLS	£5.50	HUNTER KILLER	£5.50
CATCH 2000/INVADER	£5.50	INTRUDER	£5.50
CHESS	£10.50	J.S. LINE 4	£5.50
COMBAT	£5.50	LARGE DISPLAY	£5.50
CONCENTRATION	£5.50	LIFE	£8.00
COSMIO 12K	£8.00	LUNAR	£5.50
CRIBBAGE	£10.50	LUNAR LANDER	£5.50
DONKEY DERBY	£5.50	MAP OF ENGLAND	£5.50
ELECTRONIC ORGAN	£5.50	MASTERMIND	£5.50
ENIGMA	£5.50	MIZ MAZE	£8.50
EVASION	£5.50	MONKEY CLIMB	£5.50
EXECUTIVE	£8.00	MORTAR ATTACK	£5.50
EXPLORING AFRICA	£5.50	PATIENCE	£5.50
FALL OUT	£5.50	POKER	£5.50
FIREBALLS	£5.50	PONTOON	£5.50
4 INAROW	£5.50	PRINCESS MAZE	£5.50
FRUIT MACHINE	£5.50	30	£5.50
GRAPHICS/MUSIC PACK	£5.50	QUADRAX	£5.50
TYCOON	£5.50		
		RACING	£5.50
		RACETRACK	£5.50
		RAIDER	£5.50
		REACTOR	£5.50
		ROAD HUNTER	£8.00
		RHYMES	£5.50
		SHAPEMATCH	£5.50
		SHARP DEMO(GRAPHICS)	£5.50
		SHOWJUMPING	£5.50
		SNAKES & LADDERS	£5.50
		SPACE BATTLE	£5.50
		SPACE INVADERS	£5.50
		SPACE PURSUIT	£5.50
		STAR TREK	£5.50
		STOMPER	£5.50
		SUBMARINE	£5.50
		SUPER FIRE	£5.50
		SUPER SIMON	£5.50
		SWORSMAN	£8.00
		TANKWARP/WALL	£5.50
		TEN PIN BOWLING	£5.50
		TRADER SMITH	£8.00
		U.F.O.	£5.50

EDUCATIONAL PACKAGES

MUSIC COMPOSER EDITOR	£10.50	'A' LEVEL	
TIMETABLING AID	£19.50	ELECTRONS	£10.50
CHILDRENS MATHS	£5.50	WAVES	£10.50

CESIL	£14.95
FRONT PANEL	£t.b.a.
AS THE CROW FLIES	£t.b.a.
BROWNIAN MOTION	£10.50

AND MUCH MORE COMING!

**SEND
FOR FULL
CATALOGUE**

Please add V.A.T. to all prices

Newbear Limited (Head Office) 40 Bartholomew Street, Newbury, Berks. Tel: (0635) 30505. Telex: 848-507 NCS.
Newbear Limited. First Floor Offices: Tivoli Centre, Coventry Road, Birmingham. Tel: (021) 707-8255
Newbear Limited. Stockport Road, Cheadle Heath, Manchester. Tel: (061) 491-2290

Please send me details of _____

Name _____

Company _____

Address _____

● Circle No. 284

Apple users!

Keep up to date with the rapidly changing world of the Apple with a subscription to the British Apple users' magazine, Windfall. For £12 for 12 issues (post free) you will learn how to make your Apple more powerful and your programs more exciting and be the first to know what's coming next in Apple-compatible hardware and software.

Two special Windfall offers for readers of Practical Computing

T-SHIRT
ONLY £2.99
 + 30p p&p

SWEAT SHIRT
ONLY £5.99
 + 30p p&p

Both with the Apple logo in six colours!



TO: Windfall, 68 Chester Road, Hazel Grove, Stockport SK7 5NY.

Please send the following:

12 months subscription to Windfall – £12

..... Apple T-shirts at £3.29 each

..... Apple Sweat shirts at £6.29 each

TOTAL

Small Medium Large Extra Large
 34"-36" 36"-38" 38"-40" 40"-42"

Please tick size required

NAME _____

ADDRESS _____

SIGNED _____

Please charge my credit card:



Name of card _____



Number _____

You can order **061-456 8353**
 by telephone: (24-hour answering service)

● Circle No. 285

MICROLINK MICROLINK MICROLINK

The flexible interfacing system for your **Commodore PET or HP 85.**

The Microlink interface makes it easy to use your micro for tasks such as:

- * Replacing chart recordings by computer analysis.
- * Automating experiments * Adding data processing capability to monitoring instruments.

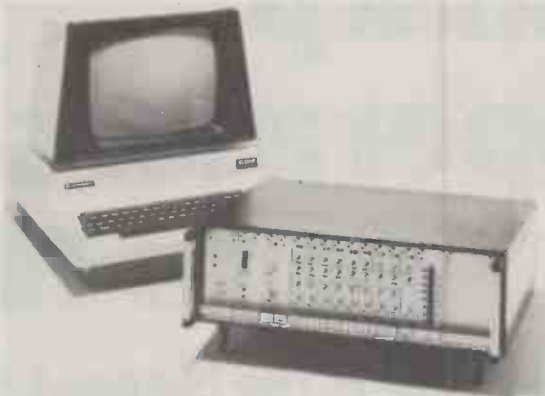

The MICROLINK interface consists of a mainframe incorporating a power supply, an IEEE 488 interface and a cabinet holding up to 10 modules – this construction means that an interface can be configured to your precise requirements. Modules available include: * Analogue to digital converters * Digital to analogue converters * Analogue X-Y plotter driver * Analogue input conditioning modules * Relay outputs * BCD character inputs * Signal conditioning inputs * High speed clock and multiplexer.

Write or telephone with details of your application, and we will quote you for a configuration to meet your needs.

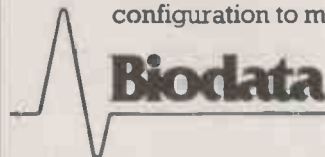

Biodata Ltd., 6 Lower Ormond St., Manchester M1 5QF.
 Telephone: 061-236 1283.

MICROLINK MICROLINK MICROLINK

● Circle No. 286

ONLY FROM CPS

CBM 8024 WITH IEEE, RS 232C, OR CENTRONICS COMPATIBILITY

FROM £925.00

OLYMPIA SCRIPTA



The Olympia Scripta daisywheel printers have a wide selection of super-sharp typestyles and are renowned for lasting reliability.

Scripta R0
£826 +VAT

Scripta KSR
£990 +VAT

Free Interface
of your choice when
you buy a Scripta!

IEEE → Centronics
IEEE → RS232C
RS232C → Centronics

including Apple, Serial
and Parallel cards.

RUTISHAUSER

Cutsheet feed → Qume
£525 +VAT

Tractor feed → Qume
£145 +VAT

CPS ARE THE SOLE SUPPLIERS OF THIS UNIQUE PRINTER which has our own factory-fitted adaptations for RS232C, or Centronics compatibility. The CBM8024 operates at 160cps, with ASC11 96 character set on tractor-fed continuous fan paper giving an original and up to 4 copies on paper from 4 to 15" wide. Ideally suited to accounting, mailing lists, address labelling etc.



IEEE COMPATIBLE £925 +VAT
CENTRONICS COMPATIBLE £945 +VAT
RS232C COMPATIBLE £965 +VAT

QUME SPRINT



45 cps daisywheel printer with 96 characters, and 10, 12, 15 pitch or proportional spacing. Gives up to 10 extremely crisp copies.

5/45 R0 £1545 +VAT

CBM 32K4000 Series



£555 +VAT

**CPS ARE DISTRIBUTORS FOR
Panasonic: Cifer: Apple: Commodore**

DEALER ENQUIRIES WELCOME FOR ALL LISTED ITEMS
For all information and sales phone Nick Ashburner

OKI Microline 83



RS232 interface or Centronics compatible. Friction and pin feed, 120 cps with 4 character sizes. 96 character set with 64 block graphics.

£695 +VAT

RICOH 1600S

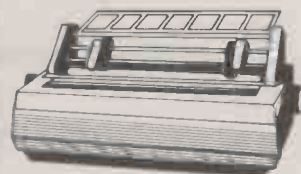

Available with IEEE, RS232C or Centronics compatibility.

£1450 +VAT

WABASH Floppy Discs

5¼SSDD including plastic library case
£19.95 +VAT

**QUANTITY
DISCOUNTS**

Phone us for the latest discounts on all 5¼ and 8" Discettes, including special formats!



CPS (DATA SYSTEMS) LTD

Third Floor, Arden House, 1102 Warwick Road,
Acocks Green, Birmingham B27 6BH.

Telephone: 021-707 3866

Telex: 312280 CPS G

A member of the CPS Group

● Circle No. 287



TRS-80 OWNERS!



LEVEL II CASSETTE GAMES

Adventures:	
Special Sampler*	£6.50
Adventureland*	£13.50
Pirates Adventure*	£13.50
Mission Impossible*	£13.50
Voodoo Castle*	£13.50
The Count*	£13.50
Strange Odyssey*	£13.50
Mystery Fun House*	£13.50
Pyramid of Doom*	£13.50
Ghost Town*	£13.50
Kid Venture*	£13.50
Savage Island*	£13.50
Crowley Manor*	£13.50
Air Raid*	£7.50
Air Traffic Control*	£8.50
Aimz'n' Mazes	£5.50
Android NIM	£7.50
Backgammon*	£10.50
Barricade*	£7.50
Battle Bastogne	£10.50
Battle St. Vith	£10.50
Battleship	£7.50
Bee Wary	£7.50
Bingo	£5.00
Bowling (Ten Pin)	£6.50
Bridge Partner	£13.50
Chess Partner*	£9.50
Cosmic Fighter*	£10.50
Cribbage	£6.50
Datestones of Ryn	£17.50
D-Day	£10.50
Death Dreadnaught*	£10.50
Duel & Droids	£10.50
The Empire Strikes	£10.50
End Zone II	£6.50
Fastgammon*	£14.00
Galactic Empire	£10.50
Galactic Revolution	£10.50
Galactic Trader	£10.50
Galaxy Invasion*	£10.50
Game of Life*	£6.50
Gammon Challenger*	£10.50
Gangster	£5.50
Hangman	£5.50
Hellfire Warrior	£20.50
I Ching	£6.50
Interlude*	£12.00
Invasion Orion	£17.50
Invaders from Space*	£10.50
Kamikaze	£6.50

Kriegspiel II	£10.50
Labyrinth*	£10.50
Life Two	£10.50
Lost Dutchman's Gold	£9.50
Lunar Lander*	£10.50
Mean Checkers*	£11.00
Meteor Mission*	£10.50
Morloc's Tower	£17.50
Noughts & Crosses	£5.00
Othello III	£6.50
Olympic Decathlon*	£20.50
Pentominoes	£6.50
Pinball*	£10.50
Pork Barrel	£6.50
Planetoids*	£10.50
PR Dogfight	£6.50
Rescue at Rigel	£17.50
Reversi	£20.50
Round The Horn	£6.50
Safari	£6.50
Sargon II*	£20.50
Snake Eggs	£7.50
Space Battles	£7.50
Starfleet Orion	£14.00
Startrek III.5	£10.50
Super Nova*	£10.50
Taipan	£6.50
Temple of Asphai	£17.50
Time Trek*	£10.50
Trolls Gold	£4.50
Turret & Track	£7.50
Up Periscope	£10.50
Warfare I	£6.00
Warpath	£10.50
X-Wing Fighter II	£7.50

EDUCATIONAL

Spelling Builder	£13.00
All other PDI Pgms	£10.50
Teachers Assistant I	£9.50
Teachers Assistant II	£9.50
Teachers Assistant III	£9.50
Semi Conductor Theory	£9.50
9 Games for Preschoolers	£7.50

BUSINESS & UTILITIES

Accounts Receivable II	£13.50
Amateur Astronomer	£9.50
APL 80*	£10.50
Basic 1P*	£11.50
Basic Toolkit*	£12.50
Biorythms	£5.50
Calendar Functions	£7.50
Cash Register	£6.50
Copsys*	£10.50
Data Base II	£17.00
Debug*	£13.50

Direct Function Graph	£10.50
Editor Assembler Plus*	£20.50
Electric Pencil*	£50.00
Electronics Assistant	£7.50
EMU 02* (requires TBUG)	£17.00
ESP Tester	£7.50
File Handling	£5.00
Finance Pack	£7.50
Finplan	£35.00
Flight Simulator*	£17.00
Forth* (incl. Primer)	£42.00
GSF*	£19.50
General Accounting	£8.50
Ham Radio	£7.50
Histogram/Scattergram	£8.50
Home Finance	£6.50
Infinite Basic*	£34.00
Infinite Business*	£20.50
Instant Calculator	£8.50
Inventory Control	£11.00
Inventory 'S'	£17.00
IRV*	£17.00
Keyboard 80*	£7.50
KVP*	£10.50
Level III Basic*	£34.00
Linear Programming	£7.50
Magic Paper Calculator	£9.50
Mathdrill	£5.50
Maths Library I	£10.50
Maths Library II	£10.50
Memdump*	£8.50
Mortgage Calculator	£5.00
Pascal*	£26.00
Periodical X-REF	£10.50
Personal Finance	£7.50
Pilot 2.2*	£10.50
Pre-Flight	£10.50
Remodel & Proload*	£25.00
Renumber*	£7.50
RPN Calculator	£7.50
RSM 2 Monitor*	£16.00
SCRIPSI*	£42.95
Screen Hold*	£6.00
Statistics	£6.50
S.T.A.D.*	£17.00
ST-80*	£34.00
Super Pims Data Base	£10.50
Super Simon	£7.50
Super T-Legs*	£7.50
T-Step*	£7.50
System Copy*	£9.50
T-Short*	£6.50
T-Short**	£14.00
Tarot Cards	£6.50
Timser*	£10.50

Tiny Comp	£14.00
TRS80 Opera*	£7.50
Typing Tutor	£13.50
Ultra Mon*	£17.00
X-Ref*	£9.50
Y-Y Bar	£10.50
76 Basic Programs	£23.00
Manual for Above	£8.00
Library 100	£40.00

DISK

Accounts Receivable II	£40.00
Advanced Personal	£40.00
Finance	£17.00
Amateur Radio System	£17.00
APL 80	£30.00
Auto-Disk Directory	£10.50
Basic Compiler	£120.00
Cash Register + Inventory	£40.00
CCA Data Management	£52.50
Comproc	£13.50
Data Base II	£30.00
DCV-1	£9.50
Dosort	£25.00
Dynamic Data Base	£22.50
Electric Pencil	£75.00
File Manager 80	£30.00
Floppy Disk Diagnostic	£13.50
Forth (incl. Primer)	£45.00
Forth Datahandler	£40.00
Forth Utilities Disk	£27.50
Inventory Control	£50.00
Inventory 'S'	£40.00
KVP Extender*	£17.00
Mailist IV	£45.00
Mychess	£25.00
Newdos 80 V2.0	£97.50
Newdos +	£47.50
Office Accounting	£20.00
Pascal	£35.00
Penpatch	£11.00
Pencil PAL	£17.00
Roots	£20.00
RSM 2D Monitor	£25.00
Sargon II	£25.00
SCRIPSI*	£65.00
Simplify It	£15.00
Space Intruders	£20.00
ST80D*	£45.00
ST80D III*	£95.00
SUPERSCRIPT*	£20.50
Visicalc*	£65.00
Taranto & Associates Conversion of Osbourne & Associates Business Programmes	£90.00
Accounts Payable	£90.00

Accounts Receivable	£90.00
Invoicing for above	£70.00
General Ledger	
includes Cash Journal	£90.00
Manuals for above (3)	£32.00
Complete Co-ordinated System with Manuals	£300.00

MODEL II

CPM 2.2 X	£165.00
CBasic (CPM)	£80.00
Disk Sort Merge	£95.00
Development System	£80.00
G.S.F.	£35.00
Pascal	from £125.00
Reference II	£35.00
RM Cobol	from £350.00
RSM II Monitor	£35.00
Supersort III (CPM)	£90.00
Utility Package	£95.00
Hard Disk Operating Sys	£300.00

WORD PROCESSORS

Electric Pencil II (CP/M)	£200.00
Electric Pencil II TRSDOS	£225.00
Magic Wand (CP/M)	£230.00
Wordstar (CP/M)	£275.00

BUSINESS SYSTEMS

Accounting	from £150.00
Mailist	from £100.00
Medical	from £100.00
Property Analysis	£175.00

CP/M USERS GROUP

23 Volumes	Each £12.00
------------	-------------

ALL PRICES INCLUDE VAT AT 15%, PACKAGING & RETURN POSTAGE TO U.K. ADDRESSES. PRICES TO OVERSEAS ADDRESSES INCLUDE RETURN AIRMAIL. SEND £1.00 FOR NEW DESCRIPTIVE CATALOGUE.

*Denotes Machine Language TRS-80 Trademark of Tandy Corp. CP/M Trademark of Digital Res. C-Basic Trademark of Compiler Systems.

ALL PRICES SUBJECT TO CHANGE WITHOUT NOTICE

MICROCOMPUTER APPLICATIONS

42A CHURCH STREET, CAVERS HAM, READING RG4 8AU, ENGLAND. TEL: (0734) 470425

THE AMAZING VIC 20 HOME COMPUTER FOR CHRISTMAS!

FOR ONLY £159.95 (excl. VAT)

Here is one present all the family could use. The VIC 20 is a fully fledged computer that simply plugs into your television receiver.

VIDEO GAMES

EDUCATIONAL COMPUTING

HOME AND BUSINESS PROGRAMS

PLUS MANY EXTRAS



We will not knowingly be undersold.

DATALECT COMPUTERS

Showrooms: 7, St. Georges Walk, Croydon, Surrey. 32, Chertsey Rd., Woking, Surrey GU21 5BG

At an incredibly low price of £159.95, it can help the children with their computer studies, handle business and home budgeting or you can relax and play space invaders or one of the many video games soon to be available. Dealer supplies of the VIC 20 are limited, make sure you're one of the first owners of

the VIC 20. Fill in the coupon TODAY or give us a ring on Woking (04862) 63901 or Croydon 01-680 3581.

I would like to order the VIC 20 Home Computer. (Quantity)
Please charge my ACCESS/VISA PC account no: _____

Name _____
Address _____
Post Code _____

DATALECT Computers. (Formerly Petalect). 33/35 Portugal Road, Woking, Surrey GU21 5JE

● Circle No. 288

Rent a Computer

Did you know you can rent a computer for as little as £2.76 per week (COMMODORE VIC)

Minimum Rental 12 months. Written quotation on request. Please phone for details.

... Monitors & TV's ...

COLOUR TV'S BY

FERGUSON, J.V.C.,
MITSUBISHI,
PANASONIC,
TOSHIBA.

PANASONIC TC492
Colour TV 12" £199.00
MITSUBISHI B/W 12" TV
£54.90



MONITORS

9" O.P.C. GREEN £95.00
9" APF B/W £85.00
9" HITACHI B/W £112.17
12" BMC £180.00
12" NEC GREEN £159.00
12" NEC COLOUR £579.00
14" DECCA COLOUR RGB £250.00

(Please add VAT to prices above)

..... Hardware

SYSTEMS BY
ADLER, APPLE,
COMMODORE VIC,
PANASONIC, SHARP,
VIDEO GENIE.



SHARP
PC1211 POCKET £79.00
SHARP MZ80K (48K) £354.00
(inc. £25 free software)
SHARP MZ80K(64K) £999.00

TANTEL PRESTEL ADAPTOR

Add Prestel to your computer in full colour. Can be used with any TV set. No colour card required.
GPO Approved £170.00
Alpha Numeric Version £199.00
APPLE 11 (48K) £695.00
ADLER SYSTEMS FROM £1550.00
VIDEO GENIE (16K) £295.00
COMMODORE VIC 20 £199.00
(inc. £25 free software)
VIDEO GENIE Model 2 £355.00

ALL ABOVE PRICES INCLUSIVE OF P&P
Please add VAT.

COMPUTER ACCESSORIES

C12 Digital Cassettes. Box of 10 £7.90
5 1/4 Discs Single Sided Double Density. Box of 10 £20.00
5 1/4 Double Sided Double Density. Box of 10 £32.00
SHARP Speed Basic £10.00

Please add P&P (77p) & VAT for above accessories

Mail Order Accessories

All items listed are available through our fast efficient mail order service. If you find our prices are not competitive then we will be pleased to match any genuine offer in this magazine.
P & P Rates: a 0.75, b 1.00, c 1.50, d 2.50

ACORN

Floating Point Rom 20.00 a
Memory Chips ea 1.95 a
Magic Book 5.50 c
Printer Drive 9.00 a
Printer Buffer 2.50 a
Utility 10.00 a
VDU 10.00 a
Maths Pack 10.00 a
Games Packs 1 to 7 10.00 a
Word Pack Rom 26.00 a

APPLE

(Please ring for software not listed)

Visicalc (new 16 sector) 111.00 b
Visiplot 100.00 b
Visitrend/Visiplot 144.00 b
Visidex 111.00 b
Ciscobol 475.00 b
Desk Top Plan 65.00 b
Micro Modeller 425.00 b
APM 121.00 b
Writer 39.00 b
Magic Window 79.00 b

BOOKS

(Send SAE for full list)

Acorn Magic 5.50 c
Microsoft Basic 8.95 c
Basic Basic 8.25 c
Learning Level II 11.00 c
Basic Handbook 11.00 c
Introduction to Pascal 8.75 c
Programming in Pascal 6.95 c
CP/M Handbook 8.95 c
Programming & Interfacing
65 02 8.95 c
Programming the 65 02 9.10 c
Basic Computer Games 5.50 c
Basic A Unit for
Secondary Schools 4.45 c
More Basic Computer Games 6.25 c
Making Most of ZX80 6.95 c
Machine Language
from ground up 9.00 c
Getting Acquainted with
your VIC 20 5.95 c
Getting Acquainted with
your Acorn Atom 7.95 c
ZX81 Companion 7.95 c
ZX81 Pocket Book 4.95 c

MEMORY CHIPS

4116 (Apple, Sharp) ea 1.50 a
2114 (Acorn) ea 1.95 a
4027 (1/2 K Sharp) ea 0.50 a

VIDEO GENIE

Sound Mod 7.50 a
Colour Mod 39.46 b
Synthesiser 45.00 b
EG 3013/RS232 215.00 d
Lower Case 35.00 b
Dust Cover 5.55 a
Invaders 13.00 a

Please add P & P and then VAT at 15%
(Zero-VAT on Books)

Biorhythm 7.50 a
Battle Of Britain 13.50 a
Pinball 13.00 a
Pools 13.50 a
Imon 23.10 a
Sargon II chess 25.00 a
Startrek 9.50 a
Z chess 3 14.50 a
Adventure Sampler 6.50 a
Adventure 1 to 9 8.75 a
Haniball 13.50 a
Android Nim 8.75 a
Tables 6.50 a

SHARP

CE 121 Cassette Interface 11.50 b
CE 122 Printer Interface 63.90 b
Assembler Tapes & Manual 23.44 b
Machine Language tape &
Manual 41.40 b
Pascal Interpreter (MZ80K) 50.00 b
Speed Basic 10.00 a
Biorhythm 4.00 a
Autocross 4.00 a
Hanoi 4.00 a
Fox & Geese 4.00 a
Four In a Row 5.00 a
Moonlander 5.00 a
Composer 4.00 a
Bank Account 5.00 a
Posiedon 4.00 a
Address Book 3.00 a
Anagrams 5.00 a
Dust Cover 5.00 a
P3 Printer Dust Cover 5.00 a
Picture Count 5.00 a
Count & Add 5.00 a
Match the Word 5.00 a
Character Match 5.00 a
Head On 6.00 a

SUPERIOR SYSTEMS SOFTWARE

SHARP
Games Pack 1
(5 games on Cassette) 10.00 a
Games Pack 2
(5 games on Cassette) 10.00 a
CALCUBET — Complete Bookmaker
Bet Calculation programme,
various versions available.
Phone for details.
**MAKE YOURSELF A
FORTUNE!**
CALCUSHARE Stock Market
program. Keeps control of up
to 50 shares. Traditional buy
& sell indicators. £50.00

APPLE

Games Pack 1
(Disc 5 games) 12.50 a
Games Pack 2
(Disc 5 games) 12.50 a
VIDEO GENIE
Games Pack
(5 games on Cassette) 10.00 a
Education Pack 1
(3-6 year old on Cassette) 10.00 a

Peripherals

PRINTERS

SEIKOSHA GP80 £195.00
EPSON MX80F/T £399.00
MICROLINE 80 £299.00
MICROLINE 83A £799.00
CENTRONICS 737 £395.00
SHARP MZ80P3 £379.00
SHARP MZ80P5 £415.00
EPSON MX100 £575.00
EPSON MX130 P.O.A.
EPSON MX80F/T2 £480.00



DISK DRIVES

SHARP DUAL DRIVE £580.00
VIDEO GENIE SINGLE DRIVE £215.00

INTERFACE UNITS

A WIDE RANGE OF INTERFACES ARE
AVAILABLE EX-STOCK
WESTRA COMPUTER STATION
DESKS IN STOCK

(Please add VAT to prices above)

Interest Free and Lease Purchasing Plan

3 MONTHS INTEREST FREE
CREDIT AVAILABLE ON ALL
ITEMS OVER £300. PLEASE
PHONE FOR DETAILS. LEASE
PURCHASE SYSTEMS FOR AS
LITTLE AS £10 PER WEEK!

193

Superior Systems Ltd.

178, WEST STREET, SHEFFIELD S1 4ET TEL: 0742 755005

ALSO AT: QUADRAPHENIA, 19 BRADFORD ROW, (HALLGATE) DONCASTER

DN1 3NF TEL: 0302 21215

Business Hours: Sheffield Mon-Sat 9am-5.15pm Doncaster Mon-Sat 10am-5.00pm

Circle No. 26



LONDON COMPUTER CENTRE

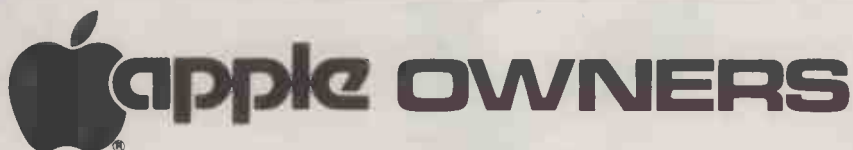

Convert your Apple to 80 column and 64K memory

SPECIAL OFFER!

Double vision 80 column board with true decoders 16K Ramcard and Easywriter 80 word processor

special price £250

The best Database manager! DBASE II with CP/M Z80 softcard

special price £350

8 Megabyte Hard Disc complete with controller and Interface

£1850

Apple II 48K Dual 40 Track Disc Drives and 12" green screen

monitor £1395



43 GRAFTON WAY, LONDON W1P 5LA (Opposite Maples)
Tel: 388 6991/2 OPENING HOURS: 11-7 MON-FRI 12-4 SAT
24 hour answer phone: 01-388 5721

● Circle No. 290

IBM SELECTRIC GOLFBALL PRINTERS

AND

INPUT, OUTPUT 735 TYPEWRITERS

PRINTERS FROM **£195.00**

735 TYPEWRITERS FROM **£245.00**

WIRING AND COMMISSION TO SUIT

ACULAB INTERFACE **£ 48.00**

ACULAB INTERFACES EX STOCK **£155.00**

ALSO AVAILABLE IBM 71, 72, 82 typewriters
Full workshop facilities for rebuilds and servicing.
Keyboard ASCID-ASCII, 10-12 pitch, language conversions undertaken.
11", 13", 15" platen lengths, split platens pin feed platens. Operational keylever repeats fitted on request.
Full IBM range of 10-12* pitch heads including language, symbol and metric.
Language keybuttons blue or grey.

WE BUY SELL OR EXCHANGE ALL IBM SELECTRIC TYPEWRITER MODELS

FOR FURTHER DETAILS PHONE **STUART KIRBY OR LOUIS BAKER**

KEYTRONICS

UNIT 3, EASTINGTON TRADING ESTATE
EASTINGTON, NR STONEHOUSE
GLOUCESTER

PRICES EXCL VAT @ 15%
& CARRIAGE & PACKING
CALLERS BY APPT ONLY PLEASE

● Circle No. 291

COMPUTECH for



COMPUTECH for



COMPUTECH SOFTWARE & HARDWARE IS WIDELY ACCLAIMED - WHY?

Companies like Shell UK Oil, Grindlays Bank, W.H. Smith, government departments and hundreds of firms from multinational corporations to sole traders and small businesses have licensed Computech software. Why?

Thirty years experience of business fifteen years experience of computing and dedication to serving the users' interests economically must be major contributions. By the time this advertisement appears about 1000 business software packages will have been installed and supported by us. Note other features which appeal to our customers - no special equipment, all configurations of Apple systems supported, no extra charge for lifetime support, hot-line service, economical use of hardware resources, program code supplied, modifications allowed, full validation, all accountancy requirements satisfied, all data written to disk and recoverable on demand, very simple operation, emulation of traditional manual methods, comprehensive manuals with sample reports, reliable operation, advisory bulletins and free fixing of bugs, (which is fortunately rare). Reduced licence fee for new versions with extra features. As approved dealers of Apple products and actual manufacturers of compatible hardware we combine the knowledge of hardware and software so essential for the application of microcomputers.

COMPUTECH SOFTWARE AND HARDWARE INCLUDES:

Payroll for 350 employees, 100 departments, all pay periods, printed payslips, approved year end documents, very quick and easy to use, **£375**. **Sales, Purchases and General Ledgers £295** each, detailed statements. **Job Costing and Group Consolidation** are amongst many and various applications of the **General Ledger** package, which supports values to totals of one thousand million accurate to a penny! Our **Utilities Disk** available like other packages in 13 sector or 16 sector format, is widely used for reliable, error checking, copying, including single drive, and the renowned **DPATCH** program beloved of programmers for **£20**. We have developed a **Terminal Utilities** package which enables Apple to Apple and Apple to mainframe communications with local processing and storage as well as Apple to host communications from the amazingly low price of **£130**. Our **Graphics Utilities** program for use with the **Microline** and **Epson** families of printers enable the plain paper production on low cost printers of high resolution screen pictures, graphs etc. - free with **Microlines** or **£30** separately. **Keyboard Driver** enables the use of our **Lower Case** adaptor with BASIC programs and **Applewriter Patches** supplied **FREE** with our character generator package (total cost **£50**) is separately available on disk with documents for **£10**. At the same price **CAI** (convert Apple pictures for ITT) makes binary high resolution picture files display properly on the ITT 2020. We sell the famous **Visicalc** for **£111** and have delivered systems using it to do amazing things like production control, shipping accounts and stocks and shares valuations! The versatile **Applewriter** word-processing package at only **£39** especially employed with our **Lower Case Character Generator** is widely used by people who cannot type to produce word-perfect copy! Experience with Apple systems has led to the design and manufacture of compatible products with enhanced features at very favourable prices to satisfy users' needs. These include the **Diplomat Serial Interface** which has handshaking capability and switchable options (**£80**), the **Diplomat Parallel Interface** which enables the direct use of text and graphics with the **Microline** and **Epson** printers and is a complete 'plug in and go' item with gold-plated edge-connector at **£80** and has optional direct connection for **Centronics 730/737** printers. Our new **Diplomat Communications Card** at **£95** is a sophisticated peripheral especially suitable for Apple to mainframe communications at high speeds in full duplex mode with switch selectable bit rates and other options. The **Lower Case** adaptor is available for Apples (revision 7 and earlier) as well as ITT 2020, complete with diskette software for **£50**. It offers true descenders on screen and the £ sign. We also have an **Optional Character Generator** for the ever popular **Microline M80** at **£15**. This provides £ sign and improved digits and lower case characters with USASCII special symbols. Our price for the **Microline M80**, with graphics, 40, 80 and 132 characters per line, friction, sprocket and teleprinter feed, is only **£295** amazing for this small, quiet reliable 'look alike' printer. Tractor option is **£40** and **Serial Adaptor £80**. The **Microline M82**, bidirectional printer with both parallel and serial input is only **£345**, it can have an optional 2K buffer, while the **Microline M83** full width adjustable tractor 120 cps printer with similar specification is only **£595**. Then for all computer users there is the unique **Micromux** which from **£800** provides up to 16 ports for simultaneous independent serial asynchronous communications! Telephone for data sheets or to arrange a demonstration or for the address of our nearest dealer. Please hurry - the demand for our products has been such that some have been temporarily out of stock. We offer the effective low cost solutions you need. **Prices exclude V.A.T., carriage and packing.**

COMPUTECH SYSTEMS

168, Finchley Road, London NW3 6HP. Tel: 01-794 0202

AGENTS THROUGHOUT THE UK AND OVERSEAS

Business Computer Centre

Businessmen!

A more efficient stock control

- faster invoicing
- instant Debtors list
- faster statements

means more profits with Business Computer Centre Package

- Printer
- Computer
- Software — one package under £5,500



Business Computer Centre 26 Eastcastle Street,
London, W1N 6PB (near Bourne's Oxford Street)

Fact! BCC offers unrivalled HELP to 1st time computer BUYERS

Fact! The BCC package is designed by businessmen for businessmen

Fact! BCC offers you a highly qualified staff to answer all your queries immediately — No cowboys.

Fact! BCC arranges a Service Contract to guarantee continuous computer output.

Fact! The BCC Software program is written in CIS COBOL the business language.

Fact! Leasing and HP arranged.

SUPERBRAIN: DQD	£2800
HD 5/4	£4250
PRINTER: DRE 8820	£1300
FLOWRITER	£1800
MEDIA: DYSAN 204/2D (Set of 10)	£45
SOFTWARE: WORDSTAR	£250
WORDSTAR MAIL-MERGE	£75
DATA STAR	£150
SUPERSORT I	£125
INCOMPLETE RECORDS	£750
D BASE II	£385
INTEGRATED A/C's PACKAGE	£1250

For discussion and demonstrations

Tel: (01) 580 4273



Now open
26 Eastcastle St
London, W1

● Circle No. 293

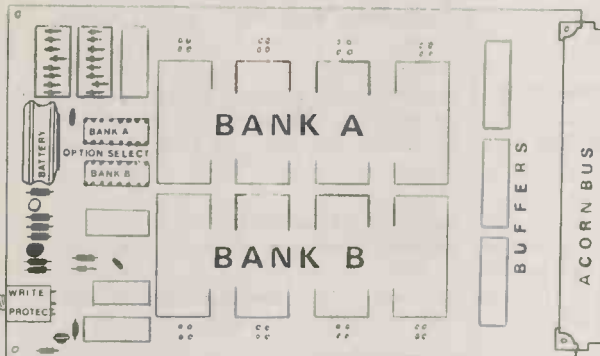

CU-MEM — UNIVERSAL MEMORY

Up to 64K of byte-wide standard memory
NMOS RAM, battery-backed CMOS RAM,
ROM, EPROM, EEPROM

CU-MEM has eight sockets arranged in two independent banks, each of which can be filled with 24 or 28 pin industry standard memory devices in 1K, 2K, 4K or 8K bytes sizes.

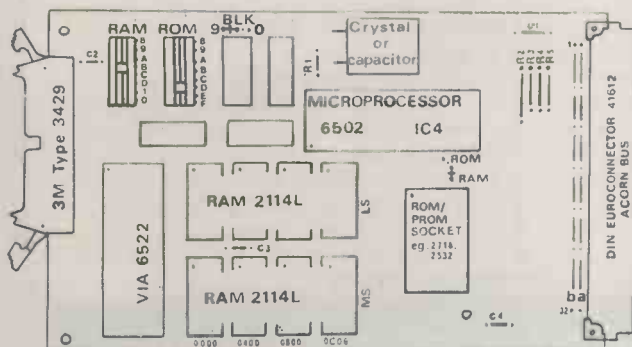

CUBIT — VERSATILITY PLUS

This Eurocard carries 4K RAM, 4K ROM/EPROM, a VIA 6522 i/o chip and a DIN connector to the Acorn Euro-bus. It can be used:-

- ★ as a 6502-based single board microcomputer
- ★ as an extension to AIM 65 and similar computers
- ★ as a peripheral to a CUBIT or other computer

CUBIT and CU-MEM are fully compatible with the Acorn range of Eurocards (eg. VDU, disk, analog)

Control Universal supply CUBIT, CU-MEM, and all Acorn and Rockwell products.

Control Universal Ltd, 11/15 Bush House,
Bush Fair, Harlow, Essex.
Tel: 0279 31604/412043.

● Circle No. 294

FLOPPY DISK DRIVES FOR TRS 80 AND VIDEO GENIE

DUAL DISK UNITS

2 x 40 TRACK DRIVES

£440

2 x 80 TRACK DRIVES

£569

SINGLE DISK UNITS

1 x 40 TRACK DRIVE

£236

1 x 80 TRACK DRIVE

£299

DISK DRIVE CABLES

2 DRIVE CABLE

£15.50

4 DRIVE CABLE

£26.00



PERCOM DATA SEPARATORS

£20

Plugs into the TRS 80 expansion interface and corrects 'READ/VERIFY' and 'CRC ERROR! TRACK LOCKED OUT!' problems on the inside tracks of any floppy disk system. Comes with full installation instructions — NO SOLDERING, NO CUTTING, JUST PLUGS INTO THE EXPANSION INTERFACE.

Call your nearest dealer for a demonstration:

RADIO SHACK LTD.,
188, Broadhurst Gardens,
London NW6
Tel: 01 624 7174

COMPSHOP LTD.,
14, Station Road,
New Barnet, Herts.
Tel: 01 441 2922

COMPSHOP LTD.,
311, Edgware Road,
London W2
Tel: 01 262 0387

COMPSHOP LTD.,
19, Herbert Street,
Dublin 2
Tel: 604 165

**LONDON COMPUTER
CENTRE**, 43, Grafton
Way, London W1.
Tel: 01 388 5721

N.I.C.,
61, Broad Lane,
London N15.
Tel: 01 808 0377

**CROYDON COMPUTER
CENTRE**, 29a, Brigstock
Road, Thornton Heath,
Surrey.
Tel: 01 689 1280

P J EQUIPMENT LTD.,
3, Bridge Street,
Guildford
Tel: 0483 504801

**R.D.S. ELECTRICAL
LTD.**, 157-161, Kingston
Road, Portsmouth
Tel: 0705 812478

**TANDY HASTINGS
LTD.**, 48, Queens Road,
Hastings.
Tel: 0424 431849

**MICROWARE
COMPUTING
SERVICES**, 57, Queen
Charlotte Street, Bristol
Tel: 0272 279560

**BLANDFORD
COMPUTERS**, Higher
Shaftsbury Road,
Blandford Forum
Tel: 0258 53737

TAPE SHOP
32, Viaduct Road,
Brighton.
Tel: 0273 609099
PARWEST LTD.,
18 St. Mary Street,
Chippenham.
Tel: 0249 2131

COMPUTER SHACK
14, Pittville Street,
Cheltenham.
Tel: 0242 584343

ENSIGN,
13-19, Millford Street,
Swindon, Wilts.
Tel: 0793 42615

**TANDY
GLOUCESTER**,
13, Clarence Street,
Gloucester
Tel: 0452 31323
COMSERVE,
98, Tavistock Street,
Bedford.
Tel: 0234 216749

**CLEARTONE
COMPUTERS**, Prince of
Wales Ind Estate,
Abercarn, Gwent.
Tel: 0495 244555

EMPRISE LTD.,
58, East Street,
Colchester.
Tel: 0206 865926

**MAGNUS MICRO-
COMPUTERS**,
139 The Moors,
Kidlington, Oxford.
Tel: 08676 6703

**CAMBRIDGE
COMPUTER STORE**,
1, Emmanuel Street,
Cambridge.
Tel: 0223 65334

I.C. ELECTRONICS,
Flagstones,
Stade Quarter,
Biddenden, Kent.
Tel: 0508 291816

MICRO CHIP SHOP,
190, Lord Street,
Fleetwood, Lancs.
Tel: 03917 795111
**HARDEN MICRO-
SYSTEMS**, 28-30, Back
Lord Street, Blackpool.
Tel: 0253 27590

**AMBASSADOR
BUSINESS COM-
PUTERS LTD.**,
Ashley Lane Works,
Shipley, W. Yorks
Tel: 0274 595941

Q-TEK SYSTEMS LTD.,
2 Daltry Close, Old
Town, Stevenage, Herts
Tel: 0438 65395

COMPUTER & CHIPS
Feddinch Mains House,
St. Andrews, Fife,
Scotland
Tel: 0334 72569

**NORTH WEST
COMPUTER
CONSULTANTS LTD.**,
214 Market Street,
Hyde, Cheshire
Tel: 061 366 8624

**HEWART MICRO-
ELECTRONICS**,
95, Blakelow Road,
Macclesfield,
Tel: 0625 22030

KARADAWN LTD.,
2 Forest Way,
Great Sankey,
Warrington.
Tel: 0925 572668

PHOTO-ELECTRICS,
459 London Road,
Sheffield.
Tel: 0742 53865

ARC ELECTRONICS,
54, Meron Drive, Sandal,
Nr. Wakefield,
W. Yorks WF2 6SL
Tel: 0924 253145

**VICTOR MORRIS
LTD.**, 340 Argyle
Street, Glasgow,
G2 8LY
Tel: 041 221 8958

THOMAS WRIGHT LTD.,
Thorite House,
Laisradyke,
Bradford,
Tel: 0274 663471

GNOMIC LTD.,
46, Middle Street,
Blackhall,
Hartlepool.
Tel: 0783 863871

**BRIERS COMPUTER
SERVICES**, 1, King
Edward Square,
Middlesbrough,
Cleveland.
Tel: 0642 242017

3 LINE COMPUTING,
36, Clough Road, Hull.
Tel: 0482 445496

**H.C. COMPUTER
SALES LTD.**, 182,
Earloway, Team Valley
Trading Estate,
Gateshead.
Tel: 0632 874811

EWL COMPUTERS LTD.,
8, Royal Crescent,
Glasgow.
Tel: 041 332 7642

CUMANA LTD

35 Walnut Tree Close, Guildford, Surrey, GU1 4UN.
Telephone: (0483) 503121.

Please add VAT to all prices.

Delivery at cost will be advised
at time of order.

● Circle No. 295

SPOCK: "Computer! Calculate the value of Pi to ten thousand decimal places".
COMPUTER: "Working . . ."

CAN YOUR COMPUTER SPEAK?

The **WIDEBAND SPEAKEASY** speech synthesiser adds voice response to any computer with a parallel port including **PET, APPLE, expanded ATOM, HORIZON** etc.

for Only **£69 + VAT**

- * UNLIMITED VOCABULARY
- * EASY TO PROGRAM
- * LOW MEMORY OVERHEAD
- * COMPLETE MANUAL WITH DICTIONARY, SAMPLE SOFTWARE AND TUTORIAL ON SPEECH PRODUCTION.

Also includes high flux speaker and power supply, all housed in high quality wood cabinet, with volume control and rear pitch control.

Programmed with simple phonetic codes. Apart from the obvious applications of voice response in manufacturing, testing, blind terminals etc., this product also teaches a great deal about linguistics and speech production.

Software is available in BASIC and Z-80 and 6502 assembly for direct input in PHONETIC SPELLING closely related to the ARPABET international phonetic alphabet.

For your nearest dealer contact:

WIDEBAND PRODUCTS, CAMBRIDGE RD., ORWELL, ROYSTON, HERTS.

A subsidiary of Sands-Whiteley Research and Development

TEL: 0223 208017



● Circle No. 296

WHAT'S YOUR NUMBER?

Whether your PET/CBM is in the 2000, 3000, 4000 or 8000 series it can be upgraded with one or more of our plug-in chips. For example, SUPERCHIP adds auto-repeat, single key Basic, and loads of 8032 facilities to any of the 40 column models; MIKRO is a powerful assembler which makes writing machine code as easy as writing Basic; FASTER BASIC speeds up virtually any Basic program, sometimes by 100% or more and ARROW allows you to load and save programs at around 7 times normal speed using ordinary tapes on the Commodore cassette deck.

High resolution graphics are not a standard PET feature, but the SUPERSOFT HR-40 HIGH RESOLUTION GRAPHICS BOARD is a very modestly priced and easy to fit extension. It fits internally without soldering, and allows every dot on the screen to be individually addressed, giving 320 by 200 resolution. The HR-80 board for the 8000 series will be available in time for Christmas.

Word processing in an ideal application for the PET with its large clear screen and well laid out keyboard. The PAPERMATE word processor is extremely powerful and provides a low-cost solution for disk and tape users alike, but if you can afford the best then MICROSCRIPT is the answer. Because MICROSCRIPT is in ROM 30,000 bytes are available for text storage — that's three times as much as with other programs!

PLUG-IN CHIPS

SUPERCHIP	£45
MIKRO ASSEMBLER	£50
FASTER BASIC	£30
ARROW	£30
PIC-CHIP	£45
TOOLKIT (2/3000)	£29
TOOLKIT (4/8000)	£34

HIGH RESOLUTION BOARDS

HR-40/HR-40B	£149
HR-80	Enquire
Utility software in EPROM is included.	
Additional software packages are available (phone for list)	

SOFTWARE

MULTISORT	£25
PAPERMATE	£35
DISK MERGE	£15
HITCH-HIKER	£16
HALLS OF DEATH	£14
ASTEROIDS	£8
GIDDY GHOULS	£8

WRITE OR PHONE FOR OUR FREE CATALOGUE OF PET SOFTWARE & ACCESSORIES

SUPERSOFT

First Floor, 10-14 Canning Road, Wealdstone,
Harrow, Middlesex, HA3 7SJ, England
Telephone: 01-861 1166

● Circle No. 297

Thinking of computerisation-

8 days a week?

Sometimes it must feel exactly that – having to deal with a seemingly unending stream of information in your books, yet still feeling a little apprehensive about computerisation and all its confusing terminology.

If you are a small to medium size company why not contact us and arrange a demonstration, or even come to one of our 'Open Evenings'.

We are computer specialists – with a difference. We don't believe in blinding people with science, we'll actually sit down and explain all the jargon to you. You'll be able to see for yourself how simple it is to use one of our programmes by having a go on one of our machines, in no time at all you'll discover how flexible our systems really are.

Our programmes are suitable for most Business Computer Systems – in fact we are not bound to any one manufacturer. All the good computer suppliers know about us and many of them mention us in their ads so you'll be in good hands.

Contact Philippa Toone on 01-727 5561 – she'll be delighted to hear from you.

**GRAFFCOM
SYSTEMS GROUP**

102 Portland Road Holland Park London W11 4LX

● Circle No. 298

FAR INTO THE FUTURE

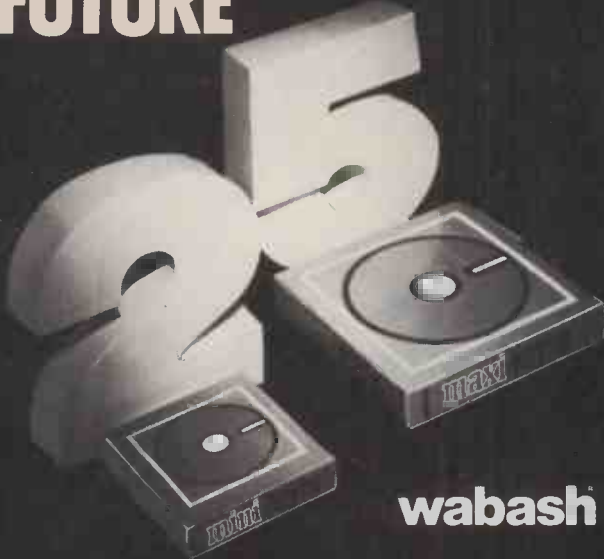

Only Wabash guarantees its diskettes well into the future. Five years for Maxi-Myte 8" Diskettes, and two years for Mini-Myte 5¼" Diskettes. You can trust your data with Wabash for years to come.

Write or phone for a free brochure and immediate prices.

BRAXAS MEDIA SUPPLIES
357 EUSTON ROAD, LONDON NW1 3AL. TEL: 01-388 2061

● Circle No. 299

BEAT OUR PRICES!

2114 (250 ns) £1.07p

4116 („ „) 69p

74, 74LS and CMOS series at excellent prices. All orders above £25 — 10% discount. Please add 25p Postage and VAT. For price list only send 22p + SAE.

All orders sent same day.

NASCOM's main agent for Scotland. We stock HS-IN fast tape system as featured in "Making Tracks" — PCW May '81. Send SAE for details.

All devices are full spec and fully guaranteed.

MICRO-SPARES

ACCESS 19 ROSEBURN TERRACE VISA
EDINBURGH EH12 5NG

TEL: 031-337 5611

● Circle No. 300

THE REVOLUTIONARY TWOSOME

SDM Computer Services are major distributors of the Intertec Superbrain micro computer. This machine has established itself as *the* micro for the serious business user... it is not an upgraded hobby system.

Running, as it does, under the CP/M operating system, there is a wealth of readily available commercial software and SDM have their own tried and tested suite of packages covering:

Invoicing ● Stock ● Sales ledger ●
Purchase & Nominal ledgers ● Payroll

All models are available from double density through the 1.5MB system to the (shortly to be announced) Superbrain W6 which includes a 5MB Winchester.

Full software and engineering support when you buy from SDM.

MPI-88G — everything you need

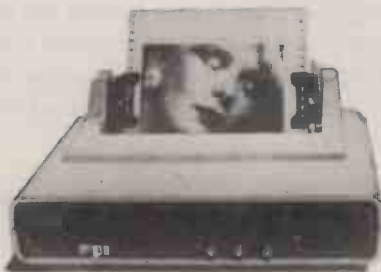

SUPERBRAIN — built for commerce

This printer has more standard facilities than any other at a similar price:

- RS232 serial and Centronics type parallel,
- 1K byte buffer
- Upper and lower case 96 character ASCII set,
- 100 cps maximum
- 10, 12, 16.5 cpl and correspondence font
- High resolution graphics (vertical 72 dots/inch, horizontal 82 dots/inch)
- 6 or 8 lines per inch paper feed
- Full forms control

All the above list and others are *standard* at no additional cost.

Whether it is for your Superbrain business system or any other computer with RS232 or Centronics interfaces you cannot find a better printer.

Supplied ex stock for the amazing price of £399 plus VAT and P & P.

S.D.M. COMPUTER SERVICES

BROADWAY, BEBINGTON, WIRRAL,
MERSEYSIDE L63 5ND. Tel: 051-608 9366



● Circle No. 301

Pete & Pam Computers



APPLE SYSTEM SALES AND SERVICE
IN BOTH LONDON AND LANCASHIRE

Competitive Quotes and Personal Service

Ring Chris Gillard in London — Pete or Pam Fisher in Lancashire

Now over 500 items for APPLE in stock

CHRISTMAS GAME SPECIAL

Buy any five games — DEDUCT 10% off the total price

Full catalogue and description are available



Apple Galaxian — Galaxy Wars — Head-On — Galactic Revolution — Galactic Trader — Galactic Empire — Mystery House — Bridge Partner — Cheater King — Gammon Gambler — Roulette — Cops — Apple 21 — Puckman — Global War — Space Warrior — Apple Typhoon — Sneakers — Galactic Attack — Gorgon by Nasir **All at £12.95**

Microsoft Adventure — ABM — Dog Flight — Phantoms Five — Orbiter — Pulsar — Microchess 2 — Odyssey — LA Land Monopoly — Morloc's Tower — Rescue at Rigel — Space Eggs — Trilogy of Games — The Prisoner — Raster Blaster — Autobahn — Space Raiders — Tawala's Last Redoubt — Gamma Goblins — Apple Panic — Cops and Robbers **All at £14.95**

Computer Conflict — Computer Quarterback — Carrels and Cutthroats — Space Album — Bill Budge 3D Graphics Tutor — Cyber Strike — 3 Mile Island — Adventure 789 — Hi Res Soccer — Temples of Apshar — Hellfire Warrior — Zork — Computer Baseball — President Elect — The Battle of Shiloh — Tigers in the Snow — Warp Factor — Computer Conflict **All at £20.95**

Computer Air Combat — Computer Ambush — Computer Bismark — Operation Apocalypse — Torpedo Fire — Shattered Alliance **All at £20.95**

OLYMPIC DECATHLON from Microsoft
Superb Hi-Res Graphics — Winner of this year's WCCF prize for creative programming **£12.95**

FLIGHT SIMULATOR by Sub-Logic
So realistic — you might feel aiseek! — be warned **Disk £19.95**
Cassette £14.95

DRAGON FIRE from Dablin Corp. **£29.95**

VERSA EXPANDER PORT
An expansion cable ZIP socket for the Apple game I/O socket allows zero insertion force of peripherals requiring connection to game socket **£12.95**

SENSIBLE SOFTWARE UTILITIES
Applesoft Programs Optimiser **£12.95**

Multi Disk III **£14.95**

Super Disk Copy III **£17.95**

DOS Plus **£17.95**

Disk Organizer II **£17.95**

Disk Recovery **£17.95**

Applesoft Plus Structured Basic **£14.95**

DAKIB 5 PROG AIDS 3.3 **£49.00**

PASCAL SHOOTER **£79.00**

If you want to learn Pascal this is the package to use — complete with two disks

PASCAL PROGRAMMER **£79.00**

The Pascal programmer's dream — all the utilities you wanted to use but never had time to write

RAMCARD **£99.95**

A 16k Expansion card for you Apple. It will provide additional memory for Visicalc load Integer from a System Master and is fully compatible with Apple's Pascal System. The only board with Neon Read/Write indicators. The only card with data bus lines for faster data retrieval.

RAMBEE 16 **£89.95**

UK entrant to the expansion card market — does not need to be ribboned to the memory area

MEMORY MANAGEMENT SYSTEM **£29.00**

A utility that moves DOS onto a 16k expansion card — freeing motherboard Ram space for larger programs

Z80 SOFTCARD **£195.00**

A Z-80 microprocessor for Apple comes with CP/M operating system and Microsoft Basic 5

COBOL 80 **£299.00**

FORTRAN 80 **£109.95**

BASIC COMPILER **£199.00**

ASSEMBLY LANGUAGE DEVELOPMENT (6502, 8080 and Z80) **£79.00**

Z TERM **£59.00**

Software that allows you to emulate the terminal of your choice whilst using Apple with a Z-80 Softcard

80 COLUMN BOARDS **£195.00**

SUP-R-TERMINAL **£185.00**

VIDEO **£169.00**

NEC GREEN SCREEN MONITOR **£169.00**

WORDSTAR for APPLE **£169.00**

If you want the best in word processing for Apple then WORDSTAR is the answer. Very well documented and great to use. Requires the installation of a Z-80 Softcard

MAILMERGE **£69.00**

Allows you to maintain name and address lists and merge fields into text to form letters etc

SOFTKEY **£74.00**

(Basic or pascal versions available) A 15 key programmable keypad

Patch for WORDSTAR and SOFTKEY to permit use of programmable pad with WORDSTAR **£39.00**

ABT NUMERICAL KEYPAD **£74.95**

VISCALC 3.3 **Our Price £105.00**

At last — Visicalc on 16 sector DOS 3.3 with 12 additional commands. Enhanced Manual is included

VISIDEL **£105.00**

New from Personal Softcard — type in whatever key words, phrase dates or numbers you want the info to be associated with and store away

VISITERM **£79.00**

Allows your computer to communicate with larger computers or other personal computers. Link your personal computer with your company's mainframe

VISIPILOT **£85.00**

Automatically creates high resolution graphs and charts. Visualise data in six different formats and 6 different colours. Data can be directly entered or data files loaded from VISCALC 3.3

VISITREND **£129.00**

Allows you to perform sophisticated math operations on a time series data such as stock prices or production figures. Includes multi-line regress cumulative intal percent change lead/lag moving averages, smoothing and various transformations which let you create new time series. This package also includes VISIPILOT

VISIFILE **£139.00**

New data base from Personal Software

DB MASTER **£129.95**

The data base with 100 fields operating on multi-diskette files for large capacity

DB MASTER Utility Pack No. 1 **£60.00**

Links DB Master with Apple text files and VISCALC 3.3 add delete or change existing DB Master fields and more

DB MASTER for Corvus — available soon **£295.00**

INFORMATION MASTER — Data Base **£79.00**

A dream to use has advanced facilities such as global change and calculator mode of entering figures. A system that a novice can use with ease

DATA MASTER **£55.00**

A utility for use with INFORMATION MASTER allows the splitting of a data base system. selectivity change of field types and transfer of print formats

TRANSIT **£29.00**

A utility that enables you to link INFORMATION MASTER to many files including those created by VISCALC

REMOTE OPERATING SYSTEM — ROS

Provides multiple Apple II users with the capability of utilising the disk storage available from one control Apple. Up to 127 remote computers may be connected to one central Apple containing up to 8 floppy disk drives starter system (1 central + 2 remote boards) with software and cables.

£499.00

Single remote board **£124.00**

64K RAM CARDS

Here at last! Can be used in pairs to emulate a disk drive.

2 cards and card emulating software. **£449.00**

Single board **£225.00**

TASC — THE APPLESOFT COMPILER

A two pass compiler from Microsoft — the Applesoft authors. Comes with extensive documentation and copyable disk. Compiles to disk so can compile any length of programme. From 2 to 20 times improvement in speed. **£109.00**

THE MILL — A 6809 plug-in board for Apple

Can run at full speed whilst the 6502 runs at 20%. Comes with either a Pascal speed-up kit to increase the speed of execution of Apple's U65D Pascal or a 6809 assembler. Also available a debugging utility.

COMING SOON — OS9 Operating system. **£249.95**

PASCAL JOB CONTROL SYSTEM — from High Technology **£295.00**
A last sophisticated job control/costing system able to control costs on 400 jobs, providing useful reports and maintaining 50 cost centres with 500 sub cost centres. Worth its weight in gold!

APPLE HOW TO **£29.95**

Requires Int Basic or 16K Expansion Card — teaches calculating and programming

APPLE MUSIC THEORY **£29.95**

ELEMENTARY MY DEAR APPLE **£19.95**

Tuition for Children

ECHO II SPEECH SYNTHESIZER **£139.95**

Based on TM5 5200 chip from TI — type in speech direct from keyboard

EXPANSION CHASSIS **£399.00**

Long awaited — here at last — More slots for your Apple

MOUNTAIN CPS — Multi-function Card **£135.00**

A bi-directional serial interface — parallel port and clock/calendar card — all on one board. Can be made to use phantom slots

VISIWRIER **£149.95**

Superb graphics tablet from Versa Computing — you don't have to go to the expense of an Apple Graphics Tablet for graphics capability

VERSA EXPANSION SOFTWARE **£20.95**

Auxiliary pack for the VISIWRIER includes the ability to draw in fine detail using magnification mode

EPSON MX-80 P/T **£398.00**

9 x 9 matrix printer with friction and tractor feed

EPSON MX-80 T **£349.00**

Tractor feed only

INTERFACE AND CABLE **£65.00**

For the above (non-graphic)

GRAPPLER from Orange Micro **£99.00**

An interface for the Epson MX-80 and 100 that obeys Apple protocols and has a graphics dump programme in ROM producing 2 sizes of picture and 360 degrees rotation with positive or negative image

AIO INTERFACE from 55M **£119.95**

MACHINE COVERS — only the best material used

Apple only **£5.95**

Single Disk **£2.95**

2 stacked disks **£4.45**

Apple, 2 disks and 9" monitor or Apple and 12" monitor **£8.95**

Apple and 2 disk **£7.95**

Epson MX 70/80 **£5.45**

Paper Tiger 445 — 460 **£5.45**

BASF DISKS (for 10) **£18.50**

Authorised Apple Sales and Service

LONDON RETAIL 98 Moysers Road London SW16 6SH
Tel 01 677 2052/7341

MAIL ORDER AND DISTRIBUTION, Waingate Lodge Waingate Close
Rossendale Lancs BB4 750
Tel Rossendale (0706) 227011



Prices do not include VAT. Please add 15% VAT to your remittance. Postage and packing FREE

● Circle No. 302

NEW 64K RAMCARD FOR THE APPLE

for little more than you could pay for the old 16K RAMCARD. It will replace the 16K card as a LANGUAGE CARD. Uses bank selection similar to 16K card. Each Apple can power up to 3 of these 64K cards plus 1 16K card giving an

**INCREDIBLE 1/4 MEGABYTES OF RAM
64K CARDS ONLY £189 each**

16K RAMCARDS available at the much reduced price of £69.

Other Apple cards available.

EPROM PROGRAMMER £58
Programs 5V EPROMS including the 2716, 2732 and the new 2764 64k-bit EPROM.

EPROM EXPANSION CARD £39
Holds six 5 volt 2716's or 2516's (not included) for a total of 12K bytes of read only memory.

SPEECH SYNTHESISER £179
Uses Votrax SC-01 chip to give UNLIMITED VOCABULARY. Requires 10 bytes/sec for continuous speech. Demonstration software on disc.

VIA BOARD £38
Adds two 8-bit input/output ports, a serial port and 2 timers to your Apple.

CLOCK SOFTWARE £7 on tape/£8 on disc
Together with the VIA BOARD will provide your Apple with a real-time clock.

SINGLE CHANNEL ADC £29
140 micro-second conversion time 8-bit ADC. Provides full 8-bit resolution between two levels within 0-+5V range.

16 CHANNEL ADC £49
Less than 100 micro-second conversion time 8-bit ADC.

SINGLE CHANNEL DAC £28
8-bit adjustable 0-+10V full scale buffered voltage output DAC (settling time 500 nano-seconds).

PET ADC's and DAC's

SINGLE CHANNEL ADC £38
140 micro-second conversion time 8-bit ADC. Provides full 8-bit resolution between any two levels within 0-+5V range.

SINGLE CHANNEL DAC £36
8-bit adjustable 0-+10V full scale buffered voltage output DAC (settling time 500 nano-seconds).

All prices inclusive of VAT and postage and packing.
Cheques or official orders to:

MERTON ELECTRONICS

Dept PC, 8 Rutlish Road, Wimbledon, London SW19
Tel: 01-543 3533

● Circle No. 303

APPLE Hardware

APPLE 48K	625.00	APPLE 64K	710.00
Disk Drive with CTRL	360.00	Disk Drive w/o CTRL	275.00
Graphics Tablet	405.00	APPLETEL	560.00

Interface Cards

CCS RS232	95.00	CCS Parallel	79.00
CCS Centronics	79.00	CCS IEEE	155.00
Aristocard RS232	69.00	Aristocard Parallel	65.00
80 Column Card	175.00	Z-80 Softcard	175.00
16K RAM Card	95.00	Sup-R-Terminal	190.00
Eurocolor Card	95.00	CPS Multifunction	135.00

Software and Consumables

VISICALC 3.3	98.00	VISITERM	78.00
DESK TOP PLAN II	98.00	VISIDEX	98.00
VISIPILOT	89.00	DB MASTER	119.00
WORDSTAR ver 3.0	144.00	MAILMERGE	59.00
5" Floppy Disks for 10	17.50	Paper 11" x 9.5" (2000)	12.00

Printers

Olympia KSR ESW 100	975.00	Epson MX100	560.00
Epson MX80 F/T	389.00	Epson MX82	379.00
Anadex 9500	895.00	Anadex 9501	985.00
Centronics 737	375.00	445 Paper Tiger	469.00

Video Monitors

12" Green Monitor	165.00	PORTATEL 14" Colour	310.00
-------------------	--------	---------------------	--------

SYSTEMATICS

Integrated Accounting Package

Sales Ledger	250.00	Purchase Ledger	250.00
General Ledger	250.00	Stock Control	250.00
Invoicing	250.00	Payroll	250.00

Postage and Packing on APPLE & Printers £5.00
Other Goods £1.00

ALL PRICES ARE EXCLUSIVE OF VAT

GRANATA COMPUTER SYSTEMS

CENTURY HOUSE, HAVELOCK ROAD,
SOUTHALL, MIDDLESEX.

TEL: 01-843 1971.

● Circle No. 304



TESTED & ASSEMBLED PCB'S & KITS

6 MONTH GUARANTEE — REPAIR SERVICE

I-8080 S-100 ENCLOSURE SHEET METAL KIT

Just like THE ORIGINAL IMSAI: Mainframe with blue cover, cardguides and hardware spaced for PS-28D Power Supply, up to 22 slot motherboard.

Kit of all metal parts and hardware with documentation. £120.00

Thinker Toys Wunder Buss 20 for above w/o conn. £85.00

S-100 Connectors—each. £3.60

8015 Blank jump-start panel w/3 switches. £41.00

8035 Jump start panel for 2 SA-400. £95.00

PS-28D POWER SUPPLY PARTS KIT

Mounts in the I-8080 enclosure, supplies + 8V @ 28A, +1- 16V @ 3A, kit includes board, transformer, documentation, and all components. Improved from original.

Kit. £180.00

PIO 4.4

4 parallel inputs and outputs (8212). £160.00

SIO 2-2

2 serial I/O ports, good to 9600 baud. £160.00

VIO-F

Improved memory mapped video I/O board, includes keyboard port. 256 character EPROM's, firmware, monitor.

Assembled & Tested. £269.00

DIO/CD

2 board disk controller for 8" or 5 1/4". £299.00

CPM 2.2

For DIO including documentation. £125.00

CPA

Improved Imsai style front panel works with Z80, etc. £249.00

MPU-A

8080 processor board—requires CPA. £129.00

MPU-B

8085 3MHz processor SBC w/serial plus parallel port, monitor. £249.00

RAM III 64K MEMORY

64K byte dynamic RAM board—Utilizes the Intel 3242 refresh controller and a single delay line for totally internal refresh. Uses time proven 4116 RAMS. memory mapped I/O boards are allowed to coexist by the use of phantom. Board select via A16 thru A20 extended address lines.

Assembled & Tested. £349.00

IKB-1

Intelligent keyboard uses 8035. £189.00

MDX

Dual SA400 drive enclosure. £78.00

DE 8

Dual 800R/801R horizontal style enclosure w/power supply and fan. £270.00

VIO-X

New port mapped video I/O board w/8085 processor, 8275 CRT controller, keyboard port, firmware.

Assembled & Tested. £249.00

IEEE 488 + 3P

New IEEE-488 I/O interface with 3 parallel ports. £599.00

Assembled & Tested. £599.00



FULCRUM SYSTEMS THE COMPLETE ANSWER



The 8025 Business System gives you:

- ★ 2.4 Mb Storage
- ★ 64k RAM
- ★ 2 x 8" Disk Drives
- ★ Choice of Terminal or Monitor
- ★ CPM 2.2
- ★ Complete range of Software offered
- ★ In House programming available

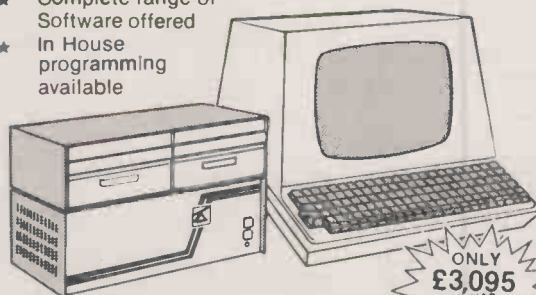

ONLY
£3,095
+ VAT
OFFER ENDS
31st DEC '81

A FULL RANGE OF FULCRUM
SYSTEMS AVAILABLE TO MEET
YOUR NEEDS!

ALL PRICES PLUS VAT

RING NOW



0621 828763

FOR FREE PRODUCT
BROCHURE AND DETAILS
OF OUR SUPPORT SERVICES
& DEALERS

Telex: 995411

Export enquiries welcome

● Circle No. 305

WHENEVER YOU HEAR
THE WORDS
Marksman & Apple

YOU PROBABLY THINK OF
WILLIAM TELL . . .

. . . BUT FROM TODAY
YOU WILL THINK OF

MDOS.

The operating system which allows
you to connect six 48k Apple II's to
a 20, 40 or 80 Mb Century Data
Marksman drive and obtain the
fastest index sequential random
access ever seen on an Apple
network at a price you can afford.

ENQUIRIES WELCOME

For full details contact:

**CHANNEL ISLAND
COMPUTER CONSULTANTS LIMITED**

Grove House, The Bordage, St. Peter Port, Guernsey, C.I. Telephone 0481 20155.

U.K. Offices opening next month.

● Circle No. 306

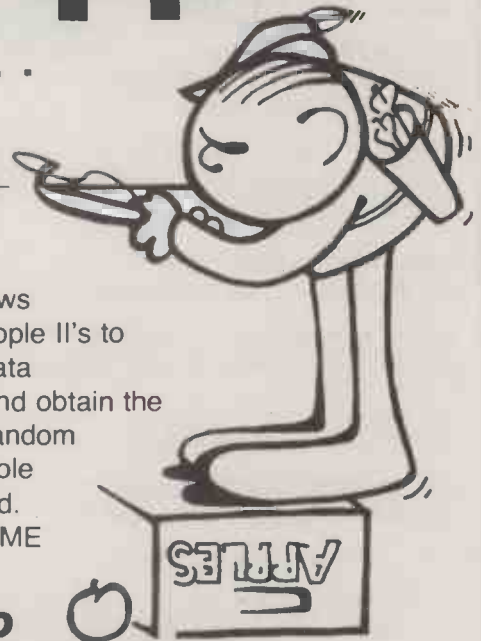

ADS1981Q173

THREE ACES FOR THE DEALERS

A
**Insurance
Brokers
Accounting
System**
RRP £1,500

A

A
**Recruitment
Agency
System**
RRP £350

A

A
**Advertisers
Accounting
System**
RRP £1,500

A

This DEAL beats all others HANDS down

We give up to 45% discount on the above systems to our registered DEALERS

Demonstration systems available on request

We can guarantee you will find no JOKERS in this PACKAGE



For further details contact Paul or
Dave on Stafford (0785) 42611 or
return the reply slip

92 Wolverhampton Road, Stafford, Staffordshire ST17 4AH
CORE INTERNATIONAL LIMITED
Company
Contact
Address

● Circle No. 307

THE COMPUTER COMPANY

CROYDON 01-654 4147

SHARP SYSTEMS

MZ80K 48K **£339**

MZ80K 48K **£1,399**

BUSINESS SYSTEM
DISCS, PRINTER, J10 UNIT
& ALL CONNECTIONS

MZ80B RRP **£1,095**
POCKET COMPUTER **£75**
ACORN ATOM **£120**



PHONE FOR
LATEST PRICES
ON ALL ITEMS

CPIM FOR MZ80B **£66**
WORDSTAR £269 MAILMERGE **£82**

Spellstar, Datastar, Supersort I, Supersort II, Wordmaster PL/1-80, BT-80, Mac, Sid, 2 Sid, Tex, Despool, CIs Cobol, Forms 2, Basic-80, Fortran-80, Cobol-80, M/Sort, Mu-Math, Mu-Lisp, Edit-80, Macro-80, Sales ledger, Client billing, Purchase ledger, Nominal ledger, Stock control.

COMPUTER AIDED INSTRUCTION **£48**

PETCAI FOR COMMODORE PET
AVAILABLE SOON ON SHARP

Please add VAT to all items and note

WE OFFER VALUE FOR MONEY &
WILL BEAT ANY ADVERTISED PRICE

Barclaycard, Access, delivery anywhere

78 LOWER ADDISCOMBE RD, CROYDON. TEL: 01-654 4147

● Circle No. 308

COMPUTER SUPPLIES FOR MINI AND MICROCOMPUTERS

We can supply the great majority of microcomputer related products at really competitive prices.

DISKETTES Nashua, Verbatim, Basf.

5¼" DSDD (packs of 10) from **£19.62**

5¼" SSSD (packs of 10) from **£17.09**

5¼" DSSD (packs of 10) from **£17.09**

RIBBONS Low and High Speed Printers

QUME Multi-strike Film Ribbon from **£2.30** each
All ribbons available in singles or in 12s

LISTING PAPER

Plain 11" X 9½" 1 part 60 gsm 1,000 sheets ... **£8.32**
(Other sizes and paper quality available)

BLANK CASSETTES

C10/C12 from **38p** each

LIBRARY STORAGE CASES

5¼" 10 Disk capacity from **£1.96** each

Postage and packing from **£1.50** V.A.T. not included

- We sell Apple, Commodore, VIC 20, ACT, HP, Computers.
- 24 hr Service Contracts.
- ACCESS & VISA WELCOME.

BEST DISCOUNT PRICES

33/35 Portugal Rd. (Dept.PC), Woking, Surrey. GU21 5JE
Tel: Woking (04862) 21776

DATALECT

COMPUTERS

● Circle No. 309

SUPERBRAIN



- 350K — 700K — 1.5MB — 6MB
- Twin Z80A's with 64K RAM
- 12" screen — 25 x 80 characters per line
- CP/M Basic, Cobol, Fortran etc
- Wordstar — Datastar — Mailmerge
- Int. Sales, Purchase, Nominal, Stock etc
- Stock control
- DBase 11 — relational database

SUPERBRAIN ENHANCEMENTS

- Up to 20% overall improvement on speed can be obtained using our special routines
- Dump screen facility
- Ability to implement despool
- Wordstar patches for fast, smooth screen operations & type while printing implemented
- Datastar patches — the bugs removed — improved screen and file handling



PRINTERS

- Diablo 630
- Tec Starwriter
- Nec Spinwriter
- DRE 1226
- Epson range
- Oki range

from **£350**
ex-demo ANACOM **£575***

TeleVideo® Systems

The Multi-User Family with
the MmmOST Security ...



- A family of multi-user systems —Z80A— CP/M — Starting from **£2,125** — 1 meg. floppy — 10 meg. Winchester (floppy back up) — 23 meg. Winchester cartridge tape back up — up to 16 users per disk system which may be networked — will run your existing CP/M software, eg. Wordstar, Integrated Accounts etc. — languages BASIC, COBOL, FORTRAN etc.



ACORN ATOM*

Also available
with built
in floppy
disk drive

£120



ATOM KIT 8K ROM 2K RAM	£120
ASSEMBLED	£150
KIT 12K ROM 12K RAM	£220
ASSEMBLED	£250
1K RAM SETS	£5.00
4K FLOATING POINT ROM	£20
(including 12K version)	
PRINTER DRIVE	£9
LS 244 BUFFER	£2.50
COLOUR ENCODER	£19
MAINS PSU	£8

*Available at Bristol only.

DAY 1 on-site maintenance contracts available.
FULL SOFTWARE SUPPORT & TRAINING

THE EBS GROUP
BRISTOL (0272) 428165



ELECTRONIC INFORMATION SYSTEMS
(BRISTOL) LTD.,
91 ASHLEY DOWN ROAD,
BRISTOL BS7 9JT

LONDON 01-471 4884
Easibee Computing
133-135 High Street North
London E6 1HZ

ALL PRICES EXCLUDE VAT AT 15% & DELIVERY

● Circle No. 310

PLAY YOUR CARDS RIGHT

AND CHOOSE  apple®



IT'S IN YOUR OWN HANDS

Pascal system £230.13
 Music system £308.44
 Versawriter £130.38
 Mill with Pascal £238.88
 Disc Controller £92.75
 3" disc drive £272.13
 NEC 12" green VDU £172.00
 Anadex 9500 £870.63

★ SPECIALS ★

Ricoh 1600S £1450.00
 Epson MX80 F/T £392.44
 Seikosha GP80 £242.81
 Centronics 737 £371.00
 DB Master £116.81
 Visicalc 3.3 £131.25

Visidex £116.81
 Visiplot £90.56
 Information Master £74.81
 Apple Plot £33.25
 Pascal Ledgers £250.00
 Ulasak Ledgers £250.00

Autobahn £12.99
 Apple Panic £16.41
 The Prisoner £17.09
 Cyber Strike £16.41
 Gamma Goblin £14.37
 Orbitron £15.68
 Gorgon £14.37
 Phantoms Five £15.68
 Pulsar II £15.68

RING FOR CATALOGUE

APPLE ACCREDITED LEVEL 1 SERVICE DEALER/CORVUS LEVEL 1 SERVICE DEALER

Professional Data Systems.

CARNE HOUSE, MARKLAND HILL, CHORLEY NEW RD, BOLTON.

ALL PRICES CORRECT AT THE TIME OF GOING TO PRESS
 (ALL PRICES SUBJECT TO VAT + POSTAGE & PACKING)



0204
493816



Micro General

MATRIX PRINTERS...

Please contact us for advice on printer selection

MICROLINE 80

Popular, robust printer with block graphics. New models 82A & 83A now available, 120 cps, true descenders, Serial/Parallel interfaces, switch selectable.



£259+VAT



EPSON MX-SERIES

Remarkably versatile printers for many applications. Graphics models and full range of interfaces available.

FROM **£359+VAT**
(FOR MX-80T)

CENTRONICS 739-2

Superb proportional print quality. Pln addressable graphics. Superscripts and subscripts. Forward and reverse paper motion.



£504+VAT

FREE DELIVERY to UK Mainland.

Listing paper £17.00+ VAT per 2,000 sheets.

FREE INSTALLATION within 30 miles of Reading.

DAY or EVENING appointments welcome.

MICRO GENERAL, 6 The Birchwoods, Tilehurst,
Reading, Berks RG3 5UH. Tel: 0734 25226.

● Circle No. 312

PD4 digital XY plotter



Standard specification includes:-

- IEEE-488 AH1, L1, E1 Interface
- Full A4 format ● 700 mm/s max. writing speed
- Suitable for direct connection to PET and any other computer
- Optional software including character generator available

Price including IEEE Interface **£596 + VAT**



J.J. LLOYD INSTRUMENTS LTD.
Brook Avenue, Warsash, Southampton, SO3 6HP.
England. Tel: Locks Heath 4221 (STD 048 95).
Telex: 477042 - JAY JAY - SOTON.

● Circle No. 313

- A.C.E. — A program line editor with macro facilities. £19.95 A48K
 Alien Rain (Galaxian) — Colour + hi-res version of pub game. £13.95 M48K
 Alien Typhoon — A much more difficult version of Alien Rain. £13.95 M48K
 Akalabeth — An advanced fantasy role playing game. £22.95 M48K
 Apple Doc — Cross reference utility + Variable Replacement. £22.95 A48K
 Apple Panic — Chase little apples up and down ladders. £16.95 M48K
 AppleWorld — Allows you to produce 3-D animated graphics. £38.95 M48K
 Ascii Express II — A complete intelligent terminal package. £42.95 A48K
 Asteron — The ultimate Asteroids replica game. £19.95 M48K
 Autobahn — Road race game with sound and hi-res graphics. £14.95 M48K
 Beneath Apple DOS — The definitive guide to the Apple DOS. £11.95 Book
 Both Barrels — 2 hi-res action games on one disk. £12.95 A48K
 Carrels and Cutthroats — Business simulation for 1 to 6 players. £23.95 A48K
 Computer Air Combat — Simulation of World War II air battles. £35.95 A48K
 CPS Multifunction Card — Serial, Parallel and Clock on one card. £183.95 Card
 Cranston Manor — A new hi-res adventure like Wizard & the Princess. £19.95 M48K
 Cross-Ref — Cross reference Applesoft programmers utility. £14.95 A32K
 Cyber Strike — 3-D hi-res action adventure in space. £19.95 M48K
 D/DATABASE — Ultra-fast, user friendly database using DDA. £39.95 A48K
 DDA FILES CONTROLLER — Sort, copy & restructure DDA files. £39.95 A48K
 DDA PROGRAMMER UTILITIES — Direct Disk Access for programmers. £199.95 A48K
 Demon Derby (Hyper Head-On) — 4 skill level hi-res car race game. £13.95 M32K
 EXPEDITER II — THE APPLESOFT COMPILER AT A LOW, LOW PRICE. £56.95 A48K
 Fracas — Graphics adventure for up to 8 players. £14.95 M32K
 Galaxy Wars — Colour graphics + Sound effects + Hi-Res. £13.95 M32K
 Galactic Attack — A hi-res Star Trek type game. £19.95 M48K
 Gamma Gobins — Yet another superb hi-res action game. £16.95 M48K
 Gobbler — Eat up the dots but watch out for the Gobblers. £13.95 M48K
 Gorgon — Another superb pub game for your Apple. £21.95 M48K
 Higher Graphics — Hi-res picture drawing utility. £23.95 M48K
 Hi-Res Cribbage — The title describes it. Even hear the pegs move. £14.95 M48K
 Hi-Res Soccer — English football for 1 or 2 players in hi-res. £16.95 M48K
 Jawbreaker — Hi-res machine-code action game. £16.95 M48K
 KRAM — Fast and powerful Keyed Random Access Method. £58.95 M32K
 Linker — A linking loader/editor for assembly software development. £28.95 M32K
 LISA — The assembly language development system for professionals. £45.95 M48K
 List Master — An excellent companion product to Apple-Doc. £22.95 A48K
 Memory Management System — Enables you to put DOS on a RAM card. £229.95 M64K
 Microsoft 16K RAM Expansion Card. £114.95 Card
 Missile Defense — Hi-res animation and sound arcade game. £16.95 M48K
 Mission: Asteroid — Hi-res adventure in 21 colours. Save the World!! £10.95 M32K
 MultiBoot Upgrade — Upgrade 3.2 disks to boot under 3.2 or 3.3. £23.95 M48K
 Mystery Fun House — Scott Adam's adventure on cassette. £8.95 M32K
 Mystery House — Hi-res adventure using over 100 pictures. £12.95 M48K
 Norad — A hi-res simulation of an I.C.B.M. attack. £19.95 M48K
 Olorf's Revenge — Hi-res adventure with 100 rooms. £11.95 A48K
 Olympic Decathlon — Long jump, high jump, hurdles plus much more. £17.95 M48K
 Online — A new concept in dial-up software for the Apple II. £59.95 A48K
 Operation Apocalypse — Four computer simulations of World War II. £35.95 A48K
 Orbltron — Fight off enemy forces and avoid meteor showers. £14.95 M48K
 Paddle Graphics — Draw your own pictures in 21 hi-res colours. £21.95 A48K
 Pegasus II — The latest in pub games now available for the Apple. £16.95 M48K
 Pirate Adventure — Scott Adam's adventure on cassette. £8.95 M32K
 Pool 1.5 — Hi-res colour graphics pool table simulation. 4 games. £19.95 M48K
 Pulsar II — 2 superb hi-res games on one disk. £14.95 M48K
 Pyramid of Doom — Scot Adam's adventure on cassette. £8.95 M32K
 Sabotage — Shoot down helicopters and bombers in hi-res. £13.95 M48K
 Shooting Gallery — A shooting gallery simulation in hi-res. £15.95 M48K
 Sneakers — Waves of little creatures attack you in hi-res. £16.95 M48K
 Snoggle (Puckman) — Hi-res maze of ghosts. Great fun. £13.95 M48K
 Sportporn Adventure — An adventure for adults only. £16.95 M48K
 Space Eggs — Hi-res super-fast arcade style game. £14.95 M48K
 Space Warrior — Hi-res pub game. £13.95 M48K
 Star Avenger — A fast paced game of guerilla warfare in space. £19.95 M48K
 Strange Odyssey — Scott Adam's adventure on cassette. £8.95 M32K
 SuprGraphics — A 3-D game development system in colour. £23.95 M48K
 SuperKRAM — as KRAM but with multi-key and multi-index. £99.95 M32K
 SUPERSCRIBE — WORD PROCESSOR. TRUE UPPER/LOWER CASE ON SCREEN. £73.95 M48K
 Tarturian (Wizard) — Another hi-res adventure with 160 rooms. £14.95 A48K
 TASC — An optimising Applesoft compiler from Microsoft. £129.95 A48K
 The Prisoner — A game based on the famous TV series. £21.95 A48K
 The Shattered Alliance — Swords & Sorcery on a far-flung world. £35.95 A48K
 The Warp Factor — 1 or 2 player hi-res Star Trek/Space War game. £23.95 A48K
 The Wizard and the Princess — Hi-res adventure in 21 colours. £18.95 M48K
 Threshold — Yet another fast action arcade style game. £16.95 M48K
 Torpedo Fire — A hi-res simulation of submarine warfare. £35.95 A48K
 Toxiphily — Text only adventure with split screen. VERY HARD. £9.95 A48K
 Tranquility Base — A superb moon-landing game in hi-res. £16.95 M48K
 Visicalc 3.3 — The 16 sector version with enhanced manual. £119.95 M48K
 Visidex — Store and retrieve information by key words. £119.95 M48K
 Visiterm — Use your Apple as an on-line terminal. £89.95 M48K
 Visitrend — Performs maths operations on time series data. £149.95 A48K
 Wizardry — 3-D adventure. The best we have seen yet. £28.95 M48K
 Z-Term — A full-feature terminal package for the CP/M Apple. £65.95 M48K
 A: Requires Applesoft In ROM. M: Will run on any Apple II

Please specify which DOS you require when ordering. If you don't see what you are looking for please give us a call. WE ALSO OFFER A BESPOKE SOFTWARE SERVICE WHICH IS SECOND-TO-NONE.

PRICES INCLUDE VAT AT 15%. Add 50p P+P for orders under £30 totally.

Please write or telephone for your free copy of our up-to-date software list.

Dealers inquiries invited. PERSONAL CALLERS BY APPOINTMENT ONLY PLEASE.

SPIDER SOFTWARE

98 AVONDALE ROAD,
SOUTH CROYDON,
SURREY.

Tel: 01-680 0267 (24 hours a day — 7 days a week)

● Circle No. 314

COMPEC '81

**GRAND HALL, OLYMPIA, LONDON
NOVEMBER 17-20, 1981**

(Open 10 a.m.-6 p.m. Tuesday-Thursday, 10 a.m.-4.30 p.m. Friday)

STILL THE BIGGEST ...

with over 300 exhibitors packing Olympia with computers, terminals, small business systems, peripherals, mini- and micro-computers and services

STILL THE NEWEST ...

this year COMPEC '81 has attracted over 70 completely new exhibitors. These, and the many returning companies, will be showing the very latest innovations in computer services and equipment.

STILL THE FIRST ...

to introduce new and exciting features. A new section at COMPEC '81 will be the "Software Village", specialising exclusively in software products and services.

COMPEC '81 – for adding to and improving your existing computer installations, or buying in for the first time – plan your visit NOW. See for yourself and talk to the experts, find out how tomorrow's technology can benefit your business today.

Admission to COMPEC '81 is by business registration and costs £2.00 at the door – SAVE TIME AND MONEY NOW by applying for advance half price tickets – return the coupon to us by October 30.

Post to: Compec '81 Tickets, IPC Exhibitions Ltd, Surrey House, 1 Throwley Way, Sutton, Surrey SM1 4QQ.

COMPEC '81

Please send.....advance tickets at £1.00 each (inc. VAT)

I enclose remittance of £.....(made payable to IPC Business Press Ltd)

Name

Company

Address

Sponsored by Computer Weekly, Data Processing, Systems International and Practical Computing

(Applications not accepted after October 30. No school parties, no children under 16)

PC

● Circle No. 315



The ZX80/81 DESK CONSOLE

including switches for cassette and power
Complete and Assembled

- Fits your ZX80 or ZX81
- Just plug-in. NO soldering
- Switched for SAVE/RUN/LOAD
- Both cassette and computer inputs earthed when not functional
- Switch for your 9V supply
- LED monitor for supply
- Fits 16K RAM on 80 and 81
- Fitted with base cover
- Deep enough for mains plug cluster at rear (not supplied)
- Black grain finish in ABS plastic
- Recessed for manual/pencil

Price £24.08 + £2.00 p&p UK + VAT

Send your Name, Address, (state 80 or 81) together with cheque or PO only for £29.99 to:

TTL BOX 2, WARMINSTER, WILTSHIRE BA12 7QX.
All orders acknowledged but allow 30 days for delivery.

● Circle No. 316

DATAMAZE

THE PEOPLE FOR COMPUTER CONSUMABLES

WE SUPPLY:

Floppy disks and diskettes of all types, high quality printer ribbons, daisy wheels of all types, computer stationery.

We offer fast and friendly service. Telephone for prices and details.

DATAMAZE LTD.

18 Southbury Road, Enfield,
Middlesex EN1 1SA.

Tel: 01-367 2473 or 0920 870881

● Circle No. 317

DTL-BASIC COMPILER

The only BASIC Compiler fully compatible with the full range of Commodore Microcomputers.

- ★ Up to 20 times faster when compiled
- ★ More compact object code e.g. a 24K program when compiled would run on a 16K machine
- ★ Available now on 3000, 4000 & 8000 Series machines
- ★ DTL-BASIC handles full arithmetic expressions
- ★ The compiler copes with nested loops, handles arrays and variables dynamically and accepts extensions to Basic
- ★ Thoroughly supported by a comprehensive manual and full back-up from Dataview.

Unique new security system for compiled programs for use by Software Houses — ring us for details — Colchester (0206) 865835

£360.00 + VAT
special prices for education

Dataview Ltd., Portreeves House, East Bay, Colchester, Essex.

Dataview

● Circle No. 318

Your search for the right price stops here.



Pet

Well known for making short work of accounting, word processing, mailing lists. A great buy from NSC.



Apple

You know what the Apple system will do but you don't know the deal we're offering. Come and see for yourself.



Rair

The exciting new 3/30 system offering 5 mb of fixed disc storage on brand new 5¼" Winchester drives. 64K Machine £4,313 incl. VAT. Full range of black box systems available. Rental terms available.

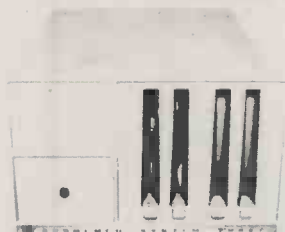

Cromemco

We can now supply the Cromix operating system for single and multi user working. The first big system operating system to be offered on a small system—the only system which offers up to 63K memory space per user.



Acorn Atom

Now available ex-stock. Special offer to ZX80 owners: We will take your ZX80 in part exchange for an Atom.

Used Bargain: Second hand ZX80's from £50.



North Star Horizon

A complete word processing system extendible from 32K-56K RAM, with up to four mini disc drives, 4MHz Z80A processor, serial and parallel I/O ports and extended BASIC. Full range of accounting packages available. You can lease this very popular system for as little as £25 per week.

Bargain Offers

We have recently been appointed agents for the Commodore VIC 20, why not call in for a demonstration. Order by post, only £199.95 including VAT.

After Sales Service

When you buy from NSC Computer Shops you have the opportunity to take advantage of a special service contract on favourable terms.

Order by post with confidence

Instead of calling personally at NSC Computer Shops you can send cash with order. Orders are despatched by carrier, please telephone for details of delivery charges.

BOOKS: Send s.a.e. for our full price list, or call in at our shop to see our wide range of publications.

Most of our prices are heavily discounted and therefore payment must accompany the order. Credit card payments will be accepted. Please quote credit card number and type of card.

WE WILL NOT BE KNOWINGLY UNDERSOLD.

NSC COMPUTER SHOPS

Computing to suit your size.

NSC Computer Shops, 29 Hanging Ditch, Manchester M4 3ES. Ring 061-832 2269 for further information.

● Circle No. 319

THE SERVICE AND
SUPPLY SPECIALISTS

SUPERBRAIN SERVICE NATIONWIDE

Responsive quality service at a
competitive rate with our
innovative contracts.

*COLLECTA-CALL * COLLECTA-CALL+



Try Calling T.S.S. for a differently better service.

Derby (0332) 883333

TERMINAL SYSTEM SERVICES LTD,
TSS HOUSE, FOUR LANES END,
HORSLEY WOODHOUSE, DERBY, DE7 6AY
TELEX 378113

*Registered trade mark.

● Circle No. 320

Connect your PET to a PRINTER from £160 + VAT

The TNW 2000 (as illustrated)
a rugged single ported bi-
directional IEEE 488/RS232
interface:

- Conversion of both PET and true ASC11.
- Daisy Chaining.
- Standard RS 232.
- Fully addressable.

The TNW 3000 – a bi-ported,
bi-directional IEEE 488/RS232
interface as per TNW 2000
plus:

- Crystal controlled Baud rate.
- Fully implemented RS232.
- Power supply for a current loop.

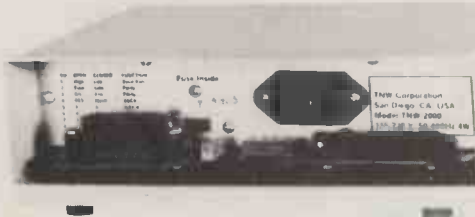

Both the TNW 2000 and 3000 are mainly used for interfacing
PETs to printers.

KINGSTON

Kingston Computers Limited, Electricity Buildings, Filey, North Yorkshire
YO14 9PJ. Telephone: (0723) 514141. Telex: 52163.

● Circle No. 321

Hard Disks for the PET

The Small Systems **HARDBOX** acts as an
intelligent controller for up to 4 Corvus
Winchester drives or one SSE Mini Winchester
drive unit.

- PET DOS 1 and 2 compatibility
- Multi user capability on Corvus Drives
- 16 Megabyte max file size
- 65535 max records per relative file
- Over 2000 files on 5 MB drive

CORVUS DRIVES

Well proven systems with nationwide support
and maintenance.

- 5, 10, 20MB capacity
- Up to 4 drives can be daisy chained
- Backup onto standard video cassette using the Mirror unit
- Up to 64 users with the Constellation multiplexer unit.

5MB Corvus drive	£2295
10MB	£3595
20MB	£4495
Mirror back up unit	£495
Constellation	£495

SSE MINI WINCHESTER

Drive and Hardbox or Softbox housed in one
small desktop unit. Single user.

Prices inc. Integral Hardbox	
3MB	£2300
6MB	£2500
12MB	£2800

Add £120 for Integral Softbox

SOFTBOX and CP/M SOFTWARE

SOFTBOX allows the PET to run the worlds
most popular operating system for micros.
Operates with PET floppies and/or a Hard disk
system.

Comprehensive range of CP/M software
available – ask for our Catalogue.

Softbox	£550
RS232 Option	£45
Corvus Option	£65

IEEE-488 INTERFACES

Comprehensive range for PET and HP-85 e.g.
B300 RS232 40 char buffer, full
handshake

£186

RICOH DAISY WHEEL PRINTERS

Letter quality, 60CPS with integral IEEE, RS232
or Centronics Interfaces.

RP1600	£1450
Flowriter	£1795
Large Buffer. Qume/Diablo compatible	
Bidirectional printing	

S100 - CP/M

Software development tools	
8048 family in circuit emulator	£850
8748 programmer	£395
Prom emulator	£295
Range of cross assemblers for most popular micros	£95
8048 BASIC compiler	£195

COMPLETE PET and HP-85 SYSTEMS

Telex 264538



small
systems
engineering
limited

2 4 Canfield Place · London · NW6 3BT

Telephone 01 328 7145 6

● Circle No. 322

SIX TOUGH QUESTIONS YOU SHOULD ASK BEFORE BUYING A MICRO.

1. Is it easy to use?
2. Are the programs versatile?
3. Is it absolutely reliable?
4. Does it have a national network of distributors and dealers offering full service and support?
5. Is it competitively priced?
6. Can you see proof of performance?

With the new Adler Alphatronic the answer is 'yes' to all these questions. Because Alphatronic is the micro that was specially designed for the small businessman. To cut paperwork, cope with accounts, payroll, stock control, VAT — and generally make business, and cash, flow more smoothly. When it comes to versatility, price, reliability and performance, Alphatronic is outstanding value.

The Alphatronic P1 costs £1600* and includes a 2000 character screen, keyboard, integral double density floppy disk unit and CP/M† disk and manual. Alphatronic P2 complete includes 2000 character screen, keyboard, two integral double density floppy disk units together with a dot-matrix printer, CP/M† disk and manual and costs £2345.*

* Prices exclusive of VAT. † Trade mark of Digital Research Corp.

FREE
 With model P1: a two disk basic teach-in course worth £85.
 With model P2: a two disk data retrieval program worth £120.
 Send back the coupon and we'll tell you how Alphatronic could be the answer — your answer.



ADLER'S NEW £1600 MICRO. BRILLIANTLY SIMPLE ALPHATRONIC.

Alphatronic Division, **TRIUMPH ADLER (UK) LTD.**
 (formerly Adler Business Systems Ltd.)
 27 Goswell Road, London EC1M 7AJ. Tel: 01-250 1717.

Please send me further details on the Adler Alphatronic.

Name

Company

Address

Telephone

PC 12/81



Printer not included on P1 model at £1600.

IBS 81 October 20-29. Hall 4 Stand 321.

● Circle No. 323

WOODLAND SOFTWARE

MAIL ORDER MICROCOMPUTER SUPPLIES FOR THE APPLE

L.A. Land Monopoly 48K A	£16.75	Hi-Res Soccer 48K M	£16.75
Hyperspace Wars 48K A	£16.75	Hi-Res Cribbage 48K M	£13.75
Odyssey 48K I	£14.75	Missile Defence 48K M	£16.75
Wilderness Campaign 48K I	£12.75	Cranston Manor 48K M	£19.75
Doom Cavern 48K I	£12.75	Sabotage 48K M	£13.75
Sneakers 48K M	£16.75	Gobbler 48K M	£13.75
Gorgon 48K M	£22.75	Higher Text 48K I	£19.75
Gamma Goblins 48K M	£16.75	Higher Graphics II 48K I	£19.75
Autobahn 48K M	£16.75	E-Z Draw 3.3 48K M	£27.75
Orbitron 48K M	£16.75	Superscript 48K M	£49.75
Pulsar II 48K M	£16.75		
Space Eggs 48K M	£16.75		
Phantoms Five 48K M	£16.75		
Cyber Strike 48K M	£21.75		
Star Cruiser 32K M	£13.75		
Both Barrels 48K A	£13.75		
Hi-Res Adventures			
Mission: Asteroid 32K M	£10.75		
Mystery House 48K M	£13.75		
The Wizard & The Princess 48K M	£18.75		
Hi-Res Football 48K M	£21.75		
		Galactic Attack 48K P	£17.75
		Wizardry 48K P	£28.75
		Infotree 48K P	£49.75

U.K. distributor for Sir-tech Inc.

Trade enquiries invited.

A = Applesoft I = Integer M = Runs on any Apple P = Requires PASCAL or DOS 3.3

All software is disk based. All prices are inclusive.

On multiple orders of 3 or more programs P&P is FREE; please add 50p P&P on orders less than 3.

A list of our full range of software is free on request . . . from

WOODLAND SOFTWARE

103 Oxford Gardens, London W10 6NF.

Tel: 01-960 4877

TRADE ENQUIRIES INVITED

● Circle No. 324

PC3201 BUSINESS COMPUTER.
C.P.U., SCREEN, TWIN DISC DRIVE,
PRINTER. **£2,995**

MZ80K
PERSONAL COMPUTER.
20K £415
48K £425

MZ80B
PERSONAL/SCIENTIFIC
COMPUTER.
64K £1,095

SHARP
First, and foremost

Full range of Sharp peripherals available. Also software and consumables.
All prices exclude delivery and VAT. Finance arrangements available.
Call in for a demonstration at our showroom
(local demonstrations on site).

N Nelson Computer Services Ltd

St. John's Court, Rawtenstall, Lancs. BB4 7PA.
Tel: Rossendale (STD 0706) 229125 (5 lines) Telex: 635615

● Circle No. 325

Explosion

Blow your mind with EXPLOSION!, a new game from LEISURE GENIUS. The object is to capture and hold opponent's squares. You build up a mine of colour in squares and when a square is filled with your colour and 'critical' you can hold it like a time bomb waiting to go off or explode into adjacent squares, making them yours. If your strategy is right, you can set off a chain reaction of explosions that can wipe your opponent off the screen!

It's exciting and totally absorbing and up to 10 of you can play! From LEISURE GENIUS, high strategy computer games you can't pass up or put down.

Also from LEISURE GENIUS, two other computer games for the better-than-average gamesplayer - DEATH, a game of biological creation and destruction, and WORMS a competitive game testing your tactics and dexterity. LEISURE GENIUS games for the Apple II are only £15.00, supplied on diskette.

Ask your dealer or write to:
Leisure Genius, Suite 504, Albany House, 324 Regent Street, London W1A 1AB
In the U.S., write to:
Leisure Genius, 34-36 83rd Street, Jackson Heights, New York, N.Y. 11375

**Leisure
Genius**

● Circle No. 326

WHY ARE 25 MULTINATIONALS C/WP CUSTOMERS?

C/WP is a long established service company based in Rochester Row, London SW1.

C/WP Computers is an Apple authorised level 1 service centre.

C/WP now offers Practical Computing readers the chance to buy at its special prices.

Apple/Visicalc offer

Apple 48K Europlus	£599.00
Disc drive with controller	£310.00
12" green monitor	£130.00
Silentype printer	£160.00
Visicalc 3.3	£100.00
	<hr/>
	£1299.00

VAT and installation extra

C/WP

C/WP Computers
01-828 3127
108 Rochester Row
London SW1P 1JP

● Circle No. 327

BUTEL-COMCO

RP1600 Daisywheel Printer



60 cps!

- * Serial V24/IEEE/Centronics interface
- * Optional intelligent version includes
 - Qume/Diablo compatible commands
 - Auto bidirectional operation
 - 2-8K buffer

Write or call for further information:

Butel Comco Limited
Garrick Industrial Centre
Garrick Road,
London NW9 6AQ
Telephone: 01-202 0262

Trade / OEM discounts available.

● Circle No. 328

BUTEL
Technology for business

MICROAGE ELECTRONICS

- * Personal Computers * TV Games
- * VCR's * Printers * Monitors * Software



**ATOM's and DAI's
ALWAYS IN STOCK**

Complete range of Atari games.
Open Mon - Sat. 9am till late.
Credit cards welcome.

NEW THIS MONTH

You
could
collect

£10 OFF

£5 voucher on goods over £100
**£5 voucher when you introduce a
new customer**

**The Seikosta 96 ASCII character
printer only £199 inc. VAT.**
Paper and cable free.

Send for price list and mail order details.
135 HALE LANE EDGWARE MIDDLESEX HA8 9QP
TEL: 01-959 7119 TELEX 881 3241

● Circle No. 329

MAGIC WINDOW £79.95
will instantly convert your Apple system into a word-processor, no modifications or fancy gadgets to buy. Magic Window's 4-way scrolling allows you to type up to 80 CHARACTERS per line!! This allows you to see your letter exactly the way it will be printed. Inserting, deleting, centring, and justifying can be done on the screen without the need to print a work copy.

BASIC MAILER £49.95
is a mailing list merge system designed to take MAGIC WINDOW document files and replace names, addresses or any other section of the document with individual data, creating customized letters, invoices, etc. Basic Mailer will save you so much time with form letters for mailing that it is hard to believe.

DAN PAYMAR LCA-2 £39.95
See true upper & lower case characters on the screen. It works with the Magic Window and other programs.

MAGIC WINDOW & MAGIC MAILER £115.00

MAGIC WINDOW, MAGIC MAILER & DAN PAYMAR LCA-2 £145.00

MICROSOFT 16K EXPANSION CARD £95.00

ANDROMEDA 16K EXPANSION CARD £95.00

VISICALC DOS 3.3 £125.00

The upgraded version of the most popular program ever.

VISIDEX £111.00

A most useful cross-reference of information. Assign multiple keywords to the index. Vary the input format as you go. Swift retrieval & printing as required.

VISIPILOT £75.00

Plot your data onto high-res. graphs. 6 formats & 6 colours.

VISITREND/VISIPILOT £144.00

Use sophisticated trend analysis techniques on your graphs.

VISICALC DOS 3.2 £75.00

Still available, the original Visicalc. Still as popular as ever.

BRAIN SURGEON £30.00

Thoroughly test your Apple II. Diagnose that tricky fault.

DB MASTER (VERSION 3) £130.00

Computed fields, statistical analysis, faster report printing.

UTILITIES

EXPEDITER £75.00
At last you can compile your Applesoft program into machine code and watch it run 2-20 times faster.

CRAE - CO-RESIDENT APPLESOFT EDITOR £14.95
Anyone Writing software on the Apple needs this editor. Global changes & finds, renumber, append, modify. 15 commands in all.

CRAE & MCAT - CATALOGUE £19.95

We carry the full range of "Sensible Software" utilities.

SUPER DISK COPY III £24.95

The best, most versatile copy program on the market. Initialize a diskette with or without the DOS sectors. Copy files one by one or the entire disk. View the catalogue & then see a display of the diskettes free & used sectors. Copy from DOS 3.2 to 3.3 & visa-versa. Many other commands.

APPLEGUARD £200.00

Protect your software !! Protect against bit copiers.

AOPT - APPLESOFT OPTIMIZER £19.95

Optimize your Applesoft program, remove REM's, pack as many instructions as possible per line.

APLUS - STRUCTURED BASIC £19.95

Write programs in a structured manner with your new additional commands and then compile into a regular Applesoft program.

DOS PLUS £19.95

3 new Dos Commands built-in, 5 commands are user-definable. You can now FLIP easily between Dos 3.3/3.2 from within the program. Also Dos Command Editor. Edit the names of the Dos commands and initialize disks with your own DOS.

DISK RECOVERY - "THE SCANNER" £24.95

Scan your disks and mark faulty tracks so they are not used. Also able to REDO VTOC which may recover your 'messed-up' disk.

BACK-IT-UP £50.00

Bit copier - to back up your software.

ARCADE GAMES

Space Warrior	£12.95	Star Cruiser	£12.95	Sneakers	£16.95
Alien Rain	£12.95	Alien Typhoon	£13.95	Raster Blaster	£16.95
Snoggle	£12.95	Space Eggs	£14.95	Star Thief	£16.95
Demon Derby	£12.95	Autobahn	£14.95	Missile Defence	£17.95
Galaxy Wars	£12.95	Star Mines	£14.95	Epoch	£19.95
Gobbler	£12.95	Apple Panic	£14.95		

ADVENTURE GAMES

Mission Asteroid	£9.95	Oldorf's Revenge	£11.95
Mystery House	£12.95	Tarturian	£14.95
The Wizard & Princess	£17.95	Creature Venture	£14.95
Cranston Manor	£17.95	Soft Porn Adventure	£17.95

CARD GAMES & SPORTS GAMES

German Whist	£9.95	Pool 1.5	£18.95
Cribbage	£12.95	American Football	£19.95
Draw Poker	£14.95	Hi-Res Soccer	£22.95

STRATEGY GAMES

Galactic Empire I	£12.95	Tawala's Last Redoubt	£14.95
Galactic Trader II	£12.95	Golden Mountain	£9.95
Galactic Revolution III	£12.95	Kubik	£9.95

Add 15% VAT, Postage & Packing Free.

Write or phone for full catalogue. Dealer enquiries welcome.

CONTACT:

S. B. D. SOFTWARE
15 Jocelyn Road, Richmond TW9 2JT
Tel: 01-948 0461

● Circle No. 330

ANGLIA COMPUTER CENTRE

SPECIALISTS IN MICROCOMPUTERS FOR BUSINESS,
AND SCIENCE

88 ST. BENEDICT'S STREET, NORWICH NR2 4AB.

TELEPHONE: (0603) 29652

From the **LARGEST EAST ANGLIAN**
Microcomputer specialists and **APPLE II DISTRIBUTORS:**
Trade in your "PET" for something better!!!
Apple II still only £799.00 at ANGLIA plus
FREE 'Anglia Invaders' or 'Microchess' programme.

SPECIALIST EQUIPMENT AND PROGRAMMES FOR APPLE II

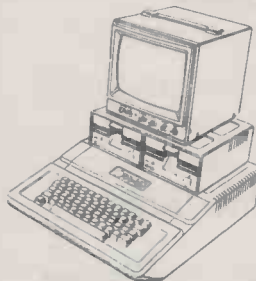

**ANGLIA FOR
APPLES AND
MUCH MORE!!**

No. 1 UNIQUE GRAPH PLOTTING SOFTWARE FOR THE DIGIPLLOT!!!

To plot graphs created by 'Apple Plot' and 'Visicalc'

DIGIPLLOT	£895.00
APPLE PLOT	£37.00
VISICALC	£111.00
DIGIPLLOT SOFTWARE	£105.00

(FREE when you purchase 'Digiplot' from us)

No. 2. SOFTWARE INTERFACE BETWEEN 'GRAPHICS TABLET' AND 'DIGIPLLOT' £95.00
(FREE when you purchase either 'Graphics Tablet' or 'Digiplot' from us)

No. 3. Get the most versatile and low cost printers for your Apple II and take advantage of its versatile character set from within 'Apple Writer' by using the **EPSON/APPLE WRITER ADVANCED CHARACTER GENERATOR** £49.00
(FREE if you purchase an Epson Printer and Apple Writer from us)

No. 4. **CASHBOOK PROGRAMME** suitable for personal, departmental, societies or institutional use £95.00

No. 5. **COSTING** your production of **ASSEMBLED PRODUCTS** includes Stock Control and Price Update of individual items (written in Pascal) £650.00

No. 6. **PROPERTY RENTAL** — suitable for Estate Agents.

No. 7. **EXAM TIME** — save yourself time in preparing Multiple Choice Questions and After Exam Tuition. Suitable for schools, colleges and industry training £49.50.



EPSON PRINTERS

Epson MX80 F/T	£399.00
Above with graphics	£450.00
Epson MX100	£575.00
EPSON MX130	CALL
Epson Apple Interface with cable ..	£60.00

APPLE III—STILL WAITING???

APPLE II's are hard at workon **THE HARD DISK NETWORK**

SEE IT RUNNING at our showroom and save your company £1000s on Minicomputers or Mainframes



INVOICING
& SALES



PURCHASES



WORD
PROCESSING



FINANCIAL
PLANNING



BASIC



PASCAL



COBOL

HARD DISC

Are you still trying to grasp computing with a ZX80/81? — we will trade your ZX80 OR ZX81 for something better!!!

Starting with **ACORN ATOM**

We are full stockists of all Acorn Atom products and programmes plus our own.



The **ANGLIA ATOM MONITOR** to help you into the heart of machine code computing £14.95
(FREE with every assembled Atom purchased from us **FAST DELIVERY.**)

We also stock the Seikosha GP80 Printer and Atom connecting cables.

ENGINEERS! DRAUGHTSMEN! DESIGNERS! ARCHITECTS!

Enter the drawing office of the future today with this revolutionary Microcomputer-based draughting machine for as little as £1.00 per hour.



WE ALSO DISTRIBUTE: Anadex ... Tandy TRS-80 ... Tangerine ... Tante! ... North Star ... Video Genie ...
Qume ... Paper Tiger ... Olympla ... Centronics ... Starwriter ... Sharp ... Texas Instruments TI/99/4.

TELEPHONE: (0603) 29652.

All prices quoted exclude VAT.

Note: Soon opening other branches in East Anglia and London. Sales and Technical Staff required. Interested parties please apply in writing.

WORD PROCESSOR LETTERHEADS

Mounted on carrier band or
printed onto white continuous
bond paper

.....
Continuous
Self Adhesive Labels
1-2-3 wide in various sizes

.....
Listing Paper
single and multipart

.....
Diskette and Listing Paper
Storage Systems

.....
For further information please contact:

Printout Business Forms

Phone Fleet (Hants) 02514 24167
or FREEPOST Fleet ALDERSHOT
Hampshire GU13 9BR. (No stamp required)

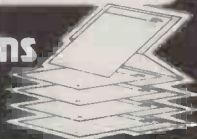

● Circle No. 332

★ NEW BROOM FOR EPROMS ★ TEX ERASER SWEEPS CLEAN!

EPROMPT is Prompt Enough!



Eproms need careful treatment to survive their expected lifetime. Rushing it could burn their brains out. So cop-out of this helter-skelter world; take it easy the TEX way and give your chips a well-earned break. Cool, gentle and affordable; EPROMPT does it properly.

★ 16-chip basic economy EPROMPT EB: £32 nett; £39 c.w.o. ★
★ 32-chip interlocked de-luxe EPROMPT GT: £40 nett; £49 c.w.o. ★



*TEXTIME
is
Tea-Break Time!*

Our EPROMPT needs just half-an-hour to finish its job; this is the proper erase time for all Eproms. While it's busy you may as well take a break yourself, but don't take too long without a timer on the job; over-erasing can shorten data storage time. So our TEXTIME will remember to turn out the light and your chips will forget nothing new.

★ 30-minute solid-state TEXTIME M30: £15 nett; £19 c.w.o. ★
★★★ Special Offer EB + M30: £45 nett; £55 c.w.o. ★★★
★★★ Special Offer GT + M30: £53 nett; £66 c.w.o. ★★★

TEX: Reliable quality at affordable prices. We manufacture in the U.K. and sell direct. All items ex-stock from St. Albans or Watford Electronics.

C.W.O. Prices include Carriage & VAT. Write post-free: **BOX 12;**
TEX MICROSYSTEMS LTD. FREEPOST
ST. ALBANS, HERTS. AL1 1BR ST. ALBANS 64077/TRING 4797 ANYTIME

● Circle No. 333

THE STYLIST

a high quality daisy wheel printer



£695
+VAT

- V24/RS232 interface
- Proportional spacing
- Bidirectional/logic seeking
- Wide range of type styles and international languages

Trade/OEM Discounts available

Write or call for further information:

Butel-Comco Limited, Garrick Industrial Centre, Garrick Road, London NW9 6AQ. Telephone: 01-202 0262.

BUTEL
Technology for business

● Circle No. 334

Dual-density
Model
ONLY £1,750*

Leasing and
Rental
Facilities
Available



Superb
Budget-priced
W.P. System
FOR ONLY
£2,995*

=

SPEEDY SOLUTIONS to your unique BUSINESS PROBLEMS

We build systems to SUIT YOUR BUSINESS and MAKE IT MORE EFFICIENT!!
We *don't* ask you to change your business to suit an off-the-shelf package!!

Our professional consultants using Advanced Software Development Techniques can produce a system to meet your needs for now with the built-in flexibility for tomorrow's expansion.

All in a fraction of the time it normally takes to develop a "Made-to-Measure System" with corresponding SAVINGS on your software costs.

For free consultation and demonstration contact:

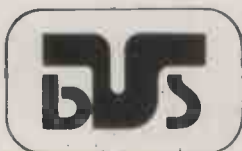

VISION BUSINESS SYSTEMS LTD.,
58 ST. PETER'S STREET, ST. ALBANS, HERTS.
TELEPHONE: ST. ALBANS (0727) 33744

*Prices may be subject to change due to the fluctuation of the dollar rate.

● Circle No. 335

systems ltd.

A/D BOARD FOR NASCOM

- ★ 8 input channels
- ★ 30 microsec conversion
- ★ Over voltage protection
- ★ Prototyping area
- ★ 8 bit resolution
- ★ Sample and hold
- ★ Full flag/interrupt control
- ★ NASBUS compatible

Price: £135 + 15% VAT (post free)

GRAPHICS BOARD FOR NASCOM

- ★ 384 (H) x 256 (v) high resolution graphics display
- ★ fully bit mapped
- ★ full software control
- ★ graphics software supplied
- ★ mixed text and graphics
- ★ NASCOM 2 or 4mhz
- ★ NASCOM 1

Price: £55 + 15% VAT (post free)

EPROM PROGRAMMER

- ★ Programs 3 rail: 2708/2716
- single rail: 2508/2758
- 2516/2716
- 2532/2732
- ★ Software supplied for READ/PROGRAM/VERIFY
- ★ CAN BE USED WITH OTHER M/Cs WITH 2 PARALLEL PORTS

Price: £63 + 15% VAT (post free)

DUNCAN

- ★ Fast real time interpreter/control language for NASCOM 1 or 2 (please specify)

Price £12 + 15% VAT (post free)

MEMORIES

4116 — 150ns, 95 pence each + VAT (min 8)

64K — 200ns £10 each + VAT

MONITORS

BMC 12" green phosphor, 18mhz.
Price: £175 + 15% VAT (carriage extra)

6 Laleham Ave, Mill Hill, London NW7 3HL
Tel: 01-959 0106



● Circle No. 336

UNIVERSITY OF MANCHESTER

EXTRA-MURAL DEPARTMENT

Four residential courses to be held at Holly Royde Residential Conference Centre, Manchester.

BASIC, BASIC PROGRAMMING

Friday-Sunday, 29th-31st January, 1982.

Fee: Resident £75 which includes full board and tuition.

ALL YOU EVER WANTED TO KNOW ABOUT CBM FLOPPY DISKS

Friday-Saturday, 5th-6th February, 1982.

Fee: Resident £59 which includes full board and tuition.

LEARN BASIC, PRACTICAL BASIC

Monday-Friday, 22nd-26th March, 1982.

Fee: Resident £189 which includes full board and tuition.

MACHINE CODE PROGRAMMING ON THE PET

Friday-Sunday, 20th-22nd August, 1982.

Fee: Resident £75 which includes full board and tuition.

For full details please contact Mrs. Sue Eden, Extra-Mural Department, The University, Manchester, M13 9PL or telephone 061-273 3333 ext 3076.

● Circle No. 337

LEEDS COMPUTER CENTRE

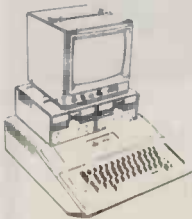

 apple II EUROPLUS

VIC ²⁰ + £175 'INCLUDING VAT' P/P £3—

48K £625 + VAT
Disk with controller £360 + VAT
Disk without controller £275 + VAT
Monitors b/w or green.
Full range of Peripherals, Epsom and Paper Tiger printers all discounted, Post & Packing £4.

Price includes fully tested unit with fitted plug.

Complete range of Vic-Peripherals.

Telephone
your
order
NOW

 COMMODORE PET

NEW

4000SR. WITH LARGE 12" GREEN SCREEN

32K MODEL P-P- £5.00 **£555** + VAT

Access
and
Barclaycard
accepted

COMPLETE RANGE OF COMMODORE EQUIPMENT EX-STOCK

Official orders welcome: goods dispatched 24hr delivery. Please phone for our lowest prices.

SALES

SERVICE

SATISFACTION

ADVANCED COMPUTER EQUIPMENT (LEEDS) LTD

95 MEADOW LANE, LEEDS 11

PHONE: 0532 446960

TELEX: 335909

● Circle No. 338

A POWERFUL MULTI-USER SYSTEM FOR UNDER £6,600.

From as little as £6500.00 (plus VAT) you can enter the world of multi-user distributed processing with the CLENLO ACE MULTI-USER SYSTEM.

The only genuine Micro multi-processor system readily available with the full range of multi-user facilities.

With the CLENLO ACE multi-user system up to sixteen users each have exclusive use of a Z-80A processor and 64K RAM mounted on a S-100 board, each with a serial RS-232 I/O port to which the user's VDU is attached.

The multi-user system is housed in a standard S-100 mainframe chassis enabling individual users to run programs independently and simultaneously, while still having access to shared resources (hard disc storage, printers etc.) – via the S-100 BUS Inter Processor Communication channel.

All this activity is controlled by a DPC/OS multi-user operating system running in a Service Processor and creating a complete CP/M Ver 2.2 environment for each user.

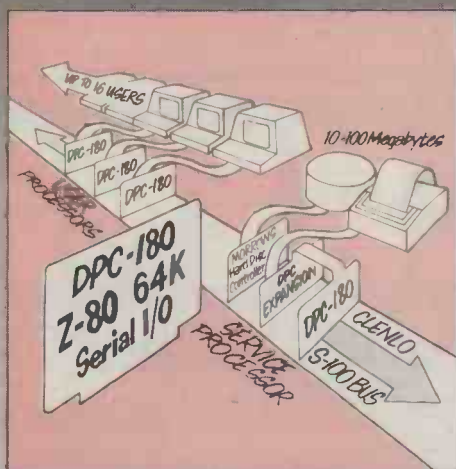

CLENLO
Microcomputers
designed for business

The CLENLO ACE multi-user system supports full multi-user facilities...

- Full lock-out at record level
- Facility to designate files – private, group or public
- Full 4MHz speed for each user
- Fast memory to memory data transfer
- Enhanced batch submit facility
- Floppy disc storage, or Winchester hard disc storage up to 100 Megabytes.

- Automatic print spooling and de-spooling.
- Tape back-up facilities available... backed up by the exceptional CLENLO service and highly competitive prices.

Whether you want a basic two user system incorporating floppy disc storage or the facility of a full sixteen user hard disc based system with high performance, CLENLO can provide the system you need.

For more details of the best, lowest cost multi-user system on the market and our complete range of Microcomputer and business services contact Tom Spencer, CLENLO COMPUTING SYSTEMS, Telephone 01-670 4202/3.

To: CLENLO COMPUTING SYSTEMS LIMITED,
Crown House, 18 Gypsy Hill, London SE19 1NL.
Telephone: 01-670 4202/3.

- Please send me details of your ACE MULTI-USER SYSTEM.
- Please send me details of the complete CLENLO range.

Name _____

Position _____

Company _____

Address _____

Telephone _____

BRITISH S100 BOARDS

DESIGNED AND MANUFACTURED IN ENGLAND
BY

INTERACTIVE

SBMC	4 MHz, Z80A processor with 1K RAM, sockets for 16K EPROM, 2 RS232 serial ports and Z80CTC.	£235.00
Z8 OCPU	4 MHz, Z80A processor card.	£105.00
16K SRAM	16K bytes static RAM using low power 2114 chips.	£157.00
8K SRAM	8K bytes version of above.	£98.00
DFDC	Floppy Disc Controller, single/double density, single/double sided, mixed 5.25 and 8" drives, up to 4 in total.	£219.00
CP/M	CP/M 2.2 Disk Operating System, tailored for SBMC and DFDC. Please state 5" or 8".	£85.00
TERM40	Active Termination Board. Prevents ringing and noise on the bus.	£35.00
VID1	I/O Mapped Video Controller with centronics type printer port.	£265.00
PSU	Heavy duty S100 power supply.	£155.00
15M.BD	15 slot Mother Board with edge connectors and active termination.	£98.00
7M.BD	7 slot Mother Board with edge connectors and active termination.	£66.00

All prices are for assembled and tested boards, we do not sell 'Bare Boards'.
15% VAT should be added to all orders, c.w.o. only. Technical data sheets available for most products, educational and quantity dealer/OEM enquiries welcome.

Further details from:—
INTERACTIVE DATA SYSTEMS LTD.,
14, Heathfield,
Stacey Bushes,
Milton Keynes,
Bucks, MK12 6HP.

Tel. 0908 313997

*Inter
active*
DATA SYSTEMS
Taking the mystery out
of microchips

● Circle No. 340

NOW IN STOCK

All products carry 6 months guarantee
with 24 hour replace/repair turnaround.

8" Single Sided Drive	£250.
8" Double Slided Drive	£340.
BFD 81-S: 1 x Single Sided Boxed 8" Drive	£370.
BFD 81-D: 1 x Double Sided Boxed 8" Drive	£460.
BFD 82-S: 2 x Single Sided Boxed 8" Drive	£710.
BFD 82-D: 2 x Double Sided Boxed 8" Drive	£890.
BFD 83-S: 3 x Single Sided Boxed 8" Drive	£1020.
BFD 83-D: 3 x Double Sided Boxed 8" Drive	£1290.

AVAILABLE IN THE NEW YEAR

INTEGRATED I/O EXPANSION SYSTEM FOR UK101 (AND SUPERBOARD)

Comprises boxed 8 slot I/O Motherboard and power supply. Motherboard has capability for 5 byte-wide EPROM/RAM devices. I/O Boards are Eurocard size and the following are under development:—

multi-PIA
multi-ACIA
multi-VIA
PROM PROGRAMMER

SOUND GENERATOR
ANALOGUE I/O
SWITCH I/O
DISK CONTROLLER

COMPUTRONIX

192 Birchgrove Road
Birchgrove, Swansea
West Glam.
Tel: (0792) 813551

CWO + VAT
P.P. charged
at cost

● Circle No. 341

TWICKENHAM

COMPUTER CENTRE LTD

With the best microcomputers available



1/2 day Wednesday - 'phone for latest Prices

PRINTERS

Anadex
Epson
Ricoh

SOFTWARE

Micro Modeller
Visicalc
Magic Window

ACCESSORIES

Z-80 Softcard
Monitors
Graphics Tablet

NEW TO OUR RANGE *Prestel with* **anel** £170.00 + VAT.

01 - 892 7896
01 - 891 1612

**TWICKENHAM COMPUTER
CENTRE LIMITED**

72, Heath Road Twickenham Middlesex TW1 4BW

VISA

● Circle No. 342

NOW YOUR HP-85 IS COMPLETE



WITH THE MSC-9800H 5.0Mb WINCHESTER DRIVE

- 45ms access time.
- 22 bit error detection/11 bit error correction.
- 256 byte data buffer.
- Software compatible with HP9895 floppy drive.
- Compact desk top unit measuring 6 $\frac{3}{8}$ " x 10 $\frac{1}{2}$ " x 12".
- Low cost per byte.

JUST PLUG IN AND RUN!! . . . OTHER MODELS AVAILABLE.
MSC-9800 — STANDARD IEEE-48/MSC-9800 L-HP9800 SERIES COMPATIBLE.

U.K. DISTRIBUTORS:

ANGLIA COMPUTER CENTRE

88 ST. BENEDICTS STREET,
NORWICH NR2 4AB.

TEL: (0603) 29652/26002.

AS SHOWN AT COMPEC 1981
DEALER ENQUIRIES
WELCOME

Tired of hearing about PASCAL?

We think you've waited long enough.

At last, there is an easy to understand Pascal sampler to help you learn Pascal programming, LinkSampler. And to fill the needs of the Pascal programmer, two Pascal utility programs to increase your programming productivity, LinkVideo and LinkDisk.

Link Systems backs its commitment to quality Pascal software with fifteen years of mainframe and micro computer programming experience.

The Easiest Way to Learn Pascal

● **LinkSampler** is an entertaining Pascal learning tool, supplied with easy to understand documentation. LinkSampler includes a full diskette of games, math procedures and financial programs.

LinkSampler I will help you put into practice what you have read in books.

£49.95

An Interactive Pascal Utility

● **LinkDisk** fills the needs of the programmer for manipulating individual bytes of Pascal mass storage media.

It compares, examines and changes any byte on an Apple Pascal disk and translates DOS Basic into Pascal.

Compare.

This function enables you to insure that a disk copy was performed without error, and the copy is readable. Good for Pascal and Basic.

Examine.

Enables you to examine and change data on mass storage, change data byte by byte and alter any nibble of data.

Translate.

Enables you to translate DOS 3.3 text and Binary files into Pascal. £54.95

A Multi Function Programmers Aid

● **LinkVideo** saves valuable input, output programming time, and provides terminal independence for essential screen functions.

- Erase to End of line.
- Erase to End of Screen. ● Clear Screen.
- Cursor Moves (both input and output).
- Line and Screen Erasure.
- Filters, Validates and prompts input for Strings, Fields, Boolean, Social Security Numbers, Telephone Numbers, Dates, Integers, Pseudo-Reals. £44.95

LINKO SYSTEMS

U.K. DISTRIBUTORS:

ANGLIA COMPUTER CENTRE

88 ST. BENEDICTS STREET,
NORWICH NR2 4AB.

TELEPHONE:
(0603) 29652/26002.

(All prices exclude VAT)

DEALER ENQUIRIES
WELCOME

● Circle No. 343

BIG EARS

**SPEECH
INPUT
FOR
YOUR
COMPUTER!**

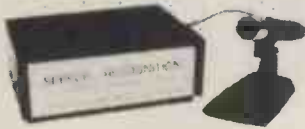

BIG EARS opens the door to direct man-machine communication. The system comprises analogue frequency separation filters, preamps and signal conversion, together with a quality microphone and extensive software.

Words, in any language, are stored as "voice-prints" by simply repeating them a few times in "learn" mode. Using keyword selection techniques, large vocabularies can be constructed.

Use **BIG EARS** as a front end for any application: data enquiry, robot control, starwars — the possibilities are unlimited.

BUILT, TESTED & GUARANTEED ONLY £49!

PRICE INCLUDES POSTAGE & PACKING. PLEASE ADD VAT AT 15%
PLEASE STATE COMPUTER UK101, SUPERBOARD, NASCOM2,
PET, TRS80, ETC.

MICROGRAPHICS

Colour Conversion for UK 101/NASCOM 1 & 2/
Superboard
(Modulator included)

**KIT £45
BUILT £60**

COLOUR MODULATOR

RGB in, PAL/UHF.out

**KIT £12
BUILT £18**

Please add VAT at 15% to all prices

Barclaycard/Access orders accepted on telephone



**WILLIAM
STUART
SYSTEMS Ltd**

Dower House, Billericay Road,
Herongate, Brentwood,
Essex CM13 3SD.



Telephone: Brentwood (0277) 810244

● Circle No. 344

NOW OPEN CLEARSONS COMPUTER SUPPLIES CASH & CARRY CENTRE OPEN SIX DAYS A WEEK

For you to browse our vast selection of computer supplies, bring this advert for 10% discount.

SPECIAL OPENING OFFER

Verbatim Datalife Diskettes

MD25 single sided — £16.00 per 10 plus VAT
MD550 double sided — £22.50 per 10 plus VAT
Pet/Anadex Ribbons — £1.00 each plus VAT
Accomedia mini diskette box with index holds 50
diskettes — only £19.99 plus VAT

Take advantage of our bulk buying all available
from stock.

Post free on these items.

Also free design and advisory service for printed
forms.

CLEARSONS LTD,
Camp Road, Farnborough, Hants.
(0252) 518022/518717/41313.

● Circle No. 345

TECPACS

The reliable technical programs for desktop computers

TECPACS are high-quality, technical software packages, written and tested by professionals for professionals. They can be used in your office, no large centralised computing facilities are needed, and computing experience is unnecessary. With TECPACS, designers and engineers can explore design alternatives with ease and confidence.

TECPACS offer such features as

- Built-in high technical standard
- Easy to use, friendly style

- Data checking facilities
- Trend facilities
- Choice of units
- High-quality presentation of results

Typical TECPACS available now include:

- FUNKIT-1, evaluates and plots any function (up to 100 characters long, any number of variables) £100
- POLYNOMIAL evaluation and analysis (root finding, integration etc) £80
- GRAPHKIT, graph plotting,

curve fitting, non-linear regression £80

- HISTOKIT, high resolution histograms, univariate statistics. £80

TECPACS add another professional to your team. In your office, or in the design office, just switch on, select your TECPAC program disk, and in minutes you have the answers you need.

For further details,
of TECPACS available contact the:
Technical Software Centre
BHRA Fluid Engineering
Cranfield, Bedford MK43 0AJ
England
or telephone Dr Eugene Sweeney on
0234 750 102

Technical Software Centre
tecpac

For use with PETS, APPLES
and other machines.

● Circle No. 346

HENRY'S

COMPUTER KIT DIVISION

TANGERINE COMPUTER SYSTEMS
LONDON & HOME COUNTIES STOCKISTS

ALL PRE-PAID
ORDERS
POST FREE

RETAIL SALES & DEMONSTRATIONS

404 EDGWARE RD. LONDON, W2 1ED TEL: 01-402 6822

TANGERINE • TANGERINE • TANGERINE • TANGERINE • TANGERINE

MICROTAN 65

Microtan 65 is the most advanced, powerful, expandable micro-computer available - it also happens to be the most cost effective!

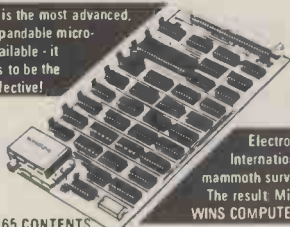

Electronic Today International held a mammoth survey of kits. The result, Microtan 65 WINS COMPUTER CLASS!

MICROTAN 65 CONTENTS

High quality, plated thru hole printed circuit board, solder resist and silk screened component identification. 6502 microprocessor. 1K monitor TANBUG. Now with 'V' Bug. 1K RAM for user programme, stack and display memory. VDU alphanumeric display of 16 rows by 32 characters. MICROTAN 65 system file binder. 136 page, bound, users hardware/software manual with constructional details and sample programmes. Logic and discrete components to fully expand MICROTAN 65.

The MICROTAN 65 kit has won widespread acclaim for its superb presentation. We pay attention to detail!

KIT FORM £69.00 + £10.35 V.A.T., total £79.35

MICROTAN 65 assembled and tested. Specification as above, but assembled and fully bench tested by ourselves. £79.00 + £11.85 V.A.T., total £90.85

TANBUG V2.3 KIT

(Separately) £21.85 incl.

MICROTAN 65 OPTIONS

LOWER CASE PACK

Two integrated circuits which connect into locations on MICROTAN allowing 128 displayable characters

£9.48 + £1.42, total £10.90

GRAPHICS PACK

Five integrated circuits which connect into locations on MICROTAN allowing the display of chunky graphics (64 x 64 pixels). What are chunky graphics? Well, imagine a piece of graph paper with 64 squares vertically and 64 squares horizontally, a total of 4096. Each square can be made black on white.

£6.52 + V.A.T. 98p, total £7.50

20 WAY KEYPAD

Inexpensive means of getting up and running. Uses 'Schoeller' key-switches, and connects to MICROTAN through a 16 pin D.I.L. plug on ribbon cable. Black anodised escutcheon, with TANGERINE legends. Finishes off what must be the best value for money keypad available. Available assembled and tested.

£10.00 + V.A.T. £1.50, total £11.50

*Space Invaders game (for use with keypad only)

£15.22 + V.A.T. £2.28, total £17.50

POWER SUPPLIES

MPS 1 Input 120 or 240V AC. Output 5 Volts at 3 Amps Regulated. MPS 1 will power both MICROTAN and TANEX fully expanded. Built on the same size printed circuit board as MICROTAN etc. Available as a fully built and tested unit.

£23.00 = V.A.T. £3.45, total £26.45

X MPS2 +5V 6A, +12V, -5 and -12V switch mode system PSU

£69.13 + V.A.T.

MINI-SYSTEM RACK

We have produced a mini-system rack which accepts MICROTAN 65, TANEX and our mini-mother board. It has an integral power supply, just plug it into the mains and away you go! Finished in TANGERINE/BLACK, it gives your system the professional finish. Front panel access for I/O cables. AVAILABLE AS AN ASSEMBLED UNIT.

£56.35 incl.

FULL SYSTEM RACK

For the man that has everything! 19 inch wide system rack which accepts MICROTAN 65, TANEX, TANRAM, SEVEN FURTHER EXPANSION BOARDS, TANDOS and THE SYSTEM POWER SUPPLY. Available in many formats, e.g. individual front panels, full width hinged front panel, back panel with or without connectors.

£49.00 + V.A.T. £7.35, total £56.35

MICRON COMPUTER

FULLY BUILT, TESTED, and housed

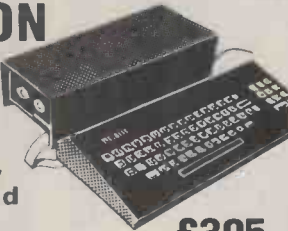

£395

SYSTEM RACK MICRON £550.00 incl. inc V.A.T. P&P
6502 based microcomputer. VDU alpha numeric display. Powerful monitor TANBUG. 8K RAM. 32 parallel I/O lines. 2 TTL serial I/O lines. Four 16 Bit counter timers. Cassette interface. Data bus buffering. Memory mapping control. 71 key ASCII Keyboard, including numeric keypad. Includes power supply. Also includes the first '10K MICROSOFT BASIC' available in the U.K. All the usual BASIC commands.

Full manuals (Microtan, Tanex, Basic, X Bug, All **£5.00** each.



TANRAM

AVAILABLE NOW TANRAM - 40K Bytes on one board! Single board of bulk memory offering 7K Static RAM (2114), and 32K Dynamic RAM (4116). Onboard refresh is totally transparent to CPU operation and is unaffected by normal DMA's. TANRAM fully expands the available address space of the 6502 microprocessor. MICROTAN, TANEX and TANRAM together provide 16K RAM, 48K RAM, and 1K I/O - that's a lot of memory and a lot of I/O! Built and tested. TANRAM ASSEMBLED

40K RAM CARD with 16K DYNAMIC RAM £76 + V.A.T.

CONTENTS: High quality plated thru hole printed circuit board, solder resist and silk screened component identification. Full complement of I.C. sockets for maximum expansion. 64 way DIN edge connector. 1K RAM (2114). Data bus buffering. TANRAM users manual. EXTRA RAM:

1K STATIC (2114) £2.95 each 16K DYNAMIC (4116) £1.50 each

MEMORIES EXPAND YOUR SYSTEM WITH OUR TANGERINE Discounts 10% for 4, 15% for 8, 20% for 16. APPROVED CHIPS.

2102 1K x 1 Static RAM 80p IM 6402 UART £4.50

2708 £3.50 2114 1K x 4 Static RAM £2.95

2716 £6.50 MK 4116 16K x 1 Dynamic RAM 4118 1K x 8 Static RAM £7.50

£1.50 All including VAT

MONITORS (PROFESSIONAL)

RECONDITIONED AND NEW - FROM £35.00 to **£129.95**

CENTRONICS Ideal for Tangerine PRINTERS

SHEIKOSHA **£199 + V.A.T.**

Model 730 **£350 + V.A.T.**

Model 737 **£395 + V.A.T.**



NEW MICROTANTEL POST OFFICE APPROVED PRESTEL - VIEWDATA

● FULL COLOUR GRAPHICS ● CAN STORE PRESTEL ● CAN BE USED AS AN EDITING TERMINAL ● CAN BE INTERFACED WITH PET, APPLE, etc.

£170

+ V.A.T.

Just connect to the aerial socket of any colour or black and white domestic T.V. receiver and to your Post Office installed jack socket and you are into the exciting world of PRESTEL. Via simple push button use you are able to view 170,000 pages of up to the minute information on many services, order goods from companies - all this without leaving your armchair!

TANEX £43.00

Minimum Config Kit. + V.A.T. £6.45, total £49.45

CONTENTS

High quality plated thru hole printed circuit board, solder resist and silk screened component identification. I.C. sockets for maximum expansion. 64 Way DIN edge connector. 1K RAM, cassette interface, 16 parallel I/O lines, a TTL serial I/O port, two 16 bit counter timers, data bus buffering, memory mapping, logic and discrete components for maximum expansion. TANEX users manual. TANEX (Minimum configuration) Assembled **£53.00 + V.A.T. £7.95, total £60.95**



TANEX EXPANSION

Expanded TANEX offers: 7K RAM, locations for 4K EPROM (2716), locations for 10K extended MICROSOFT BASIC, 32 parallel I/O lines, two TTL serial I/O ports, a third serial I/O port with RS232/20mA loop, full modem control and 16 programmable baud rates, four 16 bit counter timers, cassette interface, data bus buffering, and memory mapping.



EXPANDED TANEX KIT (Excludes ROM, XBUG and BASIC) £89.70 + V.A.T. £13.46, total £103.16.

EXPANDED TANEX ASSEMBLED £99.70 + V.A.T. £14.96, total £114.66

OPTIONS TO FULLY EXPANDED TANEX

10K Extended MICROSOFT BASIC in EPROM (with manual) £49.00 + V.A.T. £7.35, total £56.35

Extra RAM 1K (2 x 2114) £5.20 + V.A.T. 78p, total £5.98

SERIAL I/O KIT £17.25 incl.

6522 VIA £8.00 + V.A.T. £1.20, total £9.20

XBUG £17.35 + V.A.T. £2.60, total £19.95

± 12V KIT £9.20 incl.

AS YOU CAN SEE THE PRICES OF OUR EXPANSION

ITEMS ARE VERY, VERY COMPETITIVE!

TANGERINE DISC SYSTEM

Z80 CONTROLLER CARD **£150.00 + V.A.T.**

DOUBLE SIDED DOUBLE DENSITY DRIVE **£215.00 + V.A.T.**

CP/M DISK OPERATING SYSTEM **£80 + V.A.T.**



71 KEY ASCII KEYBOARD £69.95 incl.

NO EXTRAS NEEDED.

Uses gold crosspoint keys. Includes numeric keypad and ribbon cable.

Available as fully assembled and tested.

SUPER METAL CABINET IN TANGERINE/BLACK

£20.00 + V.A.T. £3.00, total £23.00



PROFESSIONAL ASCII KEYBOARDS Ideal for Tangerine

£29.95 + V.A.T.

52 key 7 bit ASCII coded

Positive strobe +5V-12V

Full ASCII characters

Parallel output with strobe

Power light on control

Chip by General Instrument

(G.I.) TTL output



- Superbly made
- Size 13 x 5.5 x 1.5 ins.
- Black keys with white ledgens
- Escape shift return & reset
- Chip by General Instrument
- Complete with DATA

ADD-ON KEYPAD

A compact 12 button keypad suitable for use with above keyboard to extend its functions plus four extra keys. Supplied brand new with with data. A 4 x 4 non-encoded single mode keyboard.

LIST PRICE £22.00
OUR PRICE **£7.95**
- V.A.T.

PLUS MANY NEW EXCITING PRODUCTS IN DEVELOPMENT AUTOMATICALLY AVAILABLE FROM US WHEN RELEASED BY TANGERINE LTD. All products are available FULLY GUARANTEED ● BUY WITH CONFIDENCE BRITISH DESIGN & MANUFACTURE AND ON DEMONSTRATION IN OUR COMPUTER DEPT

NEW PRODUCTS (All V.A.T. incl.)

System Motherboard (4 Connector)	44.85	Serial I/O Board Min (2 Ports)	66.70	AIM/KIM Buffer	54.84
System Motherboard (12 Connector)	72.85	Serial I/O Board Max (8 Ports)	135.70	Controller Card Full	138.00
Extra Edge Connectors	3.50	Parallel I/O Board Min (16 Lines)	54.63	Controller Card Min	69.00
System Rack Front Panel	15.64	Parallel I/O Board Max (128 Lines)	99.48	CBUG, Combined Tanbug & XBUG	T.B.A.
		32K Ramcard 16K Version	87.40	2 Port, Serial I/O Kit	90.85
		32K Ramcard 32K Version	115.00	High Resolution Graphics	79.35
		32K Ramcard (Excel Rom)	54.65	Aim TV Interface	

TANGERINE • TANGERINE • TANGERINE • TANGERINE • TANGERINE • TANGERINE • TANGERINE • TANGERINE

Stockist Enquiries on headed notepaper to:

COMPUTER KIT LTD. (Principal Distributors in U.K.)

11/12 Paddington Green, London, W2, Tele: 01-723 5095

Telex: 262284 Ref. 1400 TRANSONICS

All orders pre-paid and official advertised here

to be forwarded DIRECTLY to

COMPUTER DEPT., 11/12 PADDINGTON GREEN, LONDON W2

SEND FOR
FREE BROCHURE

● Circle No. 347



**we've
made all
the pieces
fit!**

AMA's MPM*, together with its complementary data base manager MULTI-KISS**, provide the user with facilities previously unattainable on a micro computer.

A Multi-User Data Base

Multiple users may access or update a common data base simultaneously. True indexed sequential and direct access files are provided. Programs are written in Microsoft's M BASIC compiler and access of the data base is through callable routines.

Record Locking

Full provision is made for locking of index file or data file records. No other application language for MPM can provide this. The fool proof record locking method employed makes this AMA system truly multi-user.

A Transaction Log

All alterations made to the data base are recorded in a daily log file. Should a file be destroyed, a backup copy of the file may be updated with transactions from the appropriate log files.



AMA (Computing) Ltd., 1 Froghall Lane, Warrington, WA2 7JJ, Cheshire. Telephone Warrington (0925) 51885.

* Trademark of Digital Research Inc.
** Trademark of Tascos Corporation.

Please send me further information on the AMA MPM*/MULTI-KISS** System

Name

Company Address

PC 12/81

● Circle No. 348



in CROYDON

APPLE II HARDWARE

APPLE II SOFTWARE

APPLE II PERIPHERALS

APPLE II BESPOKE SOFTWARE

OPEN 9AM to 8PM 6 DAYS A WEEK

SUNDAY DEMONSTRATIONS
BY APPOINTMENT

IF WE DON'T HAVE IT WE'LL GET IT!

CALL OR PHONE FOR PRICES & DETAILS

SYMBIOTIC COMPUTER SYSTEMS

85/87 STATION RD, WEST CROYDON
TEL: 01-680 8606

● Circle No. 349

**Thinking about
a micro computer?**

If it's for business, then you'll need a computer that's designed as a real business machine — the Prince!

Not a plaything for the enthusiast, but a system that's proven, good value for money and a secure investment.

The Prince is a micro computer, which enables you to learn on a minimum investment and link up to larger computer systems later.

Sales, purchase, nominal ledgers plus payroll, order entry, stock control, word processing, graphics — all ready made for a computer user.

But in reality the Prince user buys a lot more.

As a manufacturer, DIGICO Computers provide computer systems that cope with growth, provide a seven year maintenance guarantee on it's whole range of systems* and enable users to keep abreast of technology with the security of 15 years design and manufacturing experience behind them.

Thinking about computers — then start right and stay right with a DIGICO Prince.

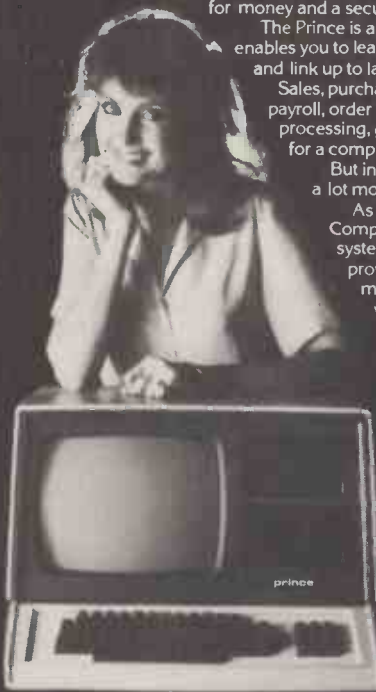

**DIGICO Computers
MICRO DIVISION**
Arena House
46 Broadway
Letchworth
Herts SG6 3BX
Tel: (04626) 78172

*Providing there is a maintenance contract continuously from new.

● Circle No. 350

SOFTWARE.. SOFT TREATMENT

Modern technology is solving all kinds of problems within commerce and industry — but there is one problem that has remained unsolved — until now.

The distribution and handling of the sophisticated equipment involved.

Carrycare is the distribution service designed especially for valuable and fragile products.

Over the years, we have handled the finest glassware and china — with the utmost care.

More recently, the Carrycare service has been extended to cover electronic, audio, optical and white goods, all requiring special treatment.

With staff trained to handle delicate and easily-damaged products. With specialist packaging and equipment. And the backing of one of the UK's largest transport and distribution organisations.

All geared to offer a highly professional, fast, smooth-running operation that makes good, sound economic sense.

But Carrycare doesn't stop there.

We can offer a total service from stockholding and accounting, order processing and sales support to security and insurance.

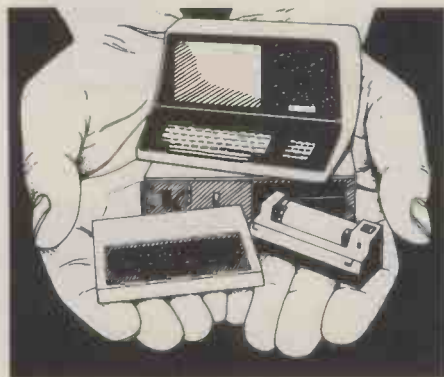

Carrycare could have been designed for the computer industry. No one is better-equipped to handle your products. No one has the same high degree of expertise or know-how. Nor the level of dedication.



Contact us today and find out how the Carrycare treatment could solve all your distribution and handling problems

at a stroke. For further information write to or telephone Brian Cooper or David Norris.

Carrycare

A little extra care goes a long way.

The specialist distribution service for fragile goods.

Carrycare 268/292 Silverdale Road, Newcastle-under-Lyme, Staffs. Telephone: Newcastle (0782) 625136

● Circle No. 351

TRS-80 I, II & III

Superior Disk Software

EXTENDED BASIC (Models II & III) will dramatically increase your programming productivity! EXTENDED BASIC requires no user memory and permanently patches your Basic interpreter to give you single keystroke abbreviations for common commands, the most powerful cross reference utility on the market, an enhanced renumber command allowing relocation and duplication of code, a keyword and string location/replacement facility, a utility for dumping the current values/contents of variables and a text compression function to reduce the size of any program to an absolute minimum — and more!

£94.50/£67.50 Model II/III

THE SPOOLER (Models I, II & III) is our workhorse. The highest performance print spooler available THE SPOOLER makes typical commercial applications run up to *twice* as fast by allowing your printer to fully overlap both disk and processor functions. Beware of other inferior spoolers which spool slowly to disk and stop every time the disk is accessed! Model II version requires no user memory.

£45.00/£49 Models I/II, III.

DOS PLUS (Models I, III & V.G.) is faster, easier to use, more compact and more efficient than TRSDOS, NEWDOS +, VTOS or LDOS and yet features all of their major commands plus some innovative ones of its own, is super-reliable and costs less — what more can we say!

£49.50

NEW: SORTDIR — sorts your directory, DOTWO — include keyboard input in your DO file, TRAKCESS by Roxton Baker — simply the best Model I ZAP + VARKEEP — keep variables between programs, TASMOM — the best monitor available + superb uk written MODEL II APPLICATIONS — payroll, inventory — parts explosion, accounts, letter writer + mailing, all with individual tailoring available by the author.

SPECIAL: Ribbons for LP III/V only £7.25 each (inclusive)
Model I double density kit (includes DOSPLUS) £106.00

Prices exclude VAT but include postage & packing.
For a detailed catalogue (disk software only) send 50p to:

SYSTEM SOFT

49 Dunvegan Drive, Rise Park, Nottingham NG5 5DX.
Tel: (0602) 275559

● Circle No. 352

The ASP 3500...

- HIGH SPEED 180 CPS
- 225 COLUMN WIDTH
- TRACTOR FEED OR CUT SHEET INSERTER
- 9*9 DOT MATRIX
- FULL GRAPHICS
- TRUE DESCENDERS
- VARIABLE PRINT
- SELF TEST
- 2 K BUFFER
- PARALLEL OR SERIAL INTERFACE AS STANDARD
- PLUS MANY MORE FEATURES

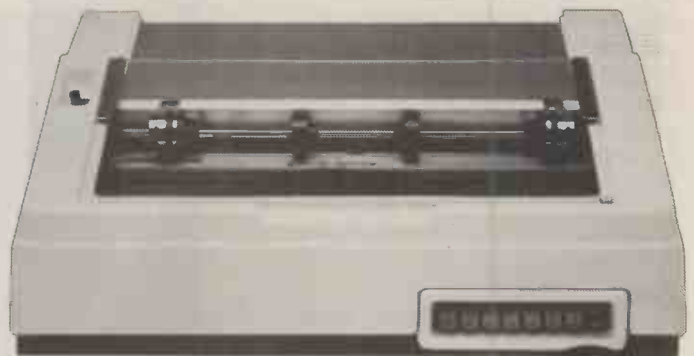

...the new **£850 PLUS VAT**
matrix printer
from

MITSUI

Contact: Kelvin Gregory
Mitsui Computers
Oakcroft Road,
Chessington, Surrey.

Telephone: 01-397 5111

Dealer enquiries welcome

● Circle No. 354

DEALERS

THE WESTFARTHING SMALL BUSINESS SYSTEM

is almost the only integrated accounting and invoicing system specially written for the 1 to 10-man business and professional practice. It is user-modifiable (a main selling point), has been on sale for over a year, and no user has reported a bug over the last few months. The retail price is £500.

The program is written for the Apple, and versions are being prepared for Superbrain, Sharp, Tandy and sorceror machines.

Applications are invited for exclusive rights to market the system:

- (1) for a specific micro, other than the above makes
- (2) for Apple or other computers in a foreign country
-no need to re-apply if you are already in touch with us-
In each case the financial outlay involved would be around £2,000.

Also (3) we welcome more U.K. dealers for the Apple version. No further payment than the kit charge is required before a sale is made.

An approval kit, consisting of demo disc, manual and sales literature costs £20 + VAT.



Westfarthing
Computer Services Ltd.
21 Wendron St. Helston. Cornwall.
Tel: Helston [03265] 4098.

● Circle No. 353

INDEPENDENT COMPUTER ENGINEERING LTD

APPLE AND S100 USERS: A 5¼" WINCHESTER DISK SUBSYSTEM

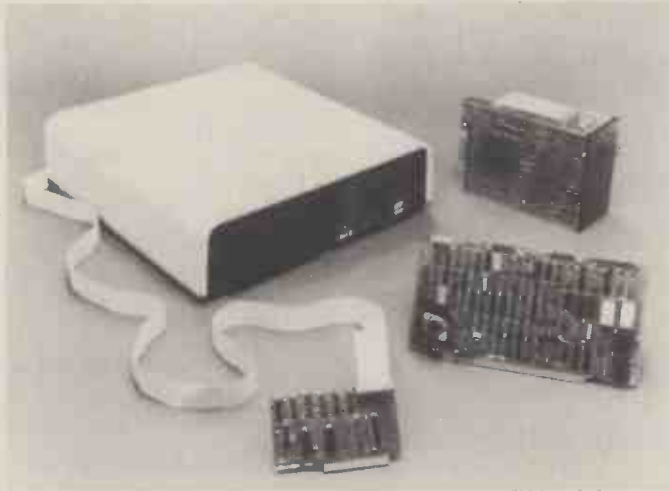

- ★ Up to 12.6 Mbyte formatted (256 byte sectors) capacity per drive
- ★ Optimised seek times (drive has on board microprocessor)
- ★ Cabinet plus power supply supports 2 Winchester drives or mix of 5¼" floppy plus Winchester
- ★ Drives available separately
- ★ Subsystem includes: controller, cables, drive, cabinet and software to support your system

Prices from: £1,560 (OEM) for complete subsystem

COMPLETE S100 BUS COMPUTER SYSTEM (Z80, 64K, 1 x 5¼" MINI FLOPPY, 1 x 5¼" WINCHESTER, 6.3 MBYTE FORMATTED) **£3,240**

CROMEMCO SYSTEMS & SOFTWARE:
CP/M 2.2 **£150**
MP/M 1.1 **£350**

EPSON: MX80 **£395**
MX80 F/T PLUS HIGH RES GRAPHICS **£455**
NEW: MX100 — 15" CARRIAGE PLUS HIGH RES. GRAPHICS **£575**

CALIFORNIA COMPUTER SYSTEMS:
S100 BOARDS & SYSTEMS (64K DYNAMIC RAM, BANK SELECT) **£360**

TELEVIDEO:
910, 920, 950 FROM **£425**
WORDSTAR/CUSTOMISING OPTIONS

END USER & OEM ENQUIRIES TO: ASHFORD (STD 07842) 47171 OR 47271

INDEPENDENT COMPUTER ENGINEERING LIMITED,

16/18 LITTLETON ROAD, ASHFORD, MIDDLESEX TW15 1UQ.

TEL: ASHFORD (STD 07842) 47271

TELEX: 8952042

(all prices exclude VAT)

COMPUTER SOLUTIONS TO BUSINESS PROBLEMS — SOFTWARE PACKAGES / HARDWARE MAINTENANCE / HARDWARE CONFIGURATION & DESIGN

BUSS STOP

ALL PRICES INCLUDE VAT

**BUSS
STOP**

CASH AND CARRY PRICES ON

COMMODORE

8032 32K WITH 80 COL SCREEN	£875.00
8050 DUAL DISK DRIVE, 950K	£875.00
4032 32K WITH 40 COL SCREEN	£690.00
4040 DUAL DISK DRIVE, 340K	£690.00
4022 DOT MATRIX PRINTER	£399.00
4016 16K WITH 40 COL SCREW	£478.00
8026 DAISYWHEEL PRINTER WITH KEYBOARD	£1006.00
8027 DAISYWHEEL PRINTER WITHOUT KEYBOARD	£860.00
8024 132 COL DOT MATRIX PRINTER	£1173.00

APPLE

APPLE 48K VIDEO OUTPUT COMPUTER	£784.00
DISK DRIVE WITH CONTROLLER	£384.00
DISK DRIVE WITHOUT CONTROLLER	£301.00

VIDEO GENIE

EG3003 VIDEO GENIE 16K COMPUTER	£387.00
EG3003 VIDEO GENIE 32K COMPUTER	£350.00
EG3013 EXPANSION BOX WITHOUT RS232	£205.00
EG3013 EXPANSION BOX WITH RS232	£238.00
EG3015 16K MEMORY	£105.00
EG3015 32K MEMORY	£148.00

FULL RANGE OF
SOFTWARE AVAILABLE!

☆ NOW IN STOCK ☆

VIC 20 £189.00

FULL RANGE OF ACCESSORIES AND
PERIPHERALS AVAILABLE.



255a ST ALBANS ROAD,
WATFORD, HERTS.
TEL: (0923) 32006.

CREDIT CHARGE
MAIL ORDER
24HR ANSWERPHONE

58 HIGH STREET,
NEWPORT PAGNELL, BUCKS.
TEL: (0908) 610625



GATE MICROSYSTEMS LIMITED

MICROCOMPUTER SALES + SUPPORT NOW IN DUNDEE + GLASGOW



Announce:—

THE MICROSOFT Z80 SOFTCARD FOR YOUR APPLE II PLUS

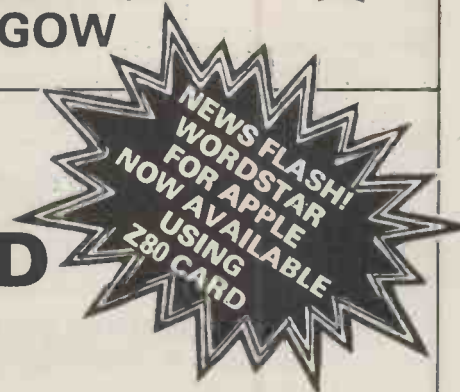

* Z80 Softcard is a circuit board with a Microprocessor and I/O Circuitry which plugs into any slot (except 0 in your APPLE).

* Z80 Softcard allows you to run CP/M, CP/M based languages and CP/M application programs on your APPLE.

* Z80 Softcard enables you to switch your APPLE back and forth from 6502 processing to Z80 processing via a single instruction.

* Z80 Softcard gives you Microsoft Basic 5.0 on your APPLE.

PRICE **£200.00** EX VAT

GATE MICROSYSTEMS LTD
THE NETHERGATE CENTRE
66, NETHERGATE, DUNDEE DD1 4ER (0382) 28194

GATE MICROSYSTEMS LTD
ABBAY HOUSE, 10 BOTHWELL STREET
GLASGOW G2 6NU 041-221-9372

CHROMASONIC electronics

DEPT P.C., 48 JUNCTION ROAD, ARCHWAY, LONDON N19 5RD

100 yds FROM ARCHWAY STATION & 9 BUS ROUTES

TELEPHONE 01-263 9493 263 9495

YOUR SOUNDEST CONNECTION IN THE WORLD OF COMPUTERS

PET

phone for prices



4016 16K RAM
4032 32K RAM
4040 Dual Drive Disk
The new PET printer.
4022 80 column tracks feed.
3023 80 column friction feed.
C2N Cassette Unit.

For the business man we stock the 8000 range inc. 8032 and 8050 with daisy wheel printers coming soon.

PHONE FOR DETAILS OF OUR 'STARTER SYSTEM' AND 'WORD PROCESSING/BUSINESS SYSTEM'

UK101

DOWN IN PRICE

UK 101 Kit inc 8K memory £125
Ready Built inc 8K memory £175
Complete in case £199
4K Expansion 8 x 2114 £14
Memory Expansion Kit
8K £79.95
16K £106.95
Printer Interface £29.95
Sound generator plus
PIO kit £29.95
Cases £24.50

NEW

Chromasonic Sound Kit £24.95
Colour Kit £84.95

Inc. Demo Tape & Full Documentation. Send for details

V
I
C
2
0

VIDEO GENIE



£279 EG3003

Utilises Z80, 12K level II Basic, Integral Cassette Deck, UHF O/P, 16K RAM, all TRS80 features. Simply plugs into monitor or UHF TV. With V.U. Meter.

PARALLEL PRINTER INTERFACE INC. CABLE £33.00
CHROMASONICS PROGRAMABLE SOUND KIT £24.94
SOUND KIT (FITTING EXTRA) £7.00
LOWER CASE KIT (FITTING EXTRA) £27.50
COLOUR KIT (FITTING EXTRA) £34.95
EXPANSION BOX WITH/WITHOUT RS232 £215/ 185
16K/32K RAM CARD £94/ 129
NEW GENIE II NOW AVAILABLE £299.00

APPLE

APPLE II PLUS

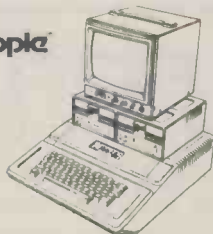

48K Machines £595
Disk Drive with Controller £349
Disk Drive without Controller £285
Colour Card £69
Graphics Tablet P.O.A.

ACCESSORY CARDS, SOFTWARE ALL AVAILABLE - PHONE FOR DETAILS

PRINTERS



EPSON MX80 £359
Dot-matrix printer with Pet graphics interface. Centronics parallel and serial. Pet and Apple compatible. True bidirectional, 80 cps.

EPSON MX80 FT/ 1 £399
Dual single sheet friction and tractor, 9 wire head, true descenders.

INTERFACES AND CABLES for Apple II, Pet, TRS80, RS232, UK101, Sharp Superboard all available.

EPSON MX80 FT/ 2 £449
An FT/1 with high resolution graphics.

EPSON MX70 £259
Tractor feed, 7 wire head high resolution graphics.

SEIKOSHA GP80A £199
Dot matrix 5 x 7, 80 columns 30 cps. graphics, double width characters.

JUST PHONE FOR FURTHER DETAILS

MONITORS

GREEN MONITOR 9" £98.00
MONI 9" (illust) B&W £82.00
Hitachi professional monitors
9" Black & White £99.95
12" Black & White £149.00



VIC 20

Colours

24 total. 8 for characters, 8 for border, 16 for screen mixed as you wish. Basic colours on program keys are black, white, red, blue, light blue, green, yellow, and purple.

Sound

3 Tone Generator for music
"White Noise" Generator for language and sound effects.
Each Generator gives 3 octaves.
Reproduction is through TV speaker.

Character/ Line Display

22 Characters by 23 lines
64 ASCII characters, pet-type graphics character set.

Keyboard

DIN typewriter keyboard with 8 programmable function possibilities via 4 special function keys. Colours are directly addressable from the keyboard.

Peripherals/ Accessories

VIC Datacassette with special interface to guarantee high reliability read/write quality (PET/CBM compatible).

PRICE ONLY £165
CASSETTE DECK with 6 free programmes
ONLY £34.75



TANTEL

PRESTEL BY TANTEL

COMMUNICATION AT YOUR FINGER TIPS FOR BUSINESS & HOME. UP TO DATE INFO

180,000 pages of information on Travel, News, Investment, Holidays, Hotels Etc., Etc.

£170

TANTEL IS POST OFFICE APPROVED. SEND FOR DETAILS. DEMONSTRATION AVAILABLE AT OUR SHOWROOM



Please add VAT 15% to all prices. Postage on computers, printers and cassette decks charged at cost, all other items P&P 30p. Place your order using your Access or Barclaycard. (Min. tel order £5). Trade and export enquiries welcome.

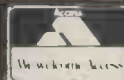

● Circle No. 359

WE'RE IN GREENWICH WHERE ARE YOU?

SUPERBRAIN

ALPHATRONIC

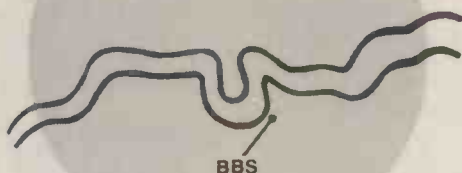

If you're an hour from the Blackwall Tunnel you're an hour from us.
We supply Superbrain and Alphatronic business systems, a range of dot matrix and daisywheel printer, plus

Software

CP/M Packages for
Payroll/Stock & Invoicing/Integrated
Accounting/Word Processing/
Accountants/Solicitors/Insurance
Brokers/Financial Modelling/Data Base
New Systems can also be designed and
developed by experienced analysts

Services

All consumables are available ex-stock
diskettes/diskette cases/print wheels/
printer ribbons/labels/continuous
stationery/terminal and printer dust
covers
Maintenance of both hardware and
software
On-going support
A back-up bureau service

Call us now on 01-853 5455
BBS Limited, 14 Nelson Road, Greenwich, London SE10 9JB

● Circle No. 360

THE ITT 2020



£1950
+ **VAT**
£1950
+ **FREE**

48K ITT 2020 Microcomputer
2 Disc Drive
Disc Drive Controller
Epsom MX 80 F/T Printer
ITT 12" Monitor
Box of 10 Floppy discs
2000 sheets of paper
All leads with plugs fitted
Delivery U.K. Mainland

Wide range of business software

Ask for details

Eastern Micros

91 Widford Road, Chelmsford, Essex
Telephone: 0245-352829

Callers by appointment only

● Circle No. 361

SOFTWARE FOR CP/M®

HIGH QUALITY SOFTWARE - WITH HIGH QUALITY SERVICE

★ NOTE NEW PRICES ON MICROPRO AND MICROSOFT PRODUCTS - Dealer enquiries welcome--good discounts for quantity orders let us supply your full range of software

WORDSTAR - Professional word processing software. On-screen formatting, wordwrap, pagination, line and character count on view. Micro-justification on daisy-wheel printer. Search and replace. Block/paragraph manipulation. External file read/write. Background printing during editing etc.	£250	MICROSOFT FORTRAN COMPILER	£205
MAIL-MERGE - Powerful Wordstar enhancement for file merging and document personalisation.	£65	MICROSOFT COBOL	£310
DATASTAR - Screen orientated system for Data Entry, Retrieval and Updating.	£175	MAGSAM - Versatile easy to use Keyed File Management System for Microsoft Basic or CBASIC.	£130
SUPERSORT - Sort, merge and selection program.	£125	CIS - COBOL - ANSI' 74 implementation to full level 1 standard. Supports random, indexed and sequential files, features for conversational working, screen control, interactive debugging, program segmentation etc.	£425
CONFIGURABLE BUSINESS SYSTEM (CBS) - Unique information management system with user definable files, powerful report generator, menu-driven for ease of use. No programming experience necessary!	£225	FORMS-2 - Automatic COBOL code generator for screen formats.	£100
ACCOUNTING PACKAGES by Median - Tec: PAYROLL, SALES, PURCHASE, NOMINAL Specially developed by UK software house to exacting specifications. Written in Microsoft Basic each package may be customised by end user, all are widely used. Ledgers are open item. Payroll caters for weekly and monthly pay.	£500 each	PASCAL-2	£235
PROJECT COST CONTROL/JOB ACCOUNTING - A comprehensive set of programs to monitor budgets, account for expenditure and project completion etc. Ideally suited for contractors. Written in CBASIC-2.	£150	STRUCTURED BASIC - Relocatable compiler	£160
STATISTICS PACKAGE - Over 25 routines including Regression & ANOVA	£100	CBASIC-2 - Extended Disk Basic pseudo compiler and run-time interpreter.	£75
MATHS PACKAGE - Over 40 easily used routines.	£100	SELECTOR III - C2 - Information management system written in CBASIC-2	£185
IBM - CP/M COMPATIBILITY - Powerful utility to transfer data to/from IBM machines in standard disk format.	£110	SELECTOR IV - Upward compatible version of III with enhanced reporting.	£300
MICROSOFT BASIC INTERPRETER	£155	BSTAM - Telecomms facility for exchanging files between CP/M computers.	£75
MICROSOFT BASIC COMPILER	£195	ASCAM - Facility for communicating with other computers.	£95
		TRANSFER - CP/M to CP/M file exchange - telecomms source code	£125
		MACRO 80 - Macro Assembler	£99
		CP/M 2.2 - Standard Version 8" Single Density.	£99

Please contact us for availability of other products
All orders must be PREPAID. Add £1 per Item P & P (Minimum £2.00) and VAT
CP/M is trade mark of Digital Research



TELESYSTEMS LTD

P.O. Box 12, GREAT MISSENDEN, BUCKS, HP16 9DD

Telephone (02406) 5314



● Circle No. 362

THE TRANSTEC 1200 VIDEO MONITOR.



**DEALERS
REQUIRED
NATIONWIDE**

JUST £99 COMPLETE.*

At last, a top quality green screen 12" video monitor at a really competitive price.

The Transtec 1200 has a composite video input, compatible with all micro computers and the screen gives a crisp read-out of a full 80 columns.

The unit is housed in a durable plastic cabinet with controls neatly concealed behind a hinged front-access panel.

Why pay more? Send the coupon today for full specification or better still, call us direct in Bristol.

transtec

13A Small Street, Bristol W1.
TEL: (0272) 277462.

Send £115 (VAT and carriage incl.) for immediate delivery.

* Vat, postage and packing not included.

I like the Transtec 1200 price — send me more data — fast.

Name _____
Company _____
Address _____
Position _____
Tel: _____ 231

P.A.C. DEC

PRINTERS

Buy any of the below and get a free interface kit and word processor program for UK101 or Superboard.
 Base 2 800MST £250, Seikosha GP80A £199, Centronics 737 £365, OKI Microline 80 £295, OKI Microline 82A £399, OKI Microline 83A £699, Epson MX70T £259, Epson MX80T £359, Epson MX80F/T1 £399, Epson MX80F/T2 £449, Epson MX100 £575.



SHARP COMPUTERS



MZ80K
20K
£380.
36K £394.
48K £408.
PC1211 £82.

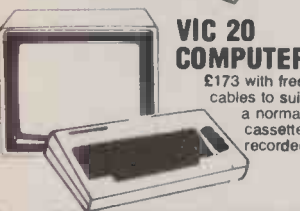

**VIC 20
COMPUTER**
£173 with free cables to suit a normal cassette recorder

SWANLEY ELECTRONICS

Dept PC, 32 Goldsel Rd, Swanley, Kent BR8 8EZ
Tel: Swanley (0322) 64851

Postage £3.50 on computers, £4.50 on printers and 45p on other orders.
Lists 27p post free. Please add VAT to all prices.
Official credit orders welcome.

OHIO SCIENTIFIC COMPUTERS

Superboard 3, POA. Power supply and modulator kit £11-95. Guard band kit £10. 4K extra RAM £10-80. 16K memory expansion complete kit £50, built £58. 32K memory expansion kit £74, built £82. Case £27. Cesmon £22-50. Wemon £19-95. Assembler/Editor tape £25. Word processor program £10. Centronics interface kit £10. 610 expansion board, POA. Cased minifloppy disc drive, POA. Cassette recorder £19. Colour adaptor board, built £45.

PET, ATOM, UK101 MEMORY REVOLUTION

Memory expansion boards 16K kit £50, built £58. 32K kit £74, built £82.

VIDEO GENIE £279

Expansion box without/with RS232 £179/£209. Disc drive £205. 16K/32K RAM board £93/£128. Colour kit £34-95. Parallel printer interface £32. Write for free software list.

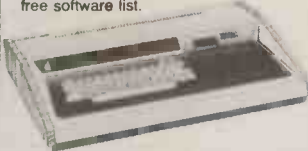

5V POWER KITS

Fully stabilised 5V computer and TTL power kits. Short circuit and over-voltage protection. 1.5A £7-83. 3A £12-17. 6A £20.

● Circle No. 364

Write off your Computer Supplies problem now.

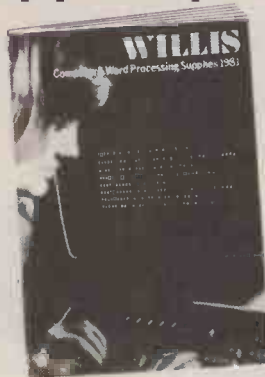

Flexible Disks
Digital Cassettes
Printwheels
Binders
Disk & Tape Storage
Magnetic Tape
Cartridges
Ribbons
Continuous Stationery
Filing Systems
Fire Resistant
Cabinets
Disk packs

Please send me your Catalogue.

Name _____
Company _____
Address _____

PC12/81

WILLIS

Computer Supplies
for people who know better

Post to: Willis Computer Supplies Limited, FREEPOST, PO Box 10, Southmill Road, Bishop's Stortford, Herts, CM23 1BR or Tel: Bishop's Stortford (0279) 506491.
Telex: 817425.

● Circle No. 365

SPECIAL PRICES FOR A LIMITED PERIOD ONLY

Video Genie EG3003 16K Computer	£280
Centronics 737-2 dot matrix printer.	
Interfaces for Apple and Video Genie	£345
Wordstar — For Apple	£170
The Mill 6809 Processor Board	£236
CP/M upgrade kit for Apple II:-	
Z-80 Softcard with CP/M, 16K Ram	
Card, & Videx 80 column U/L case board	£460

★ Tabs Software Stocked ★

Apple & Video Genie hardware and software, Anadex, Midas Computer Systems, Televideo terminals, accessories and computer books.

*Specialist software written.
*Hi-Fi retailers & allied trades stock control program now available.

AERCO GEMSOFT,

171 CHURCH ST. EAST,
WOKING, SURREY.

Tel: (04862) 22881

Sooner or later
you won't be able
to manage
without one.

Whether you spend your day producing sales forecasts controlling stock, running an accounts department or your own business you could be wasting your time — and your money — without an Apple Computer.

Apple Computer
Sales and Service

Find out how
Apple can help
you now at:



TRS-80 in Surrey

SPECIAL PRE-CHRISTMAS OFFERS AND NEW LINES

CENTRONICS P1 80 COL. THEMAL PRINTER £129 inc. VAT. Last list price £199.00

TRS-80 POCKET COMPUTER £89.00 inc. VAT. Normal price £119.00

VERBATIM DATALIFE 5 1/4 INCH DISCS, single or double density — still only £19.90 for ten inc. VAT

BUDGET MANAGEMENT PROGRAMME (16K level II) £14.95 normally £19.95 — ideal for your household or small business accounts

LINEPRINTER VII — Few left at pre-increase price of £199.00 inc. VAT. Normally £239.00

BACK IN STOCK! TANDY PRINTER INTERFACE CABLE — connects your printer direct to your CPU £44.95 each (Video Genie model also available)

PRINTER AND CASSETTE INTERFACE FOR POCKET COMPUTER £79.95. Normally £89.95 (Spare paper rolls and ribbons in stock)

NEW — NEW — NEW ANTI-GLARE FILTER for your Model I, II or III computer monitor — only £10.95

MODEL I SYSTEM DESK £99.95 normally £119.95 (callers only)

NEW — NEW — NEW TRS-80 COLOUR COMPUTER available in November — prices from £349.00

ATARI VIDEO GAMES COMPUTER now only £95.00 inc. VAT. 10% off retail prices of all cartridges!

OFFERS LIMITED TO EXISTING STOCKS ONLY

★★★ LOOKING FOR AN EPSON OR MICROLINE PRINTER? LET US QUOTE YOU! WE WILL DO OUR BEST TO BEAT ANY CURRENTLY ADVERTISED PRICE! ★★★

ALL PRICES INCLUDE VAT WHERE APPLICABLE

SURREY MICRO SYSTEMS LTD

53 WOODCOTE ROAD, WALLINGTON, SURREY TEL: 01-647 5636

Access and Barclaycard Holders may phone their orders — Post and Packing extra — add 5% to order value. Send s.a.e. for full software list.



**CRYSTAL ELECTRONICS
CC ELECTRONICS**

FOR YOUR SHARP MZ80K CP/M 2.21 (XTAL)

BASIC CP/M FACILITIES INCLUDE:

- Dynamic file management Fast assembler
- General purpose editor • Advanced debugging utility

YOUR SHARPCP/M 2.21 (XTAL) PACKAGE INCLUDES:

- Hardware modification (if fitted by a SHARP dealer does NOT break the guarantee)
- SHARP CP/M 2.21 (latest version) on disc
- XTAL Monitor and Operating system
- 7 Digital Research manuals
- 12 months guarantee and up-dates (on all our products)

CP/M 2.21 (XTAL) FROM £150 + VAT

Ask your SHARP dealer for further details or contact CRYSTAL ELECTRONICS

CP/M SOFTWARE HOUSES—XTAL CAN HELP YOU ESTABLISH YOUR SOFTWARE ON THE SHARP.

XTAL BASIC (SHARP)

Takes 5K less memory, has all the features of SHARP BASIC PLUS Multi dim strings, error trapping, logical operators, machine code monitor, more flexible peripheral handling, improved screen control, increased list control, auto run, if..then..else—and it doesn't stop there—it grows. You can extend the commands and functions at will—10K, 12K, 16K, BASIC?. SHARP to XTAL BASIC conversion program is included. **£40 plus VAT.**

Bi-directional serial board for your SHARP RS232 compatible 150 Baud to 2400 Baud adjustable. <5,6,7,8 Bit words, plugs into MZ80I/O **£99.50 plus VAT.** Includes software for bi-directional use in XTAL BASIC, software for using SHARP BASIC with serial printer and self-diagnostic software for testing Baud rate etc.

Members of Computer Retailers Association & Apple Dealers Association
Shop open 0930—1730 except Saturday & Sunday
40 Magdalene Road, Torquay, Devon, England. Tel: 0803 22699

Access and Barclaycard welcome



● Circle No. 368

SUPERSEM

PLYMOUTH



PHONE 0752
21256

FAST
DELIVERY

All your semiconductors at incredibly low, low prices.

MEMORIES	1-100	100 +
2114 450ns	90p	80p
2114 300ns	95p	85p
2114 200ns	£1.00	90p
4116 200ns	80p	70p

EPROMS	1-100	100 +
2716 450ns	£2.40	£1.95
2732 450ns	£4.50	£4.00

Please add VAT to all orders.
Free delivery in the U.K.

Please make cheques and postal orders payable to Supersem Plymouth.

To order or for component quotes write to:

Supersem Plymouth
Valley Road,
Plympton,
Plymouth PL7 3RF

● Circle No. 369

The Jarogate Tape Backup System
Discs are vulnerable . . .
GET 'EM TAPED - FAST



This new system provides a reliable and flexible backup facility, but with a breakthrough in data transfer speed. Yet it costs no more than other systems offering only half the performance.

It transfers data at 24k/bytes per second – backing up a 10M/byte hard disk in less than 20 minutes, including checking and verification. It has twice the capacity of most other units, too . . . up to 24M/bytes of data on one standard cartridge.

Standard S100 bus controller card gives full interface with your computer, plus the additional facilities of two RS232C serial channels and 10 programmable timers.

A full Jarogate software package is included, on 5" x 8" diskette. It allows data backup and recovery on a file-by-file basis, under the Digital Research MP/M or CP/M systems or Cromemco's CDOS system.

The cartridge unit is based on the well-established Kennedy 6450 system.

Also available – the Jarogate Z2-HMP, a high-performance multi-user, multiprocessor system for under £11,000.

JAROGATE

JAROGATE LIMITED
MICROPROCESSOR CONSULTANTS
67 Tulsemere Road, West Norwood, London SE27 9EH
Telephone: 01-670 3674

● Circle No. 370

WATFORD ELECTRONICS

33/35, CARDIFF ROAD, WATFORD, HERTS, ENGLAND

Tel Watford (0923) 40588. Telex: 8956095

MAIL ORDER CALLERS WELCOME

ALL DEVICES FULL SPEC. AND FULLY GUARANTEED. TERMS OF BUSINESS: CASH/CHEQUE/P.O.S. (OR ACCESS) WITH ORDER. GOVERNMENT AND EDUCATIONAL INSTITUTIONS OFFICIAL ORDERS ACCEPTED. TRADE AND EXPORT INQUIRIES WELCOME. (P&P ad 50p on all orders under £10.00).

VAT ALL PRICES ARE EXCLUSIVE OF VAT. PLEASE ADD 15% TO THE TOTAL COST INCLUDING P & P.

SHOP HOURS: 9.00am - 6.00pm MONDAY TO SATURDAY.

AMPLE FREE CAR PARKING SPACE AVAILABLE.

COMPUTER IC's	280 CTC 350 280A CTC 400 280DMA 999 280S10-1 £15 280AS10 £23 280 DART 725 280A DART 725 ZNA19CE 190 ZNA23E 195 ZNA24E 130 ZNA25E 350 ZNA26E 325 ZNA27E 625 ZNA28E 478 ZNA29E 210 ZNA30E 210 ZNI040E 775 74L00 68 74L30 50 74L47 380 74L75 145 74L85 210 74L121 165 74L123 325 74S132 138 74S138 240 74S18 210 74S185 158 74S194 360 74S201 350 74S241 540 74S282 850 74S287 210 74S470 325 74S471 620 74S472 1150 74L85 210 74S571 820 75150 140 75108 350 375 154 75188 65 75199 99 50 5322 6803 1360 75450 95 75451/2 70 75454 225 75491/2 70	7491 45 7492 30 7493 30 7494 34 7495 50 7496 45 7497 120 74100 85 74104 54 74105 15 74107 32 74109 35 74110 40 74111 55 74112 170 74116 88 74118 90 74119 90 74120 75 74121 30 74122 45 74123 50 74124 42 74126 40 74128 42 74132 48 74136 38 74141 70 74142 190 74143 250 74144 250 74145 70 74147 99 74148 75 47150 80 74151 45 74153 45 74154 75 74155 825 74156 75 74157 45 74159 99 74160 60 74161 80 74162 80 74163 84 74164 64 74165 62 74166 85 74167 85 74170 168 74172 290 74173 65 74174 72 74175 72 74176 55 74177 75 74178 75 74179 68 74180 68 74181 69 74182 75 74184 99 74185 99 74188 290 74190 70 74191 70 74192 70 74193 65 74194 75 74195 65 74196 65 74197 95 74198 99 74199 99 74200 70 74201 70 74202 70 74203 25 74204 25 74205 25 74206 28 74207 28 74208 16 74209 16 74210 20 74211 20 74212 20 74213 22 74214 22 74215 22 74216 22 74217 22 74218 22 74219 22 74220 22 74221 22 74222 22 74223 22 74224 22 74225 22 74226 22 74227 22 74228 22 74229 22 74230 22 74231 22 74232 22 74233 22 74234 22 74235 22 74236 22 74237 22 74238 22 74239 22 74240 22 74241 22 74242 22 74243 22 74244 22 74245 22 74246 22 74247 22 74248 22 74249 22 74250 22 74251 22 74252 22 74253 22 74254 22 74255 22 74256 22 74257 22 74258 22 74259 22 74260 22 74261 22 74262 22 74263 22 74264 22 74265 22 74266 22 74267 22 74268 22 74269 22 74270 22 74271 22 74272 22 74273 22 74274 22 74275 22 74276 22 74277 22 74278 22 74279 22 74280 22 74281 22 74282 22 74283 22 74284 22 74285 22 74286 22 74287 22 74288 22 74289 22 74290 22 74291 22 74292 22 74293 22 74294 22 74295 22 74296 22 74297 22 74298 22 74299 22 74300 22	LS04 15 LS06 15 LS08 15 LS09 15 LS10 15 LS11 15 LS12 15 LS13 30 LS14 48 LS15 15 LS16 15 LS17 15 LS18 15 LS19 15 LS20 15 LS21 15 LS22 15 LS23 18 LS24 18 LS25 18 LS26 18 LS27 15 LS28 20 LS29 18 LS30 18 LS31 18 LS32 15 LS33 18 LS34 18 LS35 16 LS36 16 LS37 16 LS38 16 LS39 16 LS40 16 LS41 16 LS42 35 LS43 40 LS44 40 LS45 40 LS46 60 LS47 60 LS48 60 LS49 60 LS50 60 LS51 15 LS52 15 LS53 15 LS54 15 LS55 30 LS56 150 LS57 25 LS58 25 LS59 25 LS60 25 LS61 25 LS62 25 LS63 25 LS64 25 LS65 25 LS66 25 LS67 25 LS68 25 LS69 25 LS70 25 LS71 25 LS72 25 LS73 25 LS74 25 LS75 25 LS76 20 LS77 20 LS78 24 LS79 24 LS80 24 LS81 24 LS82 24 LS83 50 LS84 50 LS85 50 LS86 50 LS87 50 LS88 50 LS89 50 LS90 35 LS91 80 LS92 36 LS93 36 LS94 36 LS95 36 LS96 120 LS97 43 LS100 30 LS112 30 LS113 40 LS114 14 LS115 14 LS116 14 LS117 14 LS118 14 LS119 14 LS120 14 LS121 45 LS122 45 LS123 55 LS124 105 LS125 30 LS126 30 LS127 30 LS128 30 LS129 30 LS130 30 LS131 30 LS132 45 LS133 35 LS134 35 LS135 35 LS136 28 LS137 35 LS138 35 LS139 38 LS140 38 LS141 38 LS142 38 LS143 38 LS144 38 LS145 38 LS146 38 LS147 38 LS148 38 LS149 38 LS150 38 LS151 38 LS152 38 LS153 38 LS154 38 LS155 38 LS156 38 LS157 38 LS158 38 LS159 38 LS160 41 LS161 41 LS162 41 LS163 41 LS164 41 LS165 41 LS166 41 LS167 41 LS168 41 LS169 41 LS170 41 LS171 41 LS172 41 LS173 41 LS174 41 LS175 41 LS176 41 LS177 41 LS178 41 LS179 41 LS180 41 LS181 41 LS182 41 LS183 41 LS184 41 LS185 41 LS186 41 LS187 41 LS188 41 LS189 41 LS190 41 LS191 41 LS192 41 LS193 41 LS194 41 LS195 41 LS196 41 LS197 41 LS198 41 LS199 41 LS200 41 LS201 41 LS202 41 LS203 41 LS204 41 LS205 41 LS206 41 LS207 41 LS208 41 LS209 41 LS210 41 LS211 41 LS212 41 LS213 41 LS214 41 LS215 41 LS216 41 LS217 41 LS218 41 LS219 41 LS220 41 LS221 41 LS222 41 LS223 41 LS224 41 LS225 41 LS226 41 LS227 41 LS228 41 LS229 41 LS230 41 LS231 41 LS232 41 LS233 41 LS234 41 LS235 41 LS236 41 LS237 41 LS238 41 LS239 41 LS240 41 LS241 41 LS242 41 LS243 41 LS244 41 LS245 41 LS246 41 LS247 41 LS248 41 LS249 41 LS250 41 LS251 41 LS252 41 LS253 41 LS254 41 LS255 41 LS256 41 LS257 41 LS258 41 LS259 41 LS260 41 LS261 41 LS262 41 LS263 41 LS264 41 LS265 41 LS266 41 LS267 41 LS268 41 LS269 41 LS270 41 LS271 41 LS272 41 LS273 41 LS274 41 LS275 41 LS276 41 LS277 41 LS278 41 LS279 41 LS280 41	LS295 215 LS298 130 LS299 420 LS300 157 LS302 175 LS320 270 LS323 270 LS324 200 LS325 320 LS326 320 LS327 315 LS347 150 LS348 190 LS352 185 LS353 185 LS365 37 LS367 37 LS368 90 LS373 75 LS374 75 LS375 48 LS377 90 LS378 60 LS379 65 LS384 250 LS385 378 LS390 62 LS393 60 LS395 199 LS399 220 LS445 140 LS471 620 LS490 245 LS491 135 LS640 225 LS641 225 LS645 210 LS668 178 LS669 150 LS670 175 LS673 550 LS674 750 4507 40 4508 14 4510 68 4511 68 4512 75 4513 199 4514 195 4515 198 4516 75 4517 415 4518 42 4519 29 4520 66 4521 200 4522 125 4526 95 4527 115 4528 80 4529 150 4530 90 4531 130 4532 110 4534 500 4535 295 4538 115 4539 115 4541 140 4542 135 4543 150 4549 395 4553 299 4554 190 4555 50 4556 55 4557 320 4558 120 4559 395 4560 190 4561 104 4562 495 4566 175 4568 250 4569 175 4572 36 4580 460 4581 250 4582 99 4583 99 4584 48 4585 99 4586 99 4587 330 4588 290 4589 595 40097 88 40100 215 40101 130 40102 180 40103 175 40104 95 40105 115 40106 75 40107 60 40108 450 40109 100 40110 300 40114 240	4071 20 4072 20 4073 20 4075 20 4076 60 4077 26 4078 26 4081 26 4082 21 4088 65 4089 140 4093 43 4094 168 4095 90 4096 90 4097 320 4098 88 4099 95 4100 95 4101 99 4102 99 4103 99 4104 99 4105 105 4106 105 4107 99 4108 99 4109 99 4110 99 4111 99 4112 99 4113 99 4114 99 4115 99 4116 99 4117 99 4118 99 4119 99 4120 99 4121 99 4122 99 4123 99 4124 99 4125 99 4126 99 4127 99 4128 99 4129 99 4130 99 4131 99 4132 99 4133 99 4134 99 4135 99 4136 99 4137 99 4138 99 4139 99 4140 99 4141 99 4142 99 4143 99 4144 99 4145 99 4146 99 4147 99 4148 99 4149 99 4150 99 4151 99 4152 99 4153 99 4154 99 4155 99 4156 99 4157 99 4158 99 4159 99 4160 99 4161 99 4162 99 4163 99 4164 99 4165 99 4166 99 4167 99 4168 99 4169 99 4170 99 4171 99 4172 99 4173 99 4174 99 4175 99 4176 99 4177 99 4178 99 4179 99 4180 99 4181 99 4182 99 4183 99 4184 99 4185 99 4186 99 4187 99 4188 99 4189 99 4190 99 4191 99 4192 99 4193 99 4194 99 4195 99 4196 99 4197 99 4198 99 4199 99 4200 99 4201 99 4202 99 4203 99 4204 99 4205 99 4206 99 4207 99 4208 99 4209 99 4210 99 4211 99 4212 99 4213 99 4214 99 4215 99 4216 99 4217 99 4218 99 4219 99 4220 99 4221 99 4222 99 4223 99 4224 99 4225 99 4226 99 4227 99 4228 99 4229 99 4230 99 4231 99 4232 99 4233 99 4234 99 4235 99 4236 99 4237 99 4238 99 4239 99 4240 99 4241 99 4242 99 4243 99 4244 99 4245 99 4246 99 4247 99 4248 99 4249 99 4250 99 4251 99 4252 99 4253 99 4254 99 4255 99 4256 99 4257 99 4258 99 4259 99 4260 99 4261 99 4262 99 4263 99 4264 99 4265 99 4266 99 4267 99 4268 99 4269 99 4270 99 4271 99 4272 99 4273 99 4274 99 4275 99 4276 99 4277 99 4278 99 4279 99 4280 99 4281 99 4282 99 4283 99 4284 99 4285 99 4286 99 4287 99 4288 99 4289 99 4290 99 4291 99 4292 99 4293 99 4294 99 4295 99 4296 99 4297 99 4298 99 4299 99 4300 99
----------------------	---	--	---	--	--

VIC-20 Microcomputer

At last it is here, the long awaited Commodore's VIC 20 Microcomputer. Connects directly to any colour TV set. Sound reproduced through TV Speaker (Music, Language & other Sound effects). Has PET type Graphics. Standard PET Basic. Full size Keyboard. 5K memory expandable to 32K. Attractively cased.

Price: Only £165
Cassette Deck incl. Free 6 programme Cassette £34

SPECIAL OFFER

	1+	50+
2114L-450n	90p	85p
2114L-300n	99p	85p
2114L-200n	130p	115p
2708	200p	185p
2532	525p	499p
2716	230p	199p
2732	455p	390p
4027	240p	215p
4116	85p	70p
4334-3	325p	290p
6116-3	855p	805p
8216	120p	80p

WATFORD'S Ultimate MON Monitor IC.

A 4K Monitor Chip specially designed to produce the best from your Superboard Series I & II, Enhanced Superboard & UK 101. As reviewed by Dr. A. A. Berk in Practical Electronics, June 1981.

Price only £19.95 + 50p P&P.

Buy it with



EPSON
MX Series PRINTERS
Now available from stock at very competitive prices.

ETI/WATFORD'S MICRO EXPANSION SYSTEM

This versatile economical Expansion System as published Dec 1981 in ETI provides a Cheap but reliable Expansion possibility for most of the popular Microcomputers.

Send SAE for details.



SEIKOSHA GP80A
Unihammer Printer, gives normal and double width characters as well as dot resolution graphics 8" Tractor feed. Parallel Interface standard. £195

● MX80T 10" Tractor Feed, 9x9 matrix, 80 column Speed 80 CPS bi-directional Centronics Interface, Baudrate 110-9600 (RS232) £355

● MX80FT Has Friction & Tractor Feed plus all the MX80T's facilities. £395

● MX80FT2 Has high resolution Graphics option plus all the MX80T's facilities. £435

● MX100 132 Column plus all the facilities of MX80FT2. Value for money. £570

SOFTY-2

As reviewed on PE September 1981. The complete microprocessor development system for Engineers & Beginners. New powerful instruction. Accepts any 24 pin 5V single rail EPROM. Supplied fully built, tested & enclosed in a black ABS case. Price incl. encapsulated plug in power supply. £169

ACCESSORIES

- TEX EPROM ERASER. Erases up to 32 ICs in 15-30 min. £33
- Spare UV lamp bulbs £9
- 5V/5A PSU Ready built and tested £25
- Attractive Beige/Brown ABS CASE for Superboard/UK101 or Home Brew £26
- Extra 4K of RAM (8 off 2114L-300nS) £7.95
- Special Invaders for Superboard £6
- Full ASC11 coded keyboard type '756' £39
- NUMERIC Keypad (Readybuilt) £9
- 4 x 4 matrix keypad (read switch assembly) £4
- C12 Cassettes in Library Cases 40p
- 8 1/2" Fan fold paper (500 sheets) (no VAT) £6
- 9 1/2" Fan fold paper (500 sheets) (no VAT) £6
- Teleprinter Roll (no VAT) £3.50
- 15 1/2" Fan fold paper
- UHF Modulator 6MHZ 280p
- UHF Modulator 8MHZ 450p

The Currah Mini Digital Recorder is the fast and simple alternative to Disc £195

CRYSTALS	6144M Hz 240 65536M Hz 200 7.0M Hz 250 7.68M Hz 250 8.0M Hz 200 8.867237M 240 9.00M Hz 200 10.0M Hz 220 10.7M Hz 220 10.24M Hz 200 12.0M Hz 240 14.31818M 320 16.0M Hz 275 18.0M Hz 240 18.432M 240 19.968M Hz 325 24.0M Hz 200 26.69M 290 27.648M 330 27.145M 240 38.6667M 290 48.0M Hz 270 100.0M Hz 375 116.0M Hz 300
-----------------	---

'D' CONNECTORS (Cannon type)	Plugs	Sockets	Covers plastic
9 way	55p	125p	145p
15 way	135p	195p	150p
25 way	170p	250p	130p
37 way	290p	398p	185p
25 WAY 'D'	18" long single end Male	520	
CONNECTOR	18" long single end Female	525	
	36" long double ended M/M	1020	
Jumper Lead	36" long double ended F/F	1010	
Cable Assembly	36" long double ended M/F	1000	
JUMPER LEADS (Ribbon Cable Assembly)	Single ended) DIP	14 pin 145p	16 pin 165p;
	24" length Cable	24 pin 240p	40 pin 380p.
Double ended	6" 14 pin	16 pin 24p	24 pin 40p
	8" 185p	30 pin 300p	465p
DIP	12" 198p	21 pin 315p	490p
	24" 210p	23 pin 345p	540p
	36" 230p	25 pin 375p	595p

DIL PLUGS (Headers)	14 pin 44
	16 pin 49
	24 pin 88
	40 pin 255

Ribbon Cable	14, 10, 12, 14, 16, 18, 20 pin
10 way	22p
20 way	40p

DIL SOCKETS (TEXAS)	Low profile	Wire wrap
8 pin	8p	25p
14 pin	10p	42p
16 pin	16p	52p
18 pin	22p	60p
20 pin	25p	70p
24 pin	25p	70p
28 pin	28p	80p
36 pin	—	105p
40 pin	3	

The model of good business.

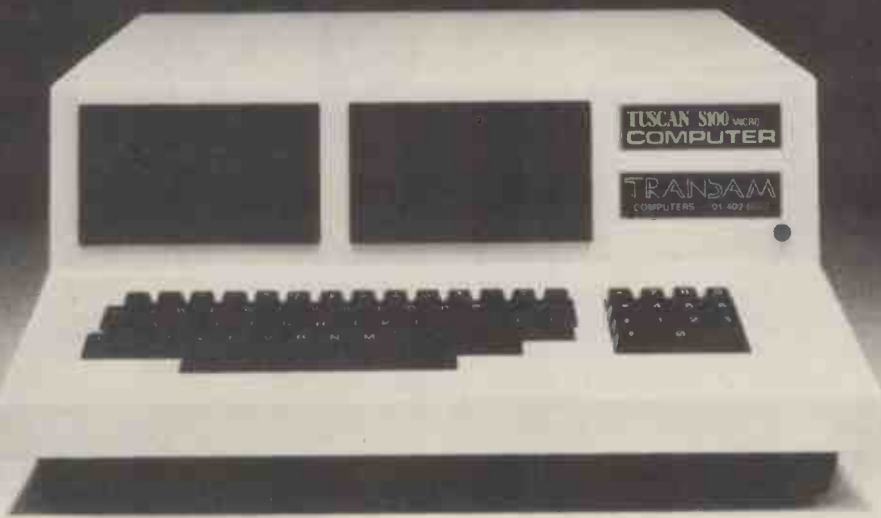

Tuscan – the all-British microcomputer

With a proven record of steady development behind it, the Tuscan S100 now goes a step forward, solving the problem of effective backup storage.

The Tuscan S100, Britain's first S100 computer on a single board, is now available with designed-in mini-Winchester drive for better performance, shorter access time and higher transfer rate. All this from Britain's own home-grown micro manufacturer.

Systems with printer, screen and CP/M start at £2125 with twin floppies, and at £3625 with one floppy and one 5-meg. mini-Winchester.

SOFTWARE. Business accounts packages start at £800 when purchased with the Tuscan system. Word processing packages start at £315; Database packages start at £100.

HARDWARE. Flexibility is the key feature of all Tuscan systems. A choice of storage capacity, video format and graphics is available. The Tuscan S100 can read and write in sixteen different disk formats, with a choice of 5¼" or 8" drives.

SUPPORT. The Tuscan S100, designed and built in Britain, is backed by Transam's substantial experience in electronics plus a dedicated hardware and software team. National third party maintenance is available at ten per cent of hardware costs.

BUSINESS SYSTEM DEALERS. Business Equipment Centre, 10 Edge Lane, Liverpool. Tel: 263 5783. Contact: Rod Crofts.
Purley Computers, 21 Bartholomew Street, Newbury, Berkshire. Tel: 41784. Contact: Ron Smith.

FURTHER INFORMATION. Two new catalogues covering "systems and peripherals" and "CP/M Software" are available, giving details of our systems and services. Call or write for yours.



TRANSAM

TRANSAM COMPONENTS LIMITED
59/61 THEOBALD'S ROAD, LONDON WC1
Tel: 01-405 5240/2113. Telex: 24224 (Ref. 1422) ● Circle No. 374

THE ATOM DEALER LIST

Computer stores are stocking Atoms - there's a list below. If there isn't one near you, fill in the coupon and we'll rush an Atom to you within 28 days.

Granite Chips Ltd. Aberdeen 22863. Inismor Holdings, Ayr 58602. Micro Style, Bath 334659. Broadway Elect, Bedford 213639. Micro-C, Birmingham 021-233-1105. Owl Computers, Bishops Stortford 52682. Microcentre, Bognor Regis 827779. Eltec Services, Bradford 491372. Gamer, Brighton 698424. Electronic Information Systems, Bristol 428165, Micro-C, Bristol 0272-650501. Cambridge Comp Store, Cambridge 65334. Rhombus, Cambridge 312953. Cardiff Micros, Cardiff 373072. Bellard Elect. Chester 380123. Vixon Computer Systems, Ciethorpes 58561. Customised Electronics Ltd., Cleveland 247727. Emprise, Colchester 865926. Ibek Systems Coventry. Lendac Data Systems, Dublin 37052. Silicon Centre, Edinburgh 332 5277. Highland Microcomputer, Forres 73505. H.C.C.S. Associates, Gateshead 821924. Mikrotronic, Germany 05 31 72 223. Esco Computing, Glasgow 204 1811. Computer Shack Ltd., Gloucester 584343. Control Universal, Harlow 31604. Unitron Elect, Haslington. Castle Elect., Hastings 437875. Currys Micro Systems, High Wycombe 36431. Northern Micro, Huddersfield 892062. Customised Electronics, Leeds 792332. Micro-C, Leeds 446601. D.A. Computers, Leicester 549407. Micro-C, Leicester 546224, Microdigital, Liverpool 236 0707. Barrie Elect, EC3 488 3316. Eurocalc, London 729 4555-9. Group 70, E18 352 7333. Microage, North London 959 7119. Ragnorak Electronic Systems, E2 981 2748. Sinclair Equip. Int. (Export), W1 235 9649. OFF Records, SW12 674 1205. Technomatic, NW10 7230233. Micro-C, Luton 425079. Micro-C, Ace Business Comp, Maidstone 677947, Manchester 834-0144. NSC Comp Shops, Manchester, 832 2269. Customised Electronics, Middlesborough 247727. Compshop, New Barnet 441 2922. Micro-C, New Malden 949 2091. Newbear Computing Store, Newbury 30505. H.C.C.S., Newcastle 821924. Newcastle Comp Services, Newcastle 761158. Anglia Comp Centre, Norwich 29652. Leasalink Viewdata, Nottingham 396976. Micro-C, Nottingham 412455. J.A.D. International Services, Plymouth 62616. R.D.S. Electrical, Portsmouth 812478. Computers for All, Romford 60725. Intelligent Artifacts, Royston Arrington 689. Owl Computers, Sawbridgeworth 723848. Computer Facilities, Scunthorpe 63167. Datron Micro Centre, Sheffield 585 490. Superior Systems, Sheffield 755005. Micro-C, Southampton 29676. Q-TEC Systems, Stevenage 65385. 3D Computers, Surbiton (01) 337 4317. Computer Supplies, Swansea 290047. Abacus Micro Comp., Tonbridge Paddock Wood 3861. Bellard Electronics Ltd., Upton 380123. Northern Comp, Warrington 601683. Compass Design, Wigan Standish 426252. Datex Micros, Worthing 39290.

SEE OUR ADVERTISEMENT ON PAGE 115



THE ZX81 POCKET BOOK

Also suitable for ZX80 with 8K ROM

- ADVENTURE
- City of Alzan
- Create your own
- TUNNELS & TROLLS
BUCKET CATCHING
- JAWS
BECOME AN ARTIST
- PRO-AM GOLF
PUTTER
ETCH-A-SKETCH
FRUIT MACHINE
With hold
DIGITAL CLOCK
DICE ROLLING
plus 20 others

110 PAGE
BOOK

5.95

CASSETTE
& BOOK

10.00

* require 16K RAM

PLUS Hints & tips on programming
Reference Sections



The ZX80 Pocket Book still
available, prices as above.

ATOM BUSINESS

Suitable for the expanded Atom with floating point ROM

Each section contains:

- Management Summary
- Operating Instructions
- Program notes
- Source listing

ADDLIST
LABEL PRODUCTION
LEASE OR BUY DCF
METRIC CONVERSION
STANDARD
DEVIATION
BUDGET FACTORING

SALES GRAPH
SALES RECORDS
NOMINAL LEDGER
QUEUEING
SIMULATION
EXPENSE CLAIMS

110 Page
Book

6.95

Cassette
& Book

15.57

PHIPPS ASSOCIATES

3 DOWNS AVENUE EPSOM Surrey KT18 5HG
Tel: Epsom (03727) 21215 quoting your credit
card reference. 24 Hour phone service. Air Mail
delivery in Europe add 50p, air mail elsewhere
add £1.50 per book. Prices shown above include
UK postage and VAT on cassettes

● Circle No. 375

● Circle No. 376

ADVANCED BUSINESS COMPUTERS

FANTASTIC FREE OFFER!!

VIC COMPUTER OR APPLE COMPUTERS

TANTEL ADAPTOR

with every complete business system bought or leased
(Closing date 31st. Jan 82)

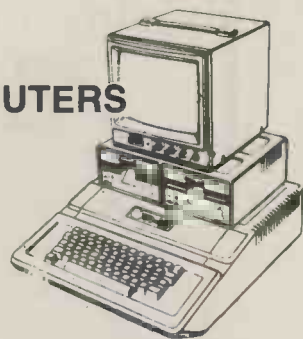

48K Apple II Plus
£695

COMMODORE PETS

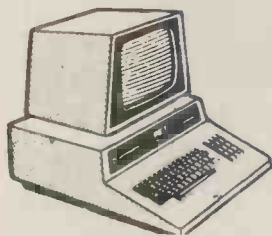

40 Col & 80 Col
Pets in stock
Phone for prices!

OLYMPIA SCRIPTA

DAISYWHEEL



KSR £945.00
RO £775.00

NEW
★
NEW



The Apple III

128K Business System
FROM £2,695

N
O
W
I
N
S
T
O
C
K

QUME SPRINT

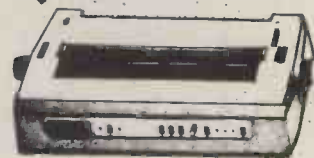

From £1,800



CIFER BRITISH COMPUTER SYSTEM

FROM ONLY £2,357 inc CP/M

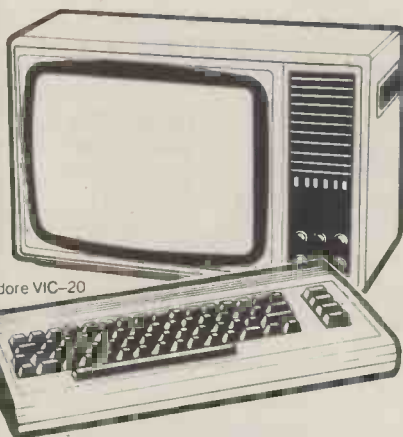

Commodore VIC-20

Starter £189.95 inc VAT

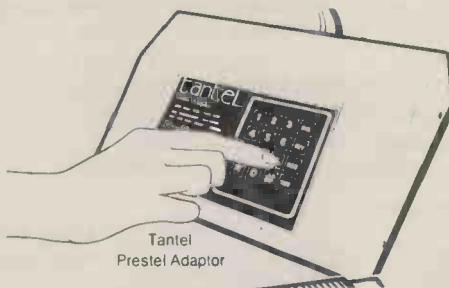

Tanel
Prestel Adaptor

Only £170

● Circle No. 377

Make the right choice:

Consult our **Systems Analyst**
Programmers
Accountant
Engineer

OUR SALES AND SERVICE ARE SECOND TO NONE
AND WE WON'T BE BEATEN ON PRICES!!

Always phone us for
latest prices!!

LEASE A COMPLETE
BUSINESS SYSTEM FROM
£8.75 PER WEEK

All prices quoted ex-VAT
unless stated

MICRO BUSINESS CENTRE LTD

1ST FLOOR
LEWIS HOUSE
LINTHOUSE LANE
WEDNESFIELD
WOLVERHAMPTON W25687

If that Apple
is just out of Reach....

Rent One!

Now you can get invaluable hands-on experience with a microcomputer before committing yourself — its the only practical, low cost way of discovering which is the right system for you.

Apart from Apples we maintain a vast range of micros, printers, monitors, accessories and software, supplied by helpful, friendly and professional people.

systems from **£12.00** p.w.

Atlanta Data Systems

350/356 Old Street, London, EC1V 9DT. 01-739 5889

● Circle No. 378



INSTANT ROM Socket Adaptors.

These Adaptors give increased flexibility in the use of available ROM sockets. An extra ROM/EPROM can share the same socket as an existing ROM, even when in a Basic socket. The ROMs may be switched in and out under software control during the running of a program.

The Adaptors plug directly into standard 24-pin sockets, and are available for all types of ROM/EPROM, from 2Kbytes to 8Kbytes.

GA2 — enables two 2K, 4K or 8K ROMs/EPROMs to share the same memory space in the same socket. Switching from one ROM to the other is by a shorting link, or under software control using GA3 £15

GA3 — 8-bit Output Port. Gives 8 individually selectable output lines. For Software selection of ROMs/EPROMs in the Adaptors described, or for general use. Shares a socket with any existing ROM/EPROM, even in a Basic socket, and uses no memory space. Accessed by a simple POKE command £21

GA4 — 'Socket Saver'. Protects ROM sockets from damage from continual insertions and withdrawals £3

GA5 — Allows a 2332/2532 (4K) to be used in a 2316/2516 (2K) sockets. The upper or lower half of the ROM is selected by a shorting link, or under software control using GA3 £4

GA6 — For using a 2732 (4K) in a 2716 (2K) socket. Selection as GA5 £4

GA7 — For using a 2364 (8K) in a 2332/2532 (4K) socket. Selection as in GA5 £4

GA8 — Permits two 2K devices to be used in a 4K socket, or two 4K devices to be used in an 8K socket. Automatic selection £4

ALL the above Adaptors may be used with INSTANT ROM Rom-Emulators, and will function in any type of Microcomputer. They are especially useful in the PET.

PETCLOCK — Type GCC1. Clock/Calendar for the PET/CBM. Plugs into the User Port. gives date, time and variable interrupt output. No power supply needed. Battery back-up with 10 years life £62

NEW — 8-bit Analog-to-Digital-Converter. A low cost device that plugs into any ROM socket and digitises the voltage output from an external sensor. No software needed — just PEEK the ROM 1, 2 and 4-channel versions, with optional signal conditioning modules for scaling of outputs from thermocouples, strain gauges, etc.

SEND FOR FULL DATA SHEETS

Prices include Post and Packing in UK; VAT is extra.

GREENWICH INSTRUMENTS LTD, 22 BARDSEY LANE
GREENWICH, LONDON SE10 9RF.

Tel: 01-853 0868. Telex: 896691 TLXIR G/GIL.

● Circle No. 379



centralex

CENTRALEX-LONDON LTD

8-12 Lee High Rd, London SE13

Tel: 01-318 4213/4/5/6/7

9.30 am - 5 pm Mon to Fri -

Evenings and weekends by appointment

A comprehensive range of Microcomputers Equipment, Peripherals, Software and Services for those who value Professional Standards, Guidance and Continuing Support for Hardware and Software.

APPLE
TEXAS
MICROPOLIS
DIABLO
MICROLINE

PET
OHIO SCIENTIFIC
CENTRONICS
QUME
HITACHI

ITT 2020
CROMEMCO
ANADIX
DEC
LEXICON

EXIDY
MICROSTAR
INTEGRAL
DATA GENERAL
ETC. ETC.

HORIZON
SHUGART
TELETYPE
EPSON

INFORMEX-80 Printer

£399+VAT



Special offer - for a limited period

For PET, APPLE, EXIDY, TRS80, ETC
A high quality, high speed printer
(125 cps) Upper and lower case letters
plus graphics as standard
Interface and cable for TRS80, PET,
APPLE or RS 232 £69 + VAT
Tractor feed option only £39

ALSO Training, Consultancy, Systems Design,
Programming and Software

PAYROLL - INVOICING - STOCK CONTROL -
SALES/PURCHASE LEDGER - VAT - MEDICAL
RECORDS - EDUCATIONAL & ENGINEERING
PROGRAMMES - HOTEL RESERVATION - ESTATE
AGENTS - BUILDING MAINTENANCE - COBOL -
FORTRAN - ETC.

Maintenance Contracts including stand-by equipment during repair periods - Free Delivery Nationwide - Terms arranged - Credit Cards and official orders accepted.

● Circle No. 380

The Exhibition Which Works For You

MICROSYSTEMS '82

WEST CENTRE HOTEL,
LONDON
FEBRUARY 24-26, 1982

Over 6300 quality visitors attended the 1981 show — providing the correct balance of users and specifiers of your products and services. The formula is right — you can make MICROSYSTEMS '82 work for you by reserving your stand space NOW.

Find out how exhibiting at MICROSYSTEMS '82 can work for you by completing and returning the coupon now, to:
Exhibition Manager, MICROSYSTEMS '82, IPC Exhibitions Ltd.,
Surrey House, 1 Throwley Way, Sutton, Surrey SM1 4QQ.

MICROSYSTEMS '82 is sponsored by Computer Weekly, Systems International, Practical Computing, Your Computer, Computer Talk, Office Systems, Data Processing and Microprocessors and Microsystems and organised by IPC Exhibitions Ltd.

Please send details of exhibiting at MICROSYSTEMS '82, to:

Name _____
Position in company _____
Company _____
Address _____
Tel. No. _____

COMPUSENSE — 6800/9

THE SPECIALISTS

- Complete 6809/6800 systems from around £800.00.
- Twin 5¼" disks + controller, £500.00 excl. VAT.
- Full range of software for 6809/6800.
- Full range of printed circuit boards.

Announcing

'TABULA RASA'

Financial modelling package for 6800/6809 system in Basic, £100.00 + VAT.

Details from

COMPUSENSE LTD
P.O. BOX 169
PALMERS GREEN
LONDON N13 4HT
TEL: 01-882 0681

● Circle No. 382

WARD ELECTRONICS

BIRMINGHAM 021-554 0708

SALES AND SERVICE

apple computer

VIDEO GENIE



From
£695

POWERFUL AND VERSATILE. ONE OF THE FINEST MICROCOMPUTERS AVAILABLE FOR BUSINESS, EDUCATION AND LEISURE. TV COMPATIBLE WITH UHF MODULATOR.



From £270

LOW PRICED AND READY TO PLUG INTO YOUR OWN TV. COLOUR £37 EXTRA. UNITS AVAILABLE EX-STOCK WITH THIS AND OTHER OPTIONS • SOUND • EXTRA MEMORY • PRINTER INTERFACE

EPSON — PRINTERS — CENTRONICS
MOLIMERX SOFTWARE

SEE AND CHOOSE FROM THIS RANGE OF TRS80 SOFTWARE DISCS AND DISK DRIVES FOR APPLE, VIDEO GENIE, TRS80 COMPUTER BOOKS ON ALL ASPECTS OF COMPUTING
C12 CASSETTES 55p each. 5¼" DISCS £2.95 each.

All the LOWE ELECTRONICS RANGE of equipment for the Computing, Amateur Radio, and Test Equipment Fields including Trio Oscilloscopes

PLEASE ADD VAT AT 15%

9am-5pm Tues-Sat
Closed Mondays.

WARD ELECTRONICS

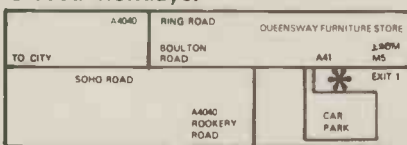

First Floor
Soho House,
362-364, Soho Road,
Handsworth,
Birmingham B21 9QL.
Tel: 021-554 0708.

● Circle No. 383

DEVELOPMENT

EPROM-PROGRAMMER ROMULATOR



2716
2732
2532
etc.

***£169
& VAT**

- 1 MONITOR or TV output (625 line UHF). Data contents of memory visible — A WINDOW IN THE CHIP.
- 2 28-KEY, 2-LEVEL KEYPAD with HEX ENTRY and EDITING CAPABILITY. (BYTES and BLOCKS of code can be changed, inserted, deleted, shifted around etc.).
- 3 INPUT and OUTPUT: SERIAL (RS232) and PARALLEL (Centronics) routines provide ready interface with computer or printer.
- 4 EMULATION of PROGRAM MEMORY in-circuit is performed by plugging SOFTY into the ROM SOCKET. A lead with a 24 pin DIL PLUG is supplied.
- 5 CASSETTE INTERFACE.
- 6 EPROM-PROGRAMMER: an EPROM may be copied or reprogrammed at the press of a key.
- 7 PERSONALITY SWITCH selects 2716, 2532, 2732.

SOFTY is used as an EPROM-PROGRAMMER, a production ROM CHECKER and for the DEVELOPMENT and PRODUCTION of PRODUCTS which contain MICRO-PROCESSORS and use EPROM for program storage.

*Price is for a BUILT and TESTED SOFTY (No kits) including POWER SUPPLY, TV LEAD, ROMULATOR LEAD, 90 DAY WARRANTY and 14 day money-back guarantee.
£169.00 + £25.35 (VAT 15%) = £194.35.

DATAMAN DESIGNS,
Lombard House, Dorchester, Dorset DT1 1RX
Dorchester (0305) 68066 (UK Sales)
Maiden Newton (0300) 20700 (Export)

● Circle No. 384

STOP!

STOP BUYING THOSE "CANNED" DATABASE PROGRAMS THAT TURN OUT TO BE COSTLY, INEFFECTIVE AND INCOMPLETE. NOW THERE IS ONE SYSTEM WITH THE POWER, THE VERSATILITY YOU NEED TO MAKE PROGRAMMING FASTER, SIMPLER AND ERROR FREE. C.O.R.P. IS A PROGRAM GENERATOR THAT WRITES SOFTWARE. COMPLETE APPLESOFT PROGRAMS THAT EXECUTE INDEPENDENTLY AND MAY BE MODIFIED BY THE USER, BASED ON INFORMATION SUPPLIED IN THE USER'S OWN EVERYDAY LANGUAGE. WHAT'S MORE, COMPLETE PROGRAM GENERATION TAKES ONLY A FEW MINUTES.

C.O.R.P.TM

PROGRAM GENERATOR

...the program that writes programs

C.O.R.P. CONSISTS OF 6 MAJOR SUBSYSTEMS: A DATA ENTRY PROGRAM GENERATOR, A SORT SUBSYSTEM, A UPDATE SUBSYSTEM, A PRINT GENERATOR AND A COMPLETE UTILITIES & DIAGNOSTIC PACKAGE. TOGETHER THE 6 SUBSYSTEMS MAKE C.O.R.P. THE MOST ADVANCED, COMPLETE AND USEFUL TOOL AVAILABLE FOR YOUR APPLE II*. ALL FOR THE INCREDIBLY LOW PRICE OF £199.00. NO OTHER PROGRAM GENERATOR OFFERS SO MUCH VERSATILITY FOR SUCH A PRICE. TO PURCHASE C.O.R.P. BRING THIS AD TO YOUR LOCAL DEALER OR ORDER FROM US DIRECTLY.

Order from **MICROSYSTEMS LIMITED**

SUMMERFIELD HOUSE, VALE, GUERNSEY, EUROPE - G.B.

Telephone: 0481 47377 Telex: 4191130 (DYN MIC G)

* C.O.R.P. is a registered trademark of the MAROMATY & SCOTTO SOFTWARE CORP.

* APPLE is a registered trademark of APPLE COMPUTER, INC.

SUPERBRAIN[®] SOFTWARE

LINTEX PRODUCTS present **LINDATA[™]**

This flexible program is vocabulary based. It was designed with ordinary business people in mind and uses YOUR names for file areas and YOUR file architectures.

Using prompts in plain English, Lindata[™] allows you to:

- ★ Sort a file numerically or alphabetically
- ★ Create file entries
- ★ Print out files in a number of formats
- ★ Alter or use field arithmetics
- ★ Edit a file on a constant keyed input

£75 + VAT including disk, comprehensive manual, packing & UK postage.
Other CP/M[™] machines by arrangement

LINTEX PRODUCTS LIMITED

16 Suffolk Road, Potters Bar, Herts EN6 3EZ Telephone Potters Bar (0707) 52834
Regular demonstrations but ONLY by appointment

● Circle No. 386

FREE

9" BLACK & WHITE MONITOR + 32K ADD-ON RAM

with every purchase of latest model of



Note: This is NOT a cheap U.S. import, but the genuine article backed up by the full one year warranty

You get:-

- * Apple II europlus 16K (incl one year warranty)
- * 32K Add-on memory ** FREE **
- * 9" Black & White monitor & cable ** FREE **
- * 3.3 DOS Disc drive & controller
- * 2nd 3.3 Disc drive

(SYSTEM VALUE £1,625 + VAT + P&P = TOTAL PRICE £1,884)

for **£1377** + VAT + P.P. TOTAL PRICE **£1599**

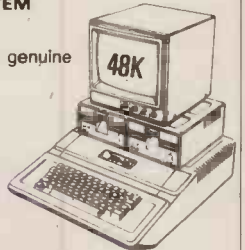

APPLE III COMING SOON ★

All prices correct at going to press. Allow 28 days delivery. CALLERS WELCOME. Send cheques, money order, bankers draft, cash with order to:



CARLTON COMPUTERS LIMITED

4 Swanston Road, Great Yarmouth, Norfolk, NR30 3NQ

Tel: 61 Yarmouth (0493) 58898

● Circle No. 387

Commodore official distributors

NEW DAISYWHEEL PRINTER IN STOCK
NEW MATRIX PRINTER NOW IN STOCK
THE RELIABLE VALUE FOR MONEY SYSTEM
WITH FULL AFTER SALES SUPPORT.



4008/16/32
8032 — 8050
8096



48K £695
DISK WITH CON. £380
DISK ... £290
FULL RANGE OF
MONITORS
B/W — GREEN OR
COLOUR.
PAPER TIGERS.

Apple authorised distributors
The sophisticated quality system with
a reputation for advanced design and
innovation.



64K From 1650
FULLY
INTEGRATED
ACCOUNTS
PACKAGE

SHARP

48K = £395
DISK DRIVES
PRINTERS ETC.



Z80K



The incredible computer system
now available ex-stock including the
New Duel Drive Double Sided Floppy Disk.

CAMDEN ELECTRONICS LTD

MICROCOMPUTER SYSTEMS

462 COVENTRY ROAD · SMALL HEATH · BIRMINGHAM B10 0UG
Telephone: 021-773 8240 or 021-772 5718 · Telex: 335909 (Camden G)



● Circle No. 388



New and popular Sams books

Mitchell Waite and Michael Pardee

BASIC Primer

£8.35 672-21586-1

Mitchell Waite

Computer Graphics Primer

£10.45 672-21650-7

Stephen Murtha and Mitchell Waite

CP/M™ Primer

£10.45 672-21791-0

Leon Scanlon

6502 Software Design

£9.05 672-21656-6

Andrew C. Staugard, Jr.

6801, 68701 and 6803 Microcomputer Programming and Interfacing

£10.45 672-21726-0

Andrew C. Staugard, Jr.

6809 Microcomputer Programming and Interfacing with Experiments

£10.45 672-21798-8

Jonathan Titus, Christopher Titus and David Larsen

TRS-80 Interfacing: Book 1

£7.65 672-21633-7

TRS-80 Interfacing: Book 2

£8.35 672-21739-2

Elizabeth Nichols, Joseph Nichols and Peter Rony

Z-80 Microprocessor Programming and Interfacing: Book 1

£9.05 672-21609-4

Z-80 Microprocessor Programming and Interfacing: Book 2

£11.15 672-21610-8

Prices are correct at the time of going to press but may be subject to change. All titles advertised are published as paperback books.

Dealer enquiries are welcome:

Please contact Roy Jones at the address below or telephone Hemel Hempstead (0442) 58531

Prentice/Hall  International

66 Wood Lane End, Hemel Hempstead, Hertfordshire HP2 4RG, England.

Exclusive distributors of Howard W. Sams books in the UK and Europe.

Sams Books Stockists

Business & Electronic Machines

7 Castle Street
Edinburgh

Byteshop Computerland Ltd

P.O. Box 2
St Neots
Huntingdon
Cambridgeshire

Cambridge Computer Store

1 Emmanuel Street
Cambridge

Datron Micro Centre

Latham House
2 Abbeydale Road
Sheffield 7

Micro-C

5-11 Martineau Way
Union Street
Birmingham

Micro-C

Unit 2, Channons Hill
Industrial Estate
Fishponds
Bristol

Micro-C

57-59 Albion Street
Leeds

Micro-C

127 Charles Street
Leicester

Micro-C

Units 91-93 Arndale Centre
Luton
Bedfordshire

Micro-C

19 Brown Street
Manchester

Micro-C

31-35 Blagdon Road
New Malden
Surrey

Micro-C

2 Wheeler Gate
Nottingham

Micro-C

10-11 Bargate
Southampton
Hampshire

Newbear Computing Store

40 Bartholomew Street
Newbury Berkshire

Silicon Centre

Pictural Electronics Ltd
21 Comely Bank Road
Edinburgh 4

Software House

Horseshoe Yard
Brooke Street
London W1

Tomorrow's World

Grafton Arcade
Grafton Street
Dublin 2

MICRO SPEECH 2

DOES YOUR COMPUTER SPEAK TO YOU?

MICROSPEECH 2 is a stand alone speech synthesizing unit. It converts phonetic code or any ASCII text into a speech output. MICROSPEECH 2 may be interfaced to any computer system because all the computation necessary to synthesize speech is performed by its own dedicated microprocessor. Up to one thousand phonetic characters, representing about one minute of speech, may be assembled in the units internal buffer before it is commanded to speak.

FEATURES

- Runs from phonetic code, giving unlimited vocabulary and simple operating software.
- Optional English to phonetics translator allows operation directly from ordinary text.
- Uses standard RS232/V24 interface.
- Totally self contained with internal loudspeaker and power supply.
- No need to worry about complex interfacing or support software.



PRICE

Phonetic model £875.00 + VAT

Phonetic model plus English to phonetics translator £950.00 + VAT

Available from:

COSTRONICS ELECTRONICS 13 Pield Heath Avenue,
Hillingdon, Middlesex Uxbridge (89) 38791
TIM ORR DESIGN CONSULTANT
55 Drive Mansions, Fulham Rd, London SW6
(01) 7312077

● Circle No. 390

MICROCOMPUTER COMPONENTS

LOWEST PRICES - FASTEST DELIVERY

Device	Price	Device	Price	Device	Price	Device	Price
MEMORIES		8797A	1.50	Z80 CPU FAMILY		EF6862	0.81
2114L-200ns	1+1.28	8798	1.50	Z80 CPU	4.00	EF6871-A1T	10.70
	25+1.19			Z80A CPU	4.82	EF6880	1.07
2114L-300ns	1+1.28			Z80A CTC	4.00	EF6887	0.80
	25+1.19	DATA CONVERTERS		Z80A DART	7.18	EF68488	9.11
2708 450ns	1.99	ZN425E-8	3.50	Z80A DART	7.18	EF6875	4.18
2716 450ns	1+2.49	ZN426E-8	3.00	Z80 DMA	11.52	8080 FAMILY	
	25+2.37	ZN427E-8	6.28	Z80 DMA	9.99	SY6502	4.95
2716 350ns	0.95	ZN428E-8	4.78	Z80 DMA	9.99	SY6520	3.15
2532 450ns	1+5.50	ZN429E-8	2.10	Z80 PIO	3.78	SY6522	4.95
	25+5.31	ZN432CJ-10	28.09	Z80A PIO	3.78	SY6532	7.95
2732 450ns	1+4.80	ZN433CJ-10	22.59	Z80 SIO-0	13.95	8080 FAMILY	
	25+4.08	ZN440	56.63	Z80 SIO-0	13.95	8085A	5.50
4116 150ns	1+1.15	MISCELLANEOUS		Z80 SIO-1	13.95	8216	1.70
	25+1.08	AY-3-1015	3.90	Z80 SIO-2	13.95	8224	2.45
4116 200ns	1+0.80	AY-5-1013	3.45	Z80A SIO-2	13.95	8228	3.95
	25+0.72	AY-5-2376	6.95			8251	3.95
6116 200ns	10.95	MC1488	0.84	EF6800 FAMILY		8253	7.95
4118 200ns	3.90	MC1489	0.84	EF6800	3.70	8255	3.95
8264 200ns	12.00	MC1441	0.84	EF6802	5.11	LOW PROFILE OIL SOCKETS	
5516 200ns	22.88	MC1442	7.99	EF6803	11.80	Number of Pins	
CRT CONTROLLERS AND GRAPHIC DISPLAY PROCESSORS		RD-3-2513L	7.70	EF6809	11.95	8	0.07
EF9364	5.94	RD-3-2513U	7.70	EF6810	1.35	14	0.09
EF9365	62.90	ZN450E	7.61	EF6821	1.74	16	0.09
EF9366	62.90	7805	0.50	EF6840	4.20	18	0.15
		7812	0.50	EF6845	9.50	20	0.17
		7905	0.55	EF6850	1.70	22	0.21
		7912	0.55			24	0.23
BUFFERS						28	0.25
81LS95	0.90					40	0.29
81LS96	0.90					CRYSTALS	
81LS97	0.90					1 Mhz	3.00
81LS98	0.90					1.8432 Mhz	2.50
8T26A	1.50					4 Mhz	1.65
8T28A	1.50						
8T95	1.50						

CHRISTMAS SPECIAL OFFER
10% DISCOUNT ON ANY ORDER IF ACCOMPANIED BY THIS ADVERTISEMENT

OFFICIAL CREDIT CARD ORDERS QUANTITY
ORDERS WELCOME WELCOME DISCOUNTS AVAILABLE
All prices exclude post and packing on orders under £10 (50p) and VAT (15%).
ALL ORDERS DESPATCHED ON DAY OF RECEIPT WITH FULL REFUND FOR OUT OF STOCK ITEMS IF REQUESTED.
24-hour Telephone Credit Card Orders

MIDWICH COMPUTER CO. LTD.

(Dept PC)

HEWITT HOUSE, NORTHGATE STREET,
BURY ST. EDMUNDS, SUFFOLK IP33 1HQ
TELEPHONE: (0284) 701321 TELEX: 817670

● Circle No. 391

TRIDATA COMPLETE BUSINESS SOFTWARE PACKAGES

- * SALES INVOICING for use on
- * SALES LEDGER
- * PURCHASE LEDGER
- * NOMINAL LEDGER
- * PAYROLL
- * STOCK CONTROL
- * TANDY TRS 80
- * TANDY TRS 80 Mk. II
- * SHARP MZ-80K
- * PET AND SUPERPET
- * APPLE

Our business packages are supplied with master diskettes, detailed operating manuals and training procedures. For small businesses and traders with up to 700 employees, 9,999 customers and 9,999 suppliers, our proven programs written by experienced DP professionals provide fast, simple control, with built in security routines for prevention of unauthorised use, abuse or mishandling. Over 550 Tridata business systems are now in use.

TRIDATA WARRANTY

Every Tridata program has a written 12 month warranty and can be automatically updated to conform to any legislation that may alter your accounting procedures.

SEND THE COUPON TODAY
OR TELEPHONE
021-622 6085

Tridata

TRIDATA MICROS LTD., Smithfield House, Digbeth, Birmingham

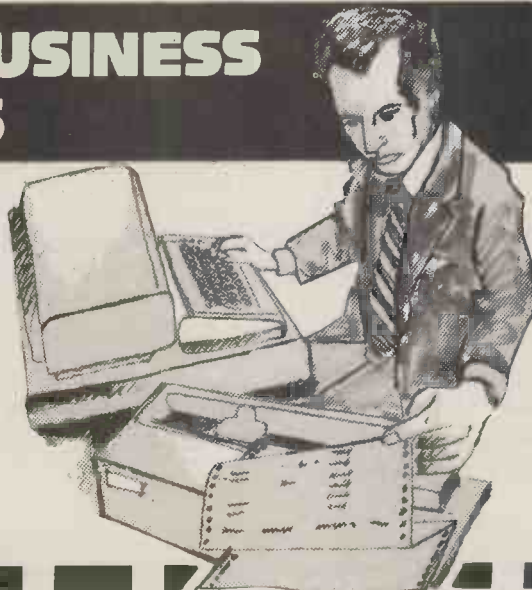

Send me details of the Tridata Business Software Systems. I am interested in
PURCHASE LEDGER For TANDY TRS 80
SALES LEDGER TANDY TRS 80 Mk. II
PAYROLL SHARP MZ-80K
NOMINAL LEDGER PET
SALES INVOICING SUPERPET
STOCK CONTROL APPLE
Name _____

Company _____

Address _____

PC 12/81

TRIDATA MICROS LTD., Smithfield House, Digbeth, Birmingham B5 6BS

● Circle No. 392



Over the last two years more than 1,000 completely non-technical users in the UK alone used one British program to keep student records, personnel files, mailing lists, sales records, parrot breeding records, man hole cover records, electoral roll records, blood donor records, pharmacy records, patient records, stock records, library lists, dating agency files, parts files, exchange rate files, employment files, accountant and solicitors records, farm records, garage records etc, etc.

How could YOU use Compssoft's DMS* (Data Management System) this year?

***Available on CP/M with link to Wordstar or Commodore machines linking to Wordcraft, Wordpro, and Visicalc.**

Designed with the non-computer expert in mind, DMS users, ranging from those in the smallest to those in the largest multi-national companies, have followed the simple screen instructions to create their own file, store, amend, sort and search for information.

Searching on multiple parameters is easy, and these pre-selected batches of records can then be processed (e.g. update all my prices by 5% and recalculate the new inventory value), displayed, passed to the report generator, or merged with other files.

Batches of data may be deleted, and the space automatically re-used. Most importantly the file structure can be amended, adding or deleting lines as required, while still retaining existing data.

Screen layouts (as many per file as you like and all password protected), calculations and print layouts can be stored on disk for future use.

DMS can store up to 1,000 characters per record, and is backed up by its own British authors from Compssoft's base in Guildford, Surrey. We are always happy to discuss your applications or arrange demonstrations with your area dealers.

DMS will run on Equinox, PET (including 96K), Rair, Cromemco, Superbrain (including double tracking machines), Apple, Cifer, Heath, North Star, Dynabyte, Vector-graphic, Shelton, SD. In fact on any CPM-based system with floppy or hard disks.

You can contact us at

**Compssoft Ltd, Great Tangle Manor Farm, Wonersh,
Guildford, Surrey GU5 0PT.**

Telephone: Guildford 0483 505918/39665.

Software for CP/M™

Introductory Offer

20% OFF
LIST PRICE

on orders RECEIVED before 31st Dec 1981

MICRO PRO	LIST
Wordstar™ 3X	£250
Mail Merge	£ 60
Data Star	£170
Supersort I	£120
Spellstar (USA dictionary)	£120

MICRO SOFT	LIST
Basic-80 Interpreter	£150
Basic Compiler	£190
MISC	
Compiler Systems	CBasic-2 £ 65
Sorcim	Pascal/M £120
Sorcim	Supercalc £150
Ashton Tate	d Base II £380

CP/M is TM of Digital Research. WORDSTAR is TM of Micro Pro

Other Products constantly being added to our range.
Send large s.a.e. for latest list

TRADE ENQUIRIES WELCOME Ordering Instructions:
Cash with order. Specify disk format. Deduct discount.
Add £1.50 per item P&P. Add 15% VAT

the
soft
option

PO BOX 11 CRANBROOK KENT
TN17 2DF Tel: (058 080) 310

● Circle No. 394

NOW * 4 * Character Sets
512 plain
512 reverse
1024 characters

ALL -24 ON
THE SCREEN
TOGETHER

ALPHA PLUS

CP/M SET
PET/CBM SET 2 + £
NEW SCHOOL MATHS SE
ELECTRONICS & GAMES SET
OR CUSTOM CHARACTER SETS

INCA INCOMPLETE
RECORDS
ACCOUNTS

Written by Chartered Accountants to make
the production of final accounts as simple
as possible (even farm accounts)

ONLY £425

FULLY TESTED
AND GUARANTEED

AVON COMPUTER RENTALS

FREEPOST THORNBURY PC
BRISTOL BS12 1BR
TEL (0454) 415460

● Circle No. 395

MICRO NETWORKS



PM 1000 16 BIT CP/M86**

The PM1000 is remarkably low in cost it offers one of the highest performance-to-price ratios of any "truly intelligent" terminal available today. It boasts a full page display. Up to 66 lines of 80 characters. Unique proprietary word processing software and split-screen display for comparing related documents. Best of all, you receive your PIICEON terminals when they are promised, no excuses.

Languages:

BASIC (Microsoft)
 CIS COBOL (Micro Focus) **Free Application Software**
 Future: PASCAL **given with every system**



NEW PM 2010

An 8086 based CPU. Built on a single easily accessible PC Board with 32K of RAM standard. The Model 2010 is plug compatible with any computer supporting standard ASCII terminals and is capable of going well beyond this via the most complete set of ANSI standard terminal control functions available in the industry.

A CORVUS computer disk system provides 6, 11 or 20 million Bytes of unformatted storage.

The price includes:

A single enclosure that contains

A Winchester disk drive.

A power supply and an intelligent controller.

An interface card with a 5 foot cable for the specific computer.

System software and installation manual mirror back-up to V.C.R.

Networking and Multiplexors.

LOW LOW PRICES

CORVUS DISK SYSTEMS

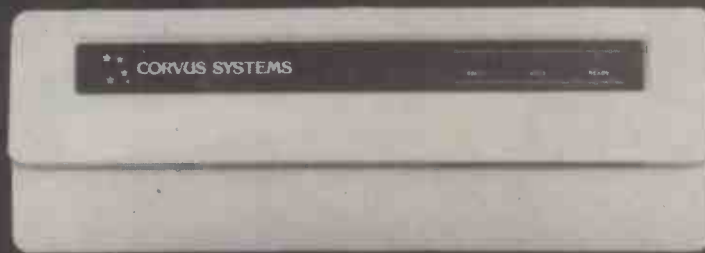

NEC SPINWRITERS



The new NEC 3500, 5500 and 7700 Series of Spinwriter™ are top quality printers setting new standards for today's most demanding office printing tasks.

DIABLO PRINTERS

- * Print speed up to 40 cps.
- * RS-232-C and CCITT V.24 serial interface.
- * Full 128 ASCII Character set; 96 printable.
- * More than 120 print wheel type styles and fonts are available.
- * Full word processing capability.

FULL RANGE OF SYSTEM APPLICATION SOFTWARE AVAILABLE

PHONE 01-839 3701

COMPUTING TODAY: EDUCATING FOR TOMORROW

We look ahead to 1982, Information Technology Year, with a host of features on information handling, processing and storage of all kinds.

EDUCATION: we look at computing in the classroom.

PRESTEL: British Viewdata explained.

NASCOM DISCS: how one reader beat the problems by writing his own disc operating software.

PROGRAMS: we look at statistics, mathematical functions and data storage techniques.

You'll find all this and more in December's **Computing Today**. The magazine that keeps you in touch with personal computing every month. **ON SALE NOW ONLY 70p.**

HARDWARE . . . SOFTWARE . . . AT HOME . . . IN BUSINESS

computing today

ONLY 70p

● Circle No. 397

EPROMS

LOWEST PRICE EVER
FROM LEADING
MANUFACTURER
BRAND SPANKING
NEW

2708 TRIPLE RAIL £2.00

2716 SINGLE RAIL £2.50

2532 SINGLE RAIL £7.95

2732 SINGLE RAIL £7.95



COMPLETE EPROM SERVICE
INCLUDING ERASING + PROGRAMMING,
ADDRESS CHANGES

YOU NAME IT WE'LL DO IT

DISCOUNT ON QUANTITIES POA
PLEASE ADD 60p P&P + VAT @ 15%

THIS COULD BE FUN (TECHNICAL SERVICES) LTD.



Amusement Machine Repair Specialists

307 New Kings Road,
London SW6 4RF.

Telephone: 01-736 5503

PLEASE QUOTE PC1

● Circle No. 398

REAL-TIME SPECTRUM ANALYZER £340

You can now buy, for about one-sixth the price of current products, a third-octave spectrum analyzer with more features and capabilities than were previously available at any price. What's the catch?

If you don't already own a Commodore PET computer, a Radio Shack TRS-80 or Apple, you'll have to get one. This will raise the price to somewhat under one-half the price of competing products, but of course you'll also have a COMPUTER!

The THS 224 REAL-TIME FREQUENCY ANALYZER comprises a single circuit board which installs inside the PET. This board contains a set of 31 analog third-octave filters (20 Hz to 20 kHz), detectors, an analog-to-digital converter, a 1K Read Only Memory containing machine language routines which allows the PET processor to interface with the Analyzer, and the peripheral circuitry necessary to transfer analog data into the PET memory. The simplest BASIC program required to turn the PET into an analyzer is only three statements long! Much longer programs can be written to allow complete user interaction with the analyzer, including many new forms of statistical signal processing, curve weighting, voice recognition etc.

● COUNTLESS EDUCATIONAL APPLICATIONS



EXPANSION MEMORY

with space for eprom

Price
break-
through

24k
£280

32k
£325

All items can
be seen and
demonstrated at
our London showroom.
Orders accepted by
mail, phone or in person.

**PETS 8k inc. cassette
from £380**

PET IS A TRADEMARK OF
COMMODORE BUSINESS SYSTEMS

Prices exclude VAT. Send or phone
for further details and brochure.

Access, Barclaycard,
and Trustcard accepted.



UK Distributors

Feldon Audio Ltd.,

126 Great Portland Street, London W1: Tel 01-580 4314 Telex London 28668

● Circle No. 399

SHARP 48K MZ80K WITH BASIC & PASCAL

£ 345

ROCK BOTTOM PRICES FROM SHARP'S BIG DEALER

DEAL A	SHARP MZ-80K with full 48K memory, BASIC AND PASCAL	£345
DEAL B	48K MZ-80K, BASIC, PASCAL, AND FORTH +10 programs	£359
DEAL C	48K MZ-80K, BASIC, PASCAL, FORTH, 10 programs, AND FORTRAN	£379
DEAL D	everything in DEAL C AND MACHINE CODE	£395
DEAL E	48K SHARP, BASIC, PASCAL, FORTH, FORTRAN, MACHINE CODE,	£410
DEAL F	12 programs and the KNIGHT COMMANDER everything included in DEAL E plus our famous library of	
	100 PROGRAMS (see separate list)	£425
DEAL G	MZ-80P3 printer complete with interface card	£339
DEAL H	MZ-8010 interface box (takes up to five cards)	£87
DEAL J	MZ-80FD dual disc floppy drive, interface card, all cables	£575
DEAL K	MZ-80P3 printer, PASCAL, FORTH, FORTRAN and KNIGHT COMMANDER	£389
DEAL L	EVERYTHING IN DEAL K, INTERFACE BOX + 100 programs	£499
DEAL M	EVERYTHING IN DEAL J, plus our new DISC COMMANDER	£599
DEAL N	MZ-80FD dual floppy, DISC COMMANDER, FORTH, FORTRAN, + PASCAL	£625
DEAL P	48K SHARP MZ-80K, PRINTER, DUAL FLOPPY, INTERFACE BOX all connecting cables and manuals	£1345

SHARP PROGRAMS FOR THE MZ-80K, B and PC 3201

DEAL F PROGRAMS INCLUDE: 10 PIN BOWLING, POKER, SKI, SPACEFIGHTER, OTHELLO, SNAKE, 3D MAZE, STAMP OUT, MUSIC BOX, B52 ATTACK, OWARI, CUSTOMER FILE, COSMIC INVASION, STARTREK, KLINGON ATTACK, DIRECTED NUMBERS, BLACK BOX, EXPLODING ATOMS, TEACH TABLES, MULTIPLICATION, MEMORY DUMPER, DISASSEMBLER, BYTE SEARCHER, MAJOR SCALES, MORSE TUTOR, BACKGAMMON, CRIBBAGE, WIZARDS CASTLE, DIVISOR? ADVISER, MULTI?GRID, CO?ORDINWARS, ARITHMETIC, KAMIKAZE PILOT, KEYBOARD MORSE, LASER ATTACK, PONTOON, STATISTICS, GOLF, CURVE FITTING, LASER DEFENCE, TRANSMIT RTTY, COMPUTER PIANO, COMPUTER COMPOSER, BIO-RHYTHM, ANNUAL RECEIPTS, STANDARD LETTERS, etc.

note these are only supplied with deal F.
Send for our latest software list which details hundreds of Sharp programs covering games, business, education, hobby etc — everything from our new version of Space Invaders to a talking memory dumper which needs no extra speech boards!!

Dear Microfans,

We don't just sell computers we use them ourselves. We use the Sharp every day in our business to check our stock, keep the sales and purchase ledgers, generate our mailing labels, and even to assist us in servicing TV sets. We also use it for our amateur radio and music hobbies. The Sharp keeps our station log, transmits test cards, sends morse and teletype, tracks satellites etc. Our articles in Electronics and Music Maker magazine detail Sharp micromusic.

Everyone who buys a micro from Knights gets free delivery, 12 months guarantee and free membership of the International Sharp User Group. Membership costs £3 if you bought your Sharp elsewhere. The group now has 1,400 members in 37 countries thus ensuring that our customers are kept up to date with all the Sharp developments on a Worldwide basis. The latest issue details my visit to Sharp in Japan, the new languages, the compiler, double precision Basic for the B and K and masses of helpful information about Sharp which is unavailable elsewhere.

We have now produced a Disc version of our KNIGHT COMMANDER which adds AUTO LINE NUMBER, BLOCK DELETE, DUMP, RENUMBER, REPEAT ON ALL KEYS, TRACE, SINGLE STEP, USER DEFINED KEYS, and a NUMERIC PAD to the standard disc basic without taking any extra memory. It certainly surprised and delighted them at Sharp and is now on sale in Japan.

Although we are the largest Sharp micro dealer outside Japan we do give personal service — ring Alec or Graham Knight at any time if you have a query — we will do our very best to help you. Ring, write or Telex for your copies of our latest Newsletter, software lists and hardware offers.

Happy computing, 10-10, 73, 88.

Graham Knight (GM8FFX on ham radio — Sharp one on CB)

P.S. Our new 4MHz board for the MZ-80K doubles the processing speed, requires no soldering and really makes your programs zip along — details in our newsletter.

P.P.S. We now have 80 programs for the MZ-80B and offer unbeatable package deals.

NEW MZ-80K LANGUAGE TAPES

KNIGHTS WEE PASCAL commands include: insert/delete line, find/insert string, move, replace string, VAR, PROC, FUNC, ARRAY, IF... THEN... ELSE, PUT, INP, OUT, OR, XOR, AND, NOT, +, -, *, /, REMAINDER, RND, INCREMENT/DECREMENT VARIABLES. Supplied with four programs — ideal for PASCAL beginners. £20

KNIGHTS FORTH functions include: +, -, *, /, OR, AND, XOR, Stack operators: STK, CLR, DUP, DDUP, OVER, SWAP, ROT, DROP, MV, Graphics: SET, RESG, LINE, CORDV. Supplied with very fast demo programs rotating cubes, drawing circles, etc and a FORTH DISCOMPILER (similar to a disassembler but FORTH is compiled). £25

KNIGHTS FORTRAN takes 12K and is supplied with a 32K source program "Monaco Grand Prix" which you can list and learn how to get rapid movement, fast key response and sound all at the same time — impossible in Basic. Includes: MEM, GET, IOC, LOW, MOD, IRND, IABS, ISIGN, ABS, SORT, SIN, ALOG, ATAN, IOR, COS, TAN, EXP, FLOAT, IAND, XOR, IFIX, EDIT, COMPILER, ADD, INSERT, DIM, IF, DO, CALL, PAUSE, etc. Compiled programs can be saved as machine code and will then load from monitor or be transferred as OBJ files onto disc. £30

KNIGHTS MACHINE CODE for experts only. We have written this so that it can be loaded with Basic and there are no restrictions on the memory areas which can be dumped and modified. Includes FIND, TRANSFER, HEX/DECIMAL, CHARACTER DUMP/MODIFY, REGISTER DISPLAY/MODIFY, EXECUTE ADDRESS etc. £25

ALL FOUR ABOVE — KNIGHTS PASCAL, FORTH, FORTRAN and MACHINE CODE. £85

SHARP PASCAL takes 16K, very comprehensive package which supports full screen editing, case statements etc, supplied with either KNIGHTS WEE PASCAL which we recommend if you are a beginner or with our NUMERICAL INTEGRATION PACKAGE which comes with 20 pages of notes detailing the Simpson's Rule, Gauss Legendre and Gauss Laguerre methods used to make up this scientific program. £45

SHARP PASCAL FOR MZ-80B with NUMERICAL INTEGRATION PACKAGE which makes full use of the hi-res graphics for plotting curves. £50

KNIGHTS EASY ASSEMBLER written especially for the MZ-80B as Sharp themselves do not have a tape based assembler. £25

SHARP FDOS for K and B allows writing of machine code or compiled BASIC programs to disc. Details in our latest newsletter.

ALL PRICES EXCLUDE V.A.T.

108 Rosemount Place, Aberdeen AB2 4YW

Telephone: 0224 630526

Telex: 739169 "KNIGHTS TV"

Knights T.V. & COMPUTERS

HOW TO SAVE VAST AMOUNTS OF TIME ON PAPERWORK AND CALCULATIONS

Buy a Superbrain system from the London Micro Centre

Visit the London Micro Centre to see word processing and business programs in action.

We can supply you with standard programs, or we can write them specially for you so that they are tailored to your business requirements.

Our existing programs include a full range of word processing programs, plus customer and invoice programs, leads and sales programs, VAT output and debtor programs, solicitors' programs, car sales programs, order processing programs, hotel reservations programs, and an amazing new sales ledger package.

SYSTEMS AVAILABLE ON RENT, LEASE, AND HP AS WELL AS CASH

CALL OR WRITE NOW FOR
☆ DEMONSTRATIONS - QUOTATIONS - CATALOGUES ☆

We are main Superbrain and Sorcerer dealers.
We provide any printer to fit the Superbrain.
You can rent a word processor and a microsystem from us for just £12.90 per week.

THE LONDON MICRO CENTRE
47 Lower Belgrave Street, London SW1.
(only 3 mins from Victoria Station)

TEL 01 730 8791 TODAY

● Circle No. 401

"ATTENTION COMPUTER DEALERS"

Let us be your Exporter/Purchasing Agent in the United States for the following products:—

MICROCOMPUTERS:— Ohio Scientific, Onyx.

PRINTERS:— Okidata, Centronics, NEC, Xerox/Diablo, Anadex, Printerm, Eaton.

TERMINALS:— Micro-term, Televideo, Hazeltine, Zintec, Beehive.

MAG-TAPE:— Alloy engineering cartridge and reel.

FURNITURE:— Printer Stands, CRT Stands, Computer Tables.

MISC:— Blank Floppy Disks, Blank Cartridge and reel mag tape, CRT Cables, etc.

NOTE

IF YOU DON'T SEE YOUR NEEDS, PLEASE CONTACT US WITH YOUR REQUIREMENTS.

SYSTEMS INTERNATIONAL INC

**500 CHESHAM HOUSE,
150 REGENT STREET,
LONDON W1R 5FA**

**SYSTEMS INTERNATIONAL INC
15920 LUANNE DRIVE
GAITHERSBURG, MARYLAND
20760 U.S.A.**

Telephone 301-977-0100. Telex 710-828-9703
Cable Address SYSINTL. GAITHERSBURG MD

● Circle No. 402

STCS

ST Commercial Systems Ltd

Brain Specialists

**Simplify all your accounting
Sales, Purchases, Invoicing,
Payrole, Stock control
VAT Reports
Even Trial balances and
P & L Accounts**



**SuperBrain can work as a word processor
Provide All Tektronix type and graphics
and even emulate a Tektronix terminal.**

- Communications to most mainframes and MINIS
- Runs IBM "BISYNC" protocol emulating 3270s or 2780s.
- Programming languages include PASCAL FORTRAN BASIC COBOL!
- Disk capacities from 360K to 10M bytes ● Prices from **£1695** plus VAT
- Full range of C.P.M. software and peripherals
- NEC spinwriters. EPSON printer MICROPRO software
- **DEALERS BEST DISCOUNTS**
- We also sell CROMEMCO and North Star Hardware.

26 New Broadway, Ealing, London W5
Telephone: 01-840 1926

● Circle No. 403

If it's APL

HARDWARE

Superbrain

64K RAM, twin floppies holding up to 3/4Mbyte data. TIS-APL (our recommendation*), APL/V80 or Softronics. The ideal low-cost option. Prices from around £2,000. *Ask for our free booklet: TIS-APL versus APL/V80.

TRS-80

TRS-80 level I with APL-80 for hobbyists; level II with TIS-APL for business applications.

Altos

The popular ACS-800 series for multi-user APL. Features 64K RAM plus 144K RAM as virtual storage. Up to 29Mbyte hard disk storage. Two operating systems (CP/M & TIS-OS) are always available, giving the user maximum flexibility. Prices from around £6K.

SOFTWARE

APLDMS

Database management system. Full-screen edit and entry of data for speedy and convenient update. Files automatically inverted for rapid retrievals. Unique picture method to define output format. £495

APLOT

High resolution plotting packages using Qume, NEC, Hewlett-Packard flat-bed plotter, screen graphics. Prices from £495

JOT series

Wordprocessing packages. Full-screen edit; mixed character sets; direct entry of control codes; calculation capability; transfer of paragraphs.

Prices: £195, £295, £395

STAPL

Statistics functions. Pictorial and descriptive statistics; stepwise, multiple regressions; total and partial correlations; analysis of variance; distributions (X^2 , t, Gauss, Weibull, etc). Data validation and filing, etc.

Prices from £195

APLAN

Comprehensive financial planning system. Capital structure, credit management, cash management, stock management, depreciation investment analysis, financial analysis, capital budgets, cost accounting. Prices from £295

XAPL

Mainframe-to-micro, and micro-to-micro communications. £95

BOOKS

APL and Insight £2.50; Starmap £1.65; Structured Programming in APL £8.70; A Course in APL £10.25; APL — An Interactive Approach £10.25; Introduction to APL £14.00; Algebra £5.10 (Solutions, £0.80); Elementary Analysis £3.70; Introducing APL to Teachers £0.65; APL in Exposition £0.55; An Introduction to APL for Scientists and Engineers £0.65; APL Programming and Computer Techniques £12.30; Applied APL Programming £13.50; Calculus in a New Key £4.40; APL — A Short Course £10.95; APL — An Introduction £6.25; APL — The Language and its Usage £21.40; Resistive Circuit Theory £6.60; Handbook of APL £6.60; A Microprogrammed APL implementation £16.25.

CONSULTANCY

Our associates are skilled in all sorts of areas, but mostly at eliciting from you what software you need to run your business more effectively. Can you believe that a system can develop before your eyes? It's perfectly true!

COURSES

All courses are "hands-on". Nobody leaves our courses without a good working knowledge of APL. Courses & Seminars for beginners and seasoned mainframe APLers.

BULK BUYING

Buy a system from us and get substantial reductions. Example:

Standard Superbrain	£1,900
APL/ASCII char. board	£255
TIS-APL interpreter	£395
APLOMS	£495
JOT wordprocessor	£195
MUTABLE report formatter	£95
XAPL	£95
	£3,430
PACKAGED PRICE:	£2,950

Alan
Pearman
and Associates
Limited

mathematical modellers
complete APL specialists

Maple House
Mortlake Crescent
Chester CH3 5UR
Tel: 0244 46024
0244 21084

● Circle No. 404

The *pfs*: software series



A Personal Information Management System.

Your APPLE* computer really can track purchase orders and inventory, analyze your investment records, maintain client and patient histories, or even catalog magazine abstracts and your stereo collection. Software Publishing Corporation has the answer and it doesn't require programming!

We call it the PFS software series – an easy to use yet powerful set of programs that let you design a system that's versatile enough to manage almost any kind of information.

PFS, the personal filing system, lets you design your own form on the screen for organizing information. Once it's created you just fill in the blanks. Looking up what you've filed is just as easy. PFS can search for a number, a single piece of data, a word within a page of text, or any combination. All forms that match are displayed on the screen for browsing, updating, expanding, or printing. PFS can even create mailing labels.

PFS: REPORT, the personal report system, uses the files PFS creates to produce a report tailored to your

PFS is a trademark of Software Publishing Corporation.

specifications. Just mark the information you want listed and PFS: REPORT will sort it and let you specify headings, totals, averages, counts, and calculations. You can save your report design for use on a regular basis.

PFS and PFS: REPORT come with simple self teaching manuals plus a support plan that includes program updates and factory experts ready to answer your questions. And all of this at an affordable price.



*requires a 48K, 16-sector disk based APPLE II system

The PFS software series is different. It is not a specialized application package nor a complex programmer oriented data base manager. It's a personal information management system that lets you store, retrieve, and report information your way without programming.



APPLE* is a registered trademark of Apple Computer, Inc.

Software Publishing Corporation

Distributed Exclusively in U.K. & Eire by Personal Computers Limited 194/200 Bishopsgate London EC2M 4NR Tel: 01-626 8121



● Circle No. 405

THE SHARP MZ-80K HAS GOT IT ALL

STOP PRESS... NOW AVAILABLE
BASIC COMPILER
PASCAL (CASSETTE BASED)
DOUBLE PRECISION DISC BASIC

NOW ONLY
£460 R.R.P.
+Vat
48K

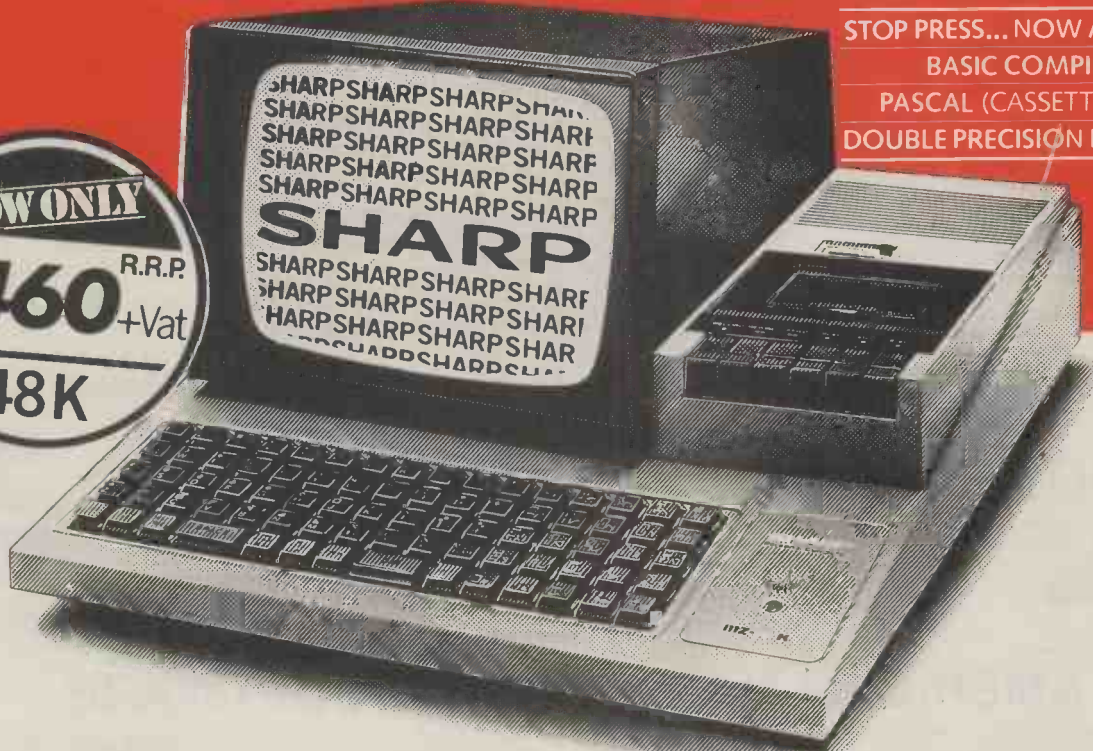

Since its introduction the Sharp MZ-80K has proved to be one of the most successful and versatile microcomputer systems around. Sharp now have a comprehensive range of products ready to make the powerful MZ-80K with its Printer and Disc Drives even more adaptable.

Products include: - Universal Interface Card, Machine Language and Z-80 Assembler packages, CP/M* plus a comprehensive range of software.

*Trade mark of Digital Research Ltd.

You'll find all the help and advice you need about the MZ-80K at your Specialist Sharp Dealer in the list below.

If there is no dealer in your area, or if you require any further information write to: - Computer Division, Sharp Electronics (UK) Ltd., Sharp House, Thorp Road, Newton Heath, Manchester M10 9BE.

SHARP
First, and foremost

GET IT ALL HERE ...

AVON
BCG Computer Systems Ltd.,
Bristol. Tel: 0272 425338
Decimal Business M/Cs Ltd.,
Bristol. Tel: 0272 294591
BERKSHIRE
Computer 100,
Bray. Tel: 0628 35619
Newbear Computing Store Ltd.,
Newbury. Tel: 0635 30505
BIRMINGHAM
Camden Electronics,
Small Heath. Tel: 021 773 8240
Electronic Business Systems Ltd.,
Birmingham. Tel: 021 384 2513
Jax Rest Ltd.,
Birmingham. Tel: 021 328 4555
Newbear Computing Store Ltd.,
Birmingham B26.
Tel: 021 707 7170
BUCKINGHAMSHIRE
Cunty's Microsystems,
High Wycombe. Tel: 0494 40262
INTERFACE COMPONENTS LTD.,
Amersham. Tel: 02403 22307
CAMBRIDGE
The Avery Computing Co Ltd.,
Bar Hill. Tel: 0954 80991
CHESHIRE
Bellard Electronics Ltd.,
Chester. Tel: 0244 380123
Charlesworth of Crewe Ltd.,
Crewe. Tel: 0270 56342
Chandos Products,
New Mills. Tel: New Mills 44344
CR Technical Services,
Chester. Tel: 0244 317549
Fletcher Worthington Ltd.,
Hale. Tel: 061 928 8928
Newbear Computing Store Ltd.,
Stockport. Tel: 061 491 2290

Ors Group Ltd.,
Warrington. Tel: 0925 67411
Sumlock Software,
Warrington. Tel: 0925 574593
CLEVELAND
Hunting Computer Services Ltd.,
Stockton-on-Tees. Tel: 0642 769709
Intex Datalog Ltd.,
Stockton-on-Tees. Tel: 0642 781193
DEVON
Crystal Electronics Ltd.,
Torquay. Tel: 0803 22699
Plymouth Computers,
Plymouth. Tel: 0752 23042
DURHAM
Neccos (DP) Ltd.,
Darlington. Tel: 0325 69540
ESSEX
Prorole Ltd.,
Westcliff-on-Sea. Tel: 0702 335298
Wilding Office Equipment,
Ilford. Tel: 01 514 1525
GLOUCESTERSHIRE
Gloucestershire Shop
Equipment Ltd.,
Gloucester. Tel: 0452 36012
The Computer Shack,
Cheltenham. Tel: 0242 584343
HAMPSHIRE
Advanced Business Concepts,
New Milton. Tel: 0425 618181
Xitan Systems Ltd.,
Southampton. Tel: 0703 39890
HEREFORD
BMP,
Little Dewchurch. Tel: 021 643 3832

HUMBERSIDE
Commercial Systems Ltd.,
Hull. Tel: 0482 20500
Silicon Chip Centre,
Gmmsby. Tel: 0472 45353
KENT
Technolink Europa Ltd.,
Tunbridge Wells. Tel: 0892 32116
Video Services (Bromley) Ltd.,
Bromley. Tel: 01 460 8833
LANCASHIRE
Nelson Computer Services,
Rawtenstall. Tel: 0706 229125
Sumita Electronics Ltd.,
Preston. Tel: 0772 51686
The Micro Chip Shop,
Blackpool. Tel: 0253 403122
LEICESTERSHIRE
Gilbert Computers,
Lubenham. Tel: 0858 65894
G.W. Cowling Ltd.,
Leicester. Tel: 0533 553232
Leicester Computing Centre,
Leicester. Tel: 0533 556268
Mays Hi-Fi,
Leicester. Tel: 0533 22212
LINCOLNSHIRE
Howes Elect & Autom. Servs.,
Lincoln. Tel: 0522 32379
Z.R. Business Consultants,
Lincoln. Tel: 0522 31621
LONDON
Bridgewater Accounting,
Whelstone. Tel: 01 446 0320
Butel-Comco Ltd.,
Hendon. Tel: 01 202 0262
Central Calculators Ltd.,
London EC2. Tel: 01 729 5588
Deans,
London W8. Tel: 01 937 7896

Digital Design and Development.
London W1. Tel: 01 387 7388
Euro-Calc Ltd.,
London EC2. Tel: 01 729 4555
Lion Computing Shops Ltd.,
London W1. Tel: 01 637 1601
Scope Ltd.,
London EC2. Tel: 01 729 3035
Sumlock Bondain Ltd.,
London EC1. Tel: 01 253 2447
MANCHESTER
The Byte Shop,
Manchester M1. Tel: 061 236 4737
Sumlock Electronic Services Ltd.,
Manchester M3. Tel: 061 834 4233
MERSEYSIDE
Microdigital Ltd.,
Liverpool. Tel: 051 227 2535
NORFOLK
Sumlock Bondain (East Anglia)
Norwich. Tel: 0603 26259
NORTHAMPTONSHIRE
Computer Supermarket,
Corby. Tel: 05366 62571
NORTHERN IRELAND
Biomac (UK),
Co Antrim. Tel: 023831 3394
O & M Systems,
Belfast. Tel: 0232 49440
NOTTINGHAMSHIRE
Mansfield Business M/C Ltd.,
Mansfield. Tel: 0623 26610
OXFORDSHIRE
Oxford Computer Centre,
Oxford. Tel: 0865 45172
REPUBLIC OF IRELAND
O'Connor Computers Ltd.,
Galway. Tel: 0099 61173
Sharptext,
Dublin 2. Tel: 0001 764511
Tomorrow's World Ltd.,
Dublin 2. Tel: 0001 776861

SALOP
Computer Corner,
Shrewsbury. Tel: 0743 59788
SCOTLAND
A & G Knight,
Aberdeen. Tel: 0224 630526
Business and Electronics M/Cs,
Edinburgh. Tel: 031 226 5454
Esco Computing Ltd.,
Glasgow. Tel: 041 204 1811
Micro Centre,
Edinburgh. Tel: 031 556 7354
Micro Change,
Glasgow. Tel: 041 554 1462
Microforth,
Dunfermline. Tel: 0383 34954
Moray Instruments Ltd.,
Elgin. Tel: 0343 3747
Pointer Business Equipment Ltd.,
Glasgow. Tel: 041 332 3621
SOMERSET
Norsel Office Supplies Ltd.,
Cheddar. Tel: 0934 742184
STAFFORDSHIRE
W.B. Computer Services,
Cannock. Tel: 0543 75555
SUFFOLK
C.J.R. Microtek Co. Ltd.,
Ipswich. Tel: 0473 50152
SURREY
3D Computers,
Surliton. Tel: 01 337 4317
Micralines Ltd.,
Kingston. Tel: 01 546 9944
Petalect,
Woking. Tel: 04862 69032
R.M.B. Ltd.,
Croydon. Tel: 01 684 1134
Saradan Electronic Services,
Wallington. Tel: 01 669 9483

Also at selected Lasky's and Wildings Office Equipment Branches

● Circle No. 406

HOW TO GET MORE FROM YOUR MICRO

CP/M* Courses for micro computer users

OBJECTIVES

To familiarise the new user with the operation of the typical hardware attached to a disc-based Z80 microprocessor system.

To give the user an understanding of the facilities available in the operating system CP/M, of its management of disc files, and of its adaptation to different hardware configurations.

To give the user hands-on experience which enables this knowledge to be put to practical use.

To acquaint the user with the range of programming languages and packages which are compatible with CP/M.

Programming in Basic

OBJECTIVES

To give the student a thorough understanding of the BASIC language.

To enable the student to put the knowledge gained into practical use, facilitated by hands-on sessions and practical exercises.

Programming in CIS Cobol**

OBJECTIVES

To give a sound knowledge of the Ansi '74 Cobol programming language, highlighting differences between various dialects particularly CIS Cobol.

To provide an understanding of structured programming techniques as used in CIS Cobol.

Programming in PASCAL

OBJECTIVES

To provide an understanding of structured programming techniques as used in PASCAL.

To give a thorough knowledge of the PASCAL programming language.

To provide practical experience in using PASCAL on a microcomputer.

CONTACT:

**The Courses Secretary,
Computer Training & Education Centre Ltd,
102-108 Clerkenwell Road,
London EC1. 01-251 4010.**

*CP/M is the T/M of Digital Research Corp.

† Wordstar is the T/M of Micropro International Corp.

**CIS Cobol is the T/M of Microfocus.

*A 'must' for Micro Users.
Learn how to get the most
out of your system.*

Wordstar I Wordprocessing

OBJECTIVES

To give the user an understanding of the facilities available in the Wordstar/Mailmerge Wordprocessing System.

To give the user hands-on experience which enables this knowledge to be put to practical use.

INTRODUCING COMPUTERS

**A series of 1-day courses
for businessmen**

AN INTRODUCTION TO COMPUTERS

**MANAGING COMPUTERS IN YOUR
BUSINESS**

**MANAGING WORD PROCESSING IN
YOUR BUSINESS**

(Course fees include lunch)



A professional organisation with first class training facilities in central London.

Please send me further information on the above courses

Name

Position

Company

Address

.....Tel. No.

● Circle No. 410



Electronic Brokers

LOW - COST VDU's

Hazeltine VDU's



H1000 The low, low priced teletypewriter-compatible video display terminal, offering your choice of transmission speeds up to 9600 baud as well as parity generation and checking. 12 x 80 display upper case ASCII, RS232 interface, choice of baud rates Standard baud rates either (a) 110/300 or (b) 300/1200. (£25 surcharge for other combinations up to 9600 baud).
SUPER VALUE £199.00

H2000 Superb spec. including full XY cursor addressing and edit facility. 27 x 74 display, upper case ASCII, RS232 interface, switch-selectable baud rates **£299.00**

H2000C NOW ALSO AVAILABLE with 25 x 80 line format and C-MOS logic **£375.00**

Modular One. Now with upper/lower case, XY cursor addressing, 24 x 80 line display, dual intensity detachable keyboard, choice of 8 transmission rates up to 9600 baud **£399.00**

Also available from time to time
Hazeltine 1500 from **£575.00**
Hazeltine 1510 from **£650.00**

NEW GP80 PRINTER

BRAND NEW — LOW COST MATRIX PRINTER IDEAL FOR MICROPROCESSOR USERS SUCH AS HOBBYISTS & EDUCATIONALISTS OR ANY LOW-BUDGET APPLICATION

Selkosh GP80



NEW

- ★ Full upper/lower case ASCII PLUS GRAPHIC Mode
- ★ 80-column printing with adjustable tractor feed
- ★ Standard and double-width characters (12 cpi and 6 cpi)
- ★ 30 cps print speed with 1-line buffer
- ★ Standard parallel (Centronics-type) interface
- ★ Optional interfaces available for RS232, IEEE488, Tandy, PET, Apple II
- ★ ONLY **£199.00**

TELETYPE OFFERS

Reconditioned ASR33 Teletype Terminals with paper tape punch and reader, even parity keyboard and RS232 interface.

SPECIAL OFFER — SEVEN DAY WARRANTY — CASH AND CARRY ONLY **£295.00**

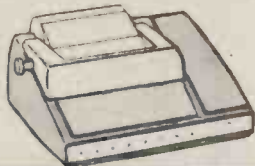

Low Cost Printer offer.
Teletype 33 printer mechanism including case but no keyboard or electronics. 64 upper case ASCII, 10 cps, pinfeed platen, ideal for the electronic hobbyist ONLY **£85.00**

DEC SALE

Huge stocks of DEC processors, peripherals, disk drives, terminals, add-on memory, option modules, etc. etc. Send for latest list

Electronic Brokers Limited
61/65 Kings Cross Road
London WC1X 9LN England
Telephone: 01-278 3461
Telex: 298694 Elebro G

All items reconditioned unless otherwise stated
Hours of Business: 9a.m. - 5p.m. Mon-Fri. Closed lunch 1-2p.m.
ADD 15% VAT TO ALL PRICES
Carriage and Packing charge extra on all items unless otherwise stated. A copy of our Trading Conditions is available on request

● Circle No. 411

Mailing Floppy Disks?

Use Swan Disk Mailers — and get Safety in the Mail

Now used by over 1,000 computer companies, Swan Disk Mailers provide outstanding postal security at economical prices.

Combining great strength with simplicity of use, Swan Disk Mailers are manufactured from rigid white corrugated, holding up to four disks.

There are two sizes available: 8-75" X 8-75" & 6" X 6"



ring
01-607 9938
for Free samples
and prices

● Circle No. 412

Conquer the chip!

The silicon 'Chip', the microprocessor, and the whole field of modern electronics will revolutionise every human activity over the next decade If you are looking for a new job or career, promotion, your own business or simply want to keep abreast of modern developments — you will need to master the subject. It can be done simply and efficiently, in a practical way. No previous knowledge is needed. Write to us now — without the slightest obligation. . . . We have been successfully training people in electronics, at home, for over 40 years!



MASTER ELECTRONICS LEARN THE PRACTICAL WAY BY SEEING AND DOING

- Building an oscilloscope. ● Recognition of components.
- Understanding circuit diagrams. ● Handling all types Solid State 'Chips'.
- Carry out over 40 experiments on basic circuits and on digital electronics.
- Testing and servicing of Radio, T.V., Hi-Fi and all types of modern computerised equipment.

MASTER MICROPROCESSORS

LEARN HOW TO REALLY UNDERSTAND MICROPROCESSORS, HOW THEY WORK AND THEIR APPLICATION TO COMPUTER TECHNOLOGY.

- Complete Home Study Library ● Programming
- Special Educational Microprocessor Equipment supplied
- Services of skilled tutor available throughout course

MASTER THE REST

- Radio Amateurs Licence ● Logic/Digital techniques
- Examination courses (City & Guilds etc.) in electronics
- Semi-conductor technology
- Training Kits (Signal Generators, Digital Meters etc.)

FREE	Please send your FREE brochure without obligation to —	I am interested in —
	Name	PRACTICAL ELECTRONICS
	Address	MICROPROCESSORS
	OTHER SUBJECTS (please state your interest)
BLOCK CAPS PLEASE		

BRITISH NATIONAL RADIO & ELECTRONICS SCHOOL
READING, BERKS. RG1 1BR PC/12/817R

● Circle No. 413

MAPLIN for ATARI

AUTHORISED DEALER



The World-beating ATARI PERSONAL COMPUTERS

3 consoles available

Atari 400 with 16K RAM (AF36P) £345

Atari 400 with 32K RAM (AF37S) £395

Atari 800 with 16K RAM (AF02C) £645
(expandable to 48K)

All consoles when connected to a standard UK colour (or black and white) TV set can generate the most amazing graphics you've ever seen.

Look at what you get:

- * Background colour, plotting colour, text colour and border colour settable to any one of 16 colours with 8 levels of illuminance!
- * Video display has upper and lower case characters with true descenders, double and quad size text and inverse video.
- * 57-Key keyboard (touch type on Atari 400) and four function keys.
- * Full screen editing and four-way cursor control.
- * 29 keystroke graphics and plottable points up to 320 x 192 (160 x 96 only with 8K RAM).
- * 40 character by 24 line display.
- * Extended graphics control and high speed action using a DMA chip with its own character set.
- * Player missile graphics.
- * Four programmable sound generators can be played individually or together and each has 1785 possible sounds playable at any one of eight volume settings, for game sounds or music.
- * Full software control of pitch, timbre and duration of notes in 4-octave range.
- * Four joystick or paddle ports, sounds output to TV.
- * BASIC cartridge and 10K ROM operating system and full documentation.

Dealer enquiries welcome

MAPLIN

Maplin Electronic Supplies Ltd
P.O. Box 3, Rayleigh, Essex.
Tel: Southend (0702) 552911/554155



Atari 400 Console



Atari 800 Console (with cover removed)

MORE HARDWARE

Atari 410 Cassette Recorder (AF28F)	£50
Atari 810 Disk Drive (AF06G)	£345
Atari 822 40-column Thermal Printer (AF04E)	£265
Atari 850 Interface (AF29G)	£135
Joystick Controllers (AC37S)	£13.95
Paddle Controllers (AC29G)	£13.95
16K RAM Memory Module (AF08J)	£65

MUCH MORE FOR ATARI COMING SOON

SOFTWARE

Lots and lots of amazing software for Atari available now.

- ★ Word Processor ★ VISI-CALC
 - ★ ADVENTURE GAMES ★ Arcade Games
 - ★ Trek Games ★ ASSEMBLER & DISASSEMBLER ★ FORTH ★ Teaching
 - ★ 3D GRAPHICS ★ Character Set Generator
- SEND S.A.E. NOW FOR OUR LEAFLET (XH52G)

LE STICK

For Atari Computer or Video Game
Replaces standard joystick, but much easier to use. Internal motion detectors sense hand movements. Large pushbutton on top of Stick. Squeeze Stick to freeze motion. A MUST for SPACE INVADERS, STAR RAIDERS & ASTEROIDS.
ONLY £24.95 (AC45Y)

Note: Order codes shown in brackets. All prices include VAT and shipment by Datapost. (Errors excluded).

SPECIAL PACKAGE OFFER

Disk-based system for £725 with Le Stick
The Atari 400 Console
Special 32K RAM Module
Atari 810 Disk Drive
Disk Operating System
Documentation
Interconnecting Leads
Everything in "Look at what you get" list
Can any other computer on the market offer all this at anything like this price?

VERSAWRITER

12½ x 8in. drawing board. Drawing on board is reproduced on TV via Atari with 32K RAM and Disk Drive. Closed areas may be filled in with one of 3 colours. Text may be added in any one of 4 fonts. Paint brush mode: select size of brush and paint away. Air brush mode: shade in your drawing—colour and density is up to you. Plus many more features. S.a.e. for price and further details.

Demonstrations at our shops now.
See Atari at 284 London Road, Westcliff-on-Sea, Essex.
Tel: (0702) 554000 and at 159-161 King St., Hammersmith W6.
Tel: 01-748 0926

Old tricks for new Pets...

COMMAND-O is a FOUR KILOBYTE Rom for the 4000/8000 Basic 4 Pets with all the "Toolkit" commands RENUMBER (improved), AUTO, DUMP, DELETE, FIND (improved), HELP, TRACE (improved & includes STEP), and OFF - plus PRINT USING - plus four extra disk commands INITIALIZE, MERGE, EXECUTE, and SEND - plus extra editing commands SCROLL, MOVE, OUT, BEEP, and KILL - plus SET user-definable soft key, 190 characters - plus program scroll up and down - plus 8032 control characters on key. Ask for Model CD-80N for the 8032 or CD-40N for the 4016/4032. £50.00 plus Vat

New tricks for old Pets...

DISK-O-PRO is a FOUR KILOBYTE Rom that upgrades 2000/3000 Pets, but lets you keep all your old software - including Toolkit. As well as REPEAT KEYS and PRINT USING, you get all the Basic 4 disk commands CONCAT, DOPEN, DCLOSE, RECORD, HEADER, COLLECT, BACKUP, COPY, APPEND, DSAVE, OLDAD, CATALOG, RENAME, SCRATCH and DIRECTORY - plus extra disk commands INITIALIZE, MERGE, EXECUTE and SEND - plus extra editing commands SCROLL, MOVE, OUT, BEEP and KILL - plus SET user definable soft-key, 80 characters - plus program scroll-up and scroll-down. We recommend the 4040 disk or upgraded 3040 for full benefit of disk commands. Ask for Model DOP-15N for new Pets 2001-3032, and 2001-8 with retrofit Roms & TK150P Toolkit. £50.00 plus Vat, other models available.

PRONTO-PET hard/soft reset switch for the 3000/4000 Pets. We don't think you'll "crash" your Pet using our software, but if you do the Pronto-Pet will get you out! Also clears the Pet for the next job, without that nasty off/on power surge. £9.99 + Vat

and no tricks missed!

KRAM Keyed Random Access Method. Kid your Pet it's an IBM VSAM disk handling for 3032/4032/8032 Pets with 3040/4040/8050 disks means you retrieve your data FAST, by NAME - no tracks, sectors or blocks to worry about. Over 2,500 users worldwide have joined the "Klub"! Now you can too, at the 1981 price, £75.00 plus Vat.

SPACEAKER All our Rom products are compatible with each other, but should you want, say, Wordpro with Kram, or Disk-o-pro with Visicalc, then SPACEAKER will allow both Roms to address one Rom socket, with just the flip of a switch, for £22.50 plus Vat.

We are sole UK distributors for all these fine products. If your CBM dealer is out of stock, they are available by mail from us, by cheque/Access/Barolayard (UK post paid) or send for details.

Calco Software

Lakeside House Kingeton Hill Surrey KT27QT Tel 01-546-7258

● Circle No. 415

Everything You Always Wanted to Know about Computers and Word Processors

but never found out because of the jargon!

COME TO A FREE SEMINAR AT THE LONDON MICRO CENTRE and find out what a word processor really does:

See it in action - play with it yourself! See what our business programs do - and try them out for yourself with no obligation.

AT OUR SEMINAR, YOU CAN ASK ANY QUESTION YOU WANT AND GET AN ANSWER THAT YOU CAN UNDERSTAND. (Well, almost any question!)

Every Wednesday and Saturday at the London Micro Centre - from 10.30am till noon.

Refreshments provided.

TEL:
01-730-8791



47, Lower Belgrave Street, London, SW1.
Tel: 01-730-8791

AN EMG COMPANY

● Circle No. 416



L&J COMPUTERS

192 HONEYPOT LANE, QUEENSBURY, STANMORE, MIDDX HA7 1EE. 01-204 7525

THE "PET" SPECIALISTS



GET THE BEST OF BOTH WORLDS!

WE CAN SUPPLY ALL YOUR 'PET' NEEDS AT CASH & CARRY PRICES

4032	40 Col. PET.	£585.00*	8050	IM Byte Disk	£755.00*
8032	80 Col. PET	£755.00*	4022	Printer	£357.00*
4040	347K Disk	£585.00*	8024	Printer	£975.00*

OR WE CAN SUPPLY, INSTALL AND TRAIN YOUR STAFF AT THE NORMAL PRICE WITHOUT ANY EXTRAS!!

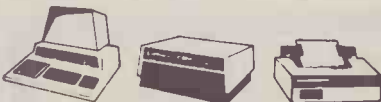

TRY US!
YOU WILL NOT BE
DISAPPOINTED

EXT CASSETTE DECKS (INC COUNTER & SOUNDBOX) £65-£55*

Printers	Disk Drives	Sundries	
CBM 4022 & 8024	CBM 8050	Interfaces:	C12 Cassettes
Centronic 779	CBM 4040	Disks:	Library Cases
Centronic 737	CBM 3040	Paper	(roll & tractor feed)
Spinwriter 5510		Labels:	Dust covers
CBM 8026 & 8027			

TOOL KITS (BASIC 2 & 4), SUPERCHIPS,
..... AND ALL SORTS OF OTHER CHIPS.....
UPGRADE YOUR PET EVEN MORE!!

THE "MUPETS" ARE HERE!
3 TO 8 PETS ONLY NEED 1 DISK DRIVE...
Daily demonstrations: Ring for details.

* PRICES DO NOT INCLUDE VAT

PERSONAL SHOPPERS WELCOME
Phone & Mail Orders accepted.

SOFTWARE

As well as a full range of Petsoft and Commodore Software, we have some highly reliable "Home-Brewed" programs available.

STOCK CONTROL & INVOICING £60
(Handles up to 500 items - 32K) (180 on 16K). Stock depleted on invoicing, search etc. Cassette, disk (& print option).

3000 item; 4040/8050 £125

CASH BOOK £90

Enter daily/weekly amounts - printout and totals, weekly/monthly analysis, totals and balances.

4032 & 8032 versions £110 & £120

STOCK TAKING for the licensing trade £240

OUTSIDE SERVICES (For Mini-Cabs etc.) £220

See for free software booklet

VISICALC "OZZ" Commodore Business Programs
COMPSOFT DMSV Bristol Trader, Item & Monitor
ANAGRAM LEDGERS Superpay Word Processing.

COME AND SEE THE NEW **VIC-20** at £189 (inc VAT)

FULLY WORKING AND OPERATIONAL
ASK US ABOUT ALL THE ADD-ON-GOODIES
THAT GO WITH THE VIC...!

ALL GOODS SENT SAME DAY WHEREVER POSSIBLE
LARGE S.A.E. FOR LISTS ETC.



● Circle No. 417

TTIs by TEXAS 74 SERIES		74193	70p	74LS197	65p	4019	32p	LINEAR I.Cs	MC1310P	150p	COMPUTER COMPONENTS																				
7400	11p	74194	70p	74LS221	60p	4020	60p	AN103	200p	MC1458	40p	CPUs	MEMORIES	INTERFACE ICs	CRYSTALS	7401	11p	74195	60p	74LS240	90p	4021	65p	AY1 0212	600p	MC1495L	350p	AD5581C	775p	32 768KHz	250p
7402	12p	74196	60p	74LS241	90p	4022	70p	AY1 1313	668p	MC1496	70p					2650A	£12	2101A	400p	AD561J	£14	100KHz	300p								
7403	14p	74197	60p	74LS242	90p	4023	24p	AY1 1320	320p	MC3340P	120p					6502	450p	21078	500p	AM25S10	350p	200KHz	370p								
7404	14p	74198	100p	74LS243	90p	4024	40p	AY1 5050	140p	MC3403	120p					6502A	650p	2111A	300p	AM26LS31	160p	1 0MHz	320p								
7405	18p	74199	100p	74LS244	90p	4025	20p	AY3 8910	700p	MC50398	750p					6800	370p	2112A	300p	AM26LS32	190p	1 008MHz	350p								
7406	27p	74200	100p	74LS245	90p	4026	130p	AY3 8912	650p	ML920	800p					6802	500p	2114 2L	160p	DA6L80	£20	1 8432MHz	250p								
7407	27p	74201	100p	74LS251	40p	4027	32p	AY5 1224A	240p	MM57160	820p					6809	£10	2114 4L	130p	DM8131	375p	2 00MHz	250p								
7408	16p	74202	100p	74LS252	40p	4028	60p	AY5 1315	600p	NE531	250p					6809E	£15	4027 3	300p	DP8304	450p	2 4570MHz	250p								
7409	15p	74203	100p	74LS253	40p	4029	75p	AY5 4007D	520p	NE555	20p					8035	760p	4044 45	700p	DS8832	250p	3 276MHz	250p								
7410	15p	74204	100p	74LS254	40p	4030	40p	CA3028A	120p	NE558	50p					8039	850p	4116 15	200p	DS8833	225p	3 5795MHz	175p								
7411	20p	74205	100p	74LS255	45p	4031	170p	CA3046	70p	NE564	420p					8080A	350p	4116 20	200p	LF13002	450p	4 00MHz	290p								
7412	20p	74206	100p	74LS260	24p	4032	125p	CA3048	225p	NE566	165p					INS8060	£11	4118 3	500p	MC1488	65p	4 194MHz	250p								
7413	25p	74207	100p	74LS262	25p	4033	180p	CA3080E	72p	NE567	140p					TMS9980	£20	4118 4	450p	MC1489	65p	4 43MHz	125p								
7414	35p	74208	100p	74LS266	25p	4034	160p	CA3086	48p	NE571	425p					Z80	370p	4164 2	£10	MC3418	950p	6 0MHz	250p								
7415	25p	74209	100p	74LS280	250p	4035	80p	CA3089E	225p	NE5534A	500p					Z80A	450p	5101	300p	MC3446	800p	6 0MHz	250p								
7416	25p	74210	100p	74LS283	45p	4036	295p	CA3090AQ	375p	PLL02A	250p					Z80A	8088	6116P 3	900p	MC3480	850p	6 144MHz	250p								
7417	25p	74211	100p	74LS298	160p	4037	60p	CA3130E	90p	RC4136	70p					Z80	8088	6514 45	400p	MC3485	500p	7 0MHz	250p								
7418	25p	74212	100p	74LS299	450p	4038	180p	CA3140E	50p	RC4151	200p					Z80	8088	6810	200p	MC4024	325p	8 00MHz	250p								
7419	25p	74213	100p	74LS323	250p	4039	60p	CA3160E	100p	S5668	260p					Z80	8088	7489	210p	MC4044	325p	8 00MHz	250p								
7420	25p	74214	100p	74LS324	180p	4040	55p	CA3161E	140p	SAD1024A	1250p					Z80	8088	74S189	325p	MM58174	£12	8 86MHz	250p								
7421	30p	74215	100p	74LS328	250p	4041	70p	CA3162E	450p	SFF96364	800p	Z80	8088	74S201	350p	ULN2003A	100p	10 0MHz	250p												
7422	22p	74216	100p	74LS348	150p	4042	40p	CA3189E	300p	SL490	350p	Z80	8088	74S289	325p	ULN2004A	100p	10 7MHz	250p												
7423	28p	74217	100p	74LS365	36p	4043	120p	CA3240E	120p	SN76477	175p	Z80	8088	74S289	325p	75017	160p	1p 0MHz	350p												
7424	25p	74218	100p	74LS368	50p	4044	75p	CA3280G	200p	SP8515	750p	Z80	8088	74S289	325p	75110	160p	16 00MHz	250p												
7425	25p	74219	100p	74LS373	80p	4045	55p	DAC1408 8	200p	TA7205	250p	Z80	8088	74S289	325p	75112	160p	18 00MHz	250p												
7426	25p	74220	100p	74LS374	80p	4046	30p	HA1388	270p	TAA621	275p	Z80	8088	74S289	325p	75114	160p	18 00MHz	250p												
7427	25p	74221	100p	74LS375	50p	4047	60p	ICL7106	850p	TBA64181	300p	Z80	8088	74S289	325p	75115	160p	19 96MHz	390p												
7428	25p	74222	100p	74LS377	90p	4048	30p	ICL8038	300p	TB7120	200p	Z80	8088	74S289	325p	75150P	140p	26 690MHz	300p												
7429	25p	74223	100p	74LS378	90p	4049	30p	ICM7555	80p	TA7204	250p	Z80	8088	74S289	325p	75154	140p	27 145MHz	250p												
7430	25p	74224	100p	74LS379	90p	4050	60p	ICM7555	80p	TA7222	200p	Z80	8088	74S289	325p	75182	220p	38 6667 MHz	350p												
7431	25p	74225	100p	74LS380	90p	4051	60p	ICM7555	80p	TA7310	200p	Z80	8088	74S289	325p	75324	325p	48 0MHz	300p												
7432	25p	74226	100p	74LS381	90p	4052	60p	ICM7555	80p	TAA621	275p	Z80	8088	74S289	325p	75361	150p	65 5MHz	400p												
7433	25p	74227	100p	74LS382	90p	4053	60p	ICM7555	80p	TAA621	275p	Z80	8088	74S289	325p	75363	150p	110MHz	350p												
7434	25p	74228	100p	74LS383	90p	4054	130p	ICM7555	80p	TAA621	275p	Z80	8088	74S289	325p	75451.2	72p														
7435	25p	74229	100p	74LS384	90p	4055	125p	ICM7555	80p	TAA621	275p	Z80	8088	74S289	325p	76453.4	72p														
7436	25p	74230	100p	74LS385	90p	4056	120p	ICM7555	80p	TAA621	275p	Z80	8088	74S289	325p	75491.2	70p														
7437	25p	74231	100p	74LS386	90p	4057	500p	ICM7555	80p	TAA621	275p	Z80	8088	74S289	325p	H126	120p														
7438	25p	74232	100p	74LS387	90p	4058	90p	ICM7555	80p	TAA621	275p	Z80	8088	74S289	325p	H126	120p														
7439	25p	74233	100p	74LS388	90p	4059	100p	ICM7555	80p	TAA621	275p	Z80	8088	74S289	325p	H126	120p														
7440	25p	74234	100p	74LS389	90p	4060	90p	ICM7555	80p	TAA621	275p	Z80	8088	74S289	325p	H126	120p														
7441	25p	74235	100p	74LS390	90p	4061	100p	ICM7555	80p	TAA621	275p	Z80	8088	74S289	325p	H126	120p														
7442	25p	74236	100p	74LS391	90p	4062	100p	ICM7555	80p	TAA621	275p	Z80	8088	74S289	325p	H126	120p														
7443	25p	74237	100p	74LS392	90p	4063	100p	ICM7555	80p	TAA621	275p	Z80	8088	74S289	325p	H126	120p														
7444	25p	74238	100p	74LS393	90p	4064	90p	ICM7555	80p	TAA621	275p	Z80	8088	74S289	325p	H126	120p														
7445	25p	74239	100p	74LS394	90p	4065	90p	ICM7555	80p	TAA621	275p	Z80	8088	74S289	325p	H126	120p														
7446	25p	74240	100p	74LS395	90p	4066	90p	ICM7555	80p	TAA621	275p	Z80	8088	74S289	325p	H126	120p														
7447	25p	74241	100p	74LS396	100p	4067	400p	ICM7555	80p	TAA621	275p	Z80	8088	74S289	325p	H126	120p														
7448	25p	74242	100p	74LS397	16p	4068	18p	ICM7555	80p	TAA621	275p	Z80	8088	74S289	325p	H126	120p														
7449	25p	74243	100p	74LS398	16p	4069	18p	ICM7555	80p	TAA621	275p	Z80	8088	74S289	325p	H126	120p														
7450	25p	74244	100p	74LS399	16p	4070	20p	ICM7555	80p	TAA621	275p	Z80	8088	74S289	325p	H126	120p														
7451	25p	74245	100p	74LS400	16p	4071	20p	ICM7555	80p	TAA621	275p	Z80	8088	74S289	325p	H126	120p														
7452	25p	74246	100p	74LS401	16p	4072	20p	ICM7555	80p	TAA621	275p	Z80	8088	74S289	325p	H126	120p														
7453	25p	74247	100p	74LS402	16p	4073	20p	ICM7555	80p	TAA621	275p	Z80	8088	74S289	325p	H126	120p														
7454	25p	74248	100p	74LS403	16p	4074	20p	ICM7555	80p	TAA621	275p	Z80	8088	74S289	325p	H126	120p														
7455	25p	74249	100p	74LS404	16p	4075	20p	ICM7555	80p	TAA621	275p	Z80	8088	74S289	325p	H126	120p														
7456	25p	74250	100p	74LS405	16p	4076	60p	ICM7555	80p	TAA621	275p	Z80	8088	74S289	325p	H126	120p														
7457	25p	74251	100p	74LS406	16p	4077	40p	ICM7555	80p	TAA621	275p	Z80	8088	74S289	325p	H126	120p														
7458	25p	74252	100p	74LS407	16p	4078	20p	ICM7555	80p	TAA621	275p	Z80	8088	74S289	325p	H126	120p														
7459	25p	74253	100p	74LS408	16p	4079	20p	ICM																							

CASTLE ELECTRONICS COMPUTER SUPERMARKET

Telephone Hastings (0424) 437875

VIC-20 COLOUR COMPUTER



- * graphics character set
- * plug-in programme/memory cartridges
- * colour * sound
- * programmable function keys
- * 5K memory expandable to 32K
- * standard PETBASIC
- * full-size typewriter keyboard
- * low-priced peripherals
- * joystick/paddles/lightpen
- * self-teaching materials

**ONLY
£189-95**

Cassette Deck now available - £44-95

Acorn Atom BRITISH DESIGNED PERSONAL COMPUTER

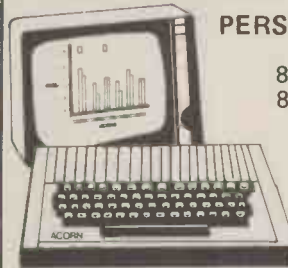

- 8K ROM + 2K RAM Kit . . . £140-00
- 8K ROM + 2K RAM Ass. . . £174-50
- 12K ROM +
- 12K RAM Kit . . . £255-00
- 12K ROM +
- 12K RAM Ass. . . £289-50
- 4K Floating Point
- ROM £ 23-00
- Colour encoder . . . £ 21-85
- Mains Power
- Supply £ 9-20

FROM £140

FREE POSTAGE AND PACKING ON ALL CASH/CHEQUE/P.O. ORDERS



COMPUTERS FOR PEOPLE



- Model 400 16K £345-00
- Model 800 16K £645-00
- Cassette £ 50-00
- Disk Drive £345-00
- 80 Col. Printer £550-00

Plus All Accessories Available.

TANGERINE microtan

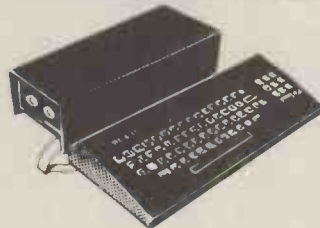

- Microtan 65 Kit . . . £79-35
- Microtan 65 Built . . £90-85
- Tanex Min.
- Config. Kit . . £49-45
- 20 Way
- Keypad £11-50

We hold a complete stock of all the Tangerine equipment. Send SAE or 'phone for details.

TANTEL PRESTEL ADAPTER - £199.00

apple computer

BUILT IN SOUND
HIGH RES. GRAPHICS

- Apple II Plus 48K £790-00
- Disc Drive + Controller . . . £383-00
- D.D. without Controller . . . £303-00
- Pascal Card £264-00
- Eurocolour Card £ 73-00
- Hitachi 9" Monitor . . . £146-00

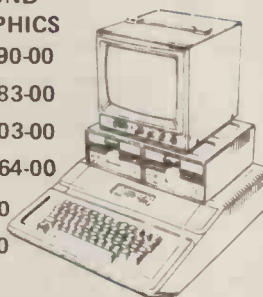

We stock all the goodies for the Apple.

COMMODORE PET

- 8K PET £458-85
- 16K PET £550-00
- 32K PET £599-00
- Dual Disc Drive . . £799-00
- Printer £454-25
- External
- Cassette £ 63-25

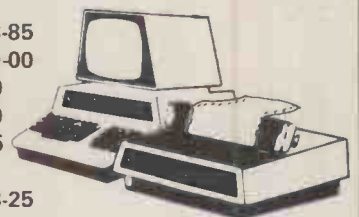

Complete range PET equipment in Stock.

CASSETTE SOFTWARE: Strathclyde Basic Course, Basic Basic Course, Invaders, Treasure Trove of Games 1 to 10 (10 selections of games), Basic Maths, Algebra, Statistical Packs and lots more!

SPECIAL OFFER - 20% OFF ALL **nascom** PRICES.
IMP PRINTER NOW £230. PHONE OR WRITE FOR DETAILS.

C.B. RIGS

MAKE: DNT 27 MHz FM. MOBILE 4 WATTS, 40 CHANNELS.
STRICTLY ACCORDING TO GOVERNMENT SPECIFICATION.
ONLY £98.25. SEND SAE FOR SPECIFICATION

ALL PRICES INCLUDE VAT. ACCEPTED. ORDERS NORMALLY DESPATCHED DAY OF RECEIPT.

CASTLE ELECTRONICS 7 Castle St., Hastings, E. Sussex
shop hours 09.00 ~ 17.30 Mon ~ Sat
personal callers welcome

NOW IN STOCK

THE NEW & EXCITING TRS80 MODEL III



48K
£619 + VAT

The Radio Shack TRS 80™ Model III is a ROM-based computer system consisting of:

- A 12-inch screen to display results and other information
 - A 65-key console keyboard for inputting programs and data to the Computer
 - A Z-80 Microprocessor, the "brains" of the system
 - A Real-Time Clock
 - Read Only Memory (ROM) containing the Model III BASIC Language (fully compatible with most Model I BASIC programs)
 - Random Access Memory (RAM) for storage of programs and data while the Computer is on (amount is expandable from "16K" to "48K", optional extra)
 - A Cassette Interface for long-term storage of programs and data (requires a separate cassette recorder, optional/extra)
 - A Printer Interface for hard-copy output of programs and data (requires a separate line printer, optional/extra)
 - Expansion area for upgrading to a disk-based system (optional/extra)
 - Expansion area for an RS-232 C serial communications interface (optional/extra)
- All these components are contained in a single moulded case, and all are powered via one power cord.

Disc Drives Kit with 2x40 Track Drives — **£599 + VAT**
Disc Drives Kit with 2x80 Track Drives — **£729 + VAT**
Add **£25** for Installation

STOCKTAKE SALE NEVER TO BE REPEATED AT THIS PRICE

EUROPE'S FASTEST SELLING ONE BOARD COMPUTER
COMPUKIT UK101



33% DISCOUNT UNTIL STOCKS LAST

COMPUKIT WITH ALL THE FEATURES THAT MADE IT THE MOST PROFESSIONAL COMPUTER KIT ON THE MARKET. Now WITH FREE NEW EXTENDED MONITOR (a saving), which includes Flashing Cursor, Screen Editing, & Save Data on Tape.

Build, Understand and Program your own Computer for only a small outlay.

KIT ONLY **£99.95 + VAT**

Fully Assembled — **£149 + VAT**

DEALER ENQUIRIES INVITED

NEW MONITOR IN ROM — available separately at **£7.90 + VAT**. Improved Basic function — revised GARBAGE routine. Allows correct use of STRING ARRAYS **£4.90 + VAT**. This chip can be sold separately to existing CompuKit and Super board users.

FOR THE COMPUKIT — Assembler Editor **£14.90** Screen Editor Tape **£1.90**
GAME PACKS — 1) Four Games **£5.00** 2) Four Games **£5.00** 3) Three Games 8K only **£5.00**
Super Space Invaders (8K) **£6.50** Chequers **£3.00** Realtime Clock **£3.00**
Case for CompuKit **£29.50** 40 pin Expansion Jumper Cable **£8.50** All Prices exclusive VAT

4K Upgrade Kit **£15.90 + VAT**

CENTRONICS 737 DOT MATRIX PRINTER



only **£369 + VAT** including cables

- Standard Features**
- 80 CPS — Proportional Spacetec Mode
 - 50 CPS
 - Monospaced Mode
 - Proportional Spacing, Plus 10 CP1 and 16.7 CP1
 - N x 9 (Proportional) or 7 x 8 (Monospaced) Dot Matrix
 - 7 x 8 Dot Matrix
 - 3 Way Paper Handling System
 - 96 Character ASCII plus 6 European character sets
 - Microprocessor Electronics
 - Expanded Print
 - Right Margin Justification
 - Print Underlining
 - 9 Wire Free Flight Print Head
 - Bidirectional Stepper Motor Paper Drive
 - Full One Line Buffer
 - 21 LPM With 80 Columns Printed
 - 58 LPM With 20 Columns Printed
 - 6 Lines Per inch Vertical Spacing
 - Paper Tear Bar
 - Centronic Colours and Logo

WE ARE NOW STOCKING THE APPLE II AT REDUCED PRICES



AUTOSTART EURO PLUS
48K
£599 + VAT

Getting Started APPLE II is faster, smaller, and more powerful than its predecessors. And it's more fun to use too because of built-in features like:

- BASIC — The Language that Makes Programming Fun.
- High-Resolution Graphics (in a 54,000 Point Array) for Finely-Detailed Displays.
- Sound Capability that Brings Programs to Life.
- Hand Controls for Games and Other Human-Input Applications.
- Internal Memory Capacity of 48K Bytes of RAM, 12K Bytes of ROM; for Big-System Performance in a Small Package.
- Eight Accessory Expansion Slots to let the System Grow With Your Needs.

You don't need to be an expert to enjoy APPLE II. It is a complete, ready-to-run computer. Just connect it to a video display and start using programs (for writing your own) the first day. You'll find that its tutorial manuals help you make it your own personal problem solver.

The PEDIGREE PETS



RRP **£795** for 32K

32K
ONLY £549 + VAT

Very popular for home & business use. 8K Microsoft Basic in ROM. 32K with new improved keyboard.
Cassette Deck **£55** extra Interface PET IEEE — Centronics Parallel Decoded **£77.00 + VAT**

SHARP PC1211



£79.90 + VAT
COMPUTER POWER THAT ONCE FILLED A ROOM CAN NOW BE CARRIED IN YOUR POCKET!

- Programs in BASIC
- "QWERTY" Alphabetic Keyboard
- 1.9K Random Access Memory
- Long Battery Life.

THE VIDEO GENIE SYSTEM

Ideal for small businesses, schools, colleges, homes, etc. Suitable for the experienced, inexperienced, hobbyist, teacher, etc.



EG3000 Series

16K
£279

WITH NEW EXTRA KEYS!

- 16K user RAM plus extended 12K Microsoft BASIC in ROM
 - Fully TRS-80 Level II software compatible
 - Huge range of software already available
 - Self contained, PSU, UHF modulator, and cassette
 - Simply plugs into video monitor or UHF TV
 - Full expansion to disks and printer
 - Absolutely complete — just fit into mains plug
- The Video Genie is a complete computer system, requiring only connection to a domestic 625 line TV set to be fully operational; or if required a video monitor can be connected to provide the best quality display. 51 key typewriter style keyboard, which features a 10 key rollover. Supplied with the following accessories:
- BASIC demonstration tape;
 - Video lead;
 - Second cassette lead;
 - Users manual;
 - BASIC manual;
 - Beginners programming manual.
- Write useful programs in the BASIC computer language yourself.



TEAC DISK DRIVES

- TEAC FD-50A has 40 tracks giving 125K Bytes unformatted single density capacity.
- The FD-50A can be used in double density recording mode.
- The FD-50A is Shugart SA400 interface compatible.
- Directly compatible with Tandy TRS80 expansion interface.
- Also interfaces with Video Genie, SWTP, TRS80, North Star Horizon, Superbrain, Nascom, etc, etc.
- Address selection for Daisy chaining up to 4 Disks.
- Disks plus power supply housed in an attractive grey case.

40 TRACK
Single Disk Drive **£225 + VAT** Double Disk Drive **£389 + VAT**
77 TRACK
Single Disk Drive **£299 + VAT** Double Disk Drive **£499 + VAT**

HITACHI PROFESSIONAL MONITORS

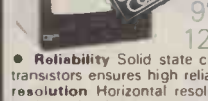

9" — **£129** **£99.95**
12" — **£199** **£149**

- Reliability Solid state circuitry using an IC and silicon transistors ensures high reliability
- 500 lines horizontal resolution
- Horizontal resolution in excess of 500 lines is achieved in picture center.
- Stable picture Even played back pictures of VTR can be displayed without jittering.
- Looping video input Video input can be looped through with built-in termination switch.
- External sync operation (available as option for U and C types)
- Compact construction Two monitors are mountable side by side in a standard 19-inch rack.

YOUR ZX80 IS NOW NO LONGER REDUNDANT
Upgrade your ZX80 to the full animated graphics of the ZX81. (No screen flicker). For only **£12.95 + VAT**, in kit form. Works only in conjunction with new 8K ROM from Sinclair (not included).

SPECIAL SCOOP GET YOURSELF A NEW MX70 PRINTER AND SAVE A FORTUNE

only **£249 + VAT**



- Interface Cards for Apple
- 80 Column,
 - Upper & lower case
 - Apple dot Graphics
 - Centronics Parallel
 - Uni-dimensional
- TX80 — **£229 + VAT** MX80 **£299 + VAT** EX-STOCK

Delivery is added at cost. Please make cheques and postal orders payable to **COMP SHOP LTD.**, or phone your order quoting **BARCLAYCARD, ACCESS, DINERS CLUB** or **AMERICAN EXPRESS** number.

MAIL ORDER AND SHOP: **CREDIT FACILITIES ARRANGED** — send S.A.E. for application form.

14 Station Road, New Barnet, Hertfordshire, EN5 1QW (Close to New Barnet BR Station — Moorgate Lane). Telephone: 01-441 2922 (Sales) 01-449 6596 Telex: 298755 TELCOM G

OPEN (BARNET) — 10am - 7pm — Monday to Saturday

NEW WEST END SHOWROOM:

311 Edgware Road, London W2. Telephone: 01-262 0387

OPEN (LONDON) — 10am - 6pm — Monday to Saturday

● IRELAND: 19 Herbert Street, Dublin 2. Telephone: Dublin 604155

● COMP SHOP USA, 1348 East Edinger, Santa Ana, California, Zip Code 92705. Telephone: 0101 714 5472526



COMP SHOP
"Europe's Largest Discount Personal Computer Stores"

ADDS

VIEWPOINT

the display terminal you can afford

Comfortably*

New to the UK market – Viewpoint, a display terminal of uncompromising quality. But with simplicity built-in too. So the price comes down... drastically.

The fact is, you could acquire *three Viewpoints for the price of two terminals* from another manufacturer.

No compromise on features either:

Full size screen... smaller space-saving cabinet.

Crisp character legibility on dark or light background; plus blinking, underlining, cursor addressing, etc.

Efficient keyboard layout plus separate 14 key cluster for cursor control keys/numerals.

Six international character sets built-in ...UK, Belgian, German, Swedish, Spanish, American, plus appropriate key caps.

Screen tilt on both models, A&B. Additionally, model B incorporates glare-reducing filter.

VIEWPOINT is available from stock through our appointed dealers. In case of difficulty contact:

Sigma
(UK)

Sigma(UK) 4 Cromwell Road Burgess Hill West Sussex Tel. (04446) 47676

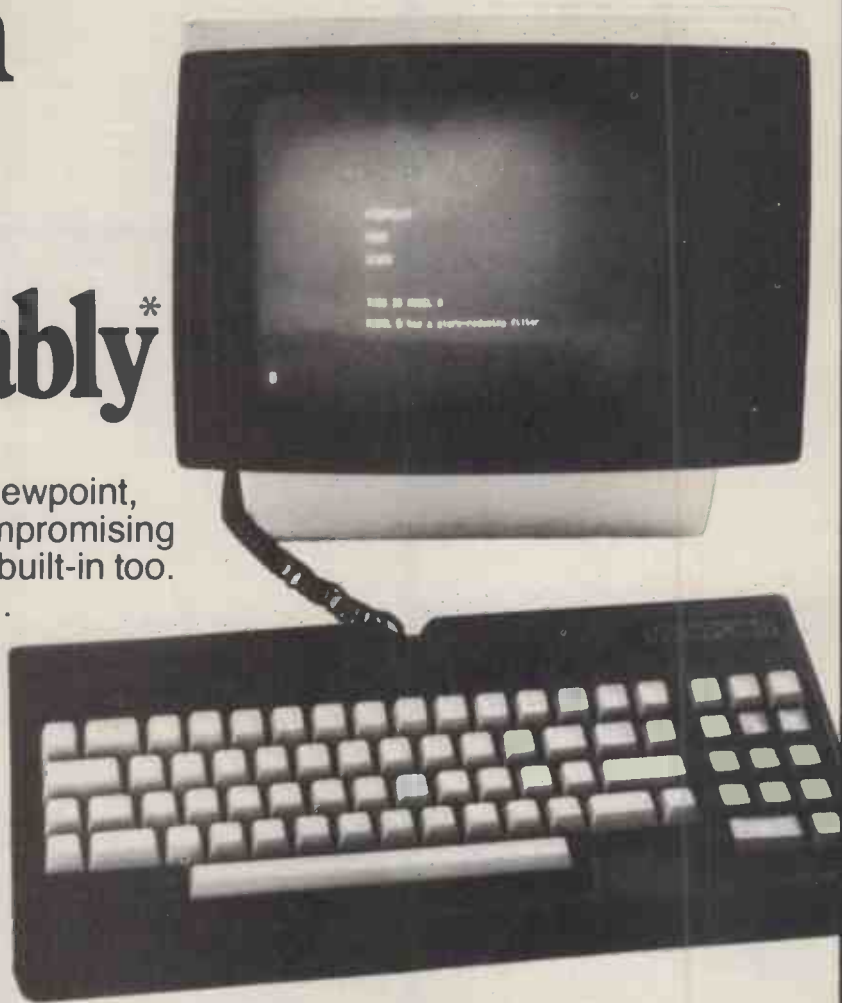

**Viewpoint features a detached keyboard connected to the CRT display by a stretch cord. So the operator can adjust keyboard position to stay comfortable...and efficient.*

GREEN & AMBER SCREEN EXCLUSIVE

New to the UK... these optional extras set new standards for clarity and easiness on the operator's eye.

DEALERS:
low cost terminal means outstanding new market opportunities

Contact Sigma (UK) for additional product information, volume discounts, sales promotion aids.



COMPLETE SYSTEM FOR
£1,190

- * 48K Apple II plus
- * Disc Drive W/Controller
- * Visicalc or Magic Window
- * Video Monitor
- * Plus 12 Months Warranty

AUTHORISED APPLE SALES AND LEVEL 1 SERVICE CENTRE



MZ-80K, 20K £399

PC i211 Computer . £75

CE 121 Interface . . £13

CE 122 Printer £69

- Programs in BASIC ● 01.9K Random Access Memory
- "QWERTY" Alphabetic keyboard ● Long Battery Life

Verbatim FLOPPY DISCS

5 1/4" SS s/density
£1.99

REDUCE Error Rate Use Cleaning Kit

LOW LOW PRICES
£16.95



Atari 400 with 8K RAM — £225
Atari 400 with 16K RAM — £295
Atari 800 with 16K RAM — £625

GAMES

Adventures: Alien Rain — Asteroid — Galaxian — Mystery House — Snoggle All at £9.95

Tarturian — Creature Venture — Apple Panic — Star Minés — Draw Poker — All at £14.95

Soft-Porn Adventure — The Wizard & The Princess — Space Eggs — Trilogy of Games — Missile Defence. All at £17.95

Hi-Res Soccer — Wrap Factor — Three Mile Island at £20.95

VACANCY: Young Sales Engineer required.

Add 15% VAT
Delivery is paid at cost.

DEANS Of Kensington
191, KENSINGTON HIGH STREET, LONDON W.8.
Tel. 01-937 7896 Ext. 3.

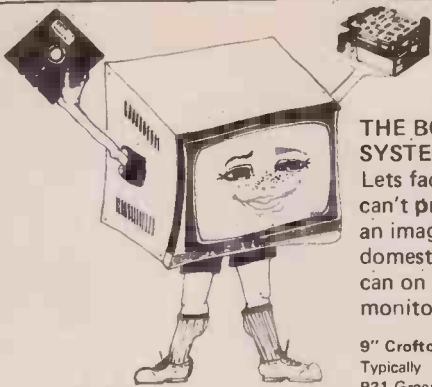

THE BODY OF ANY SYSTEM
Lets face it — you can't produce as crisp an image on a domestic T.V. as you can on a Crofton monitor.

9" Crofton Monitors
Typically P4 White £64.97
P31 Green £79.32

Monitor and floppy disc prices are dependent upon Sterling Dollar conversion rate. Phone us for up-to-date price.

SHUGART FLOPPY DISK DRIVES

No case; No Power Supply	
SA 400 5 1/4" S.S.S.D.	£149.05
SA 450 5 1/4" D.S.S.D.	£283.31
SA 800 8" S.S.S.D.	£340.52

FLOPPY DISKS — BOXES OF TEN

Single sided 35/40 Track	£ 26.45
Double sided 35/40 Track 5 1/4"	£ 37.95
Single sided 77 Track	£ 41.40
Double sided 77 Track 5 1/4"	£ 47.15
Single sided 8"	£ 40.25

IKEGAMI 12" MONITORS

P 4 White	£171.50
P31 Green	£184.97

2/3" FULLY INTERLACED C.C.T.V. CAMERAS £149.00

ALL THE ABOVE PRICES INCLUDE V.A.T. AND CARRIAGE



ALL MAJOR CREDIT CARDS ACCEPTED — Small surcharge



CROFTON ELECTRONICS LTD
35 Grosvenor Road, Twickenham, Middx TW1 4AD
01-891 1923/1513

Advertisement Index

<p>A</p> <p>Abraxus 200</p> <p>Ace 218</p> <p>Acorn Computers 115, 238</p> <p>ACT 59</p> <p>Adda 233</p> <p>AJD 30</p> <p>Almarc 127</p> <p>Altex 256</p> <p>A J Harding (Molimerx) 48</p> <p>AMA 224</p> <p>Anadex 8</p> <p>Anglia 215, 221</p> <p>A P Ltd 252</p> <p>Atlanta Data 240</p> <p>Aurac 188</p> <p>Avon 248</p> <p>B</p> <p>BHRA 222</p> <p>Biodata 190</p> <p>Bonbest 196</p> <p>BDM 236</p> <p>Brighton Computer Centre 149</p> <p>British Nat. Radio School 258</p> <p>Brittania 230</p> <p>Butel 52, 214</p> <p>C</p> <p>Caap 82</p> <p>Calco 260</p> <p>Calisto 256</p> <p>Cambridge 68</p> <p>Camden 244</p> <p>Carlton 244</p> <p>Castle 262</p> <p>Channel Islands 203</p> <p>Cheshire 34</p> <p>ChromaSonic 229</p> <p>Circle 236</p> <p>Clearsons 222</p> <p>Cleno 219</p> <p>Codified Computers 126</p> <p>Comart 5, 114</p> <p>Commodore 113, 148, 149</p> <p>Compshop 263</p> <p>Compsoft 247</p> <p>Compusense 242</p> <p>Computace 4</p> <p>Computech 195</p> <p>Computer Arts 123</p> <p>Computer Company 204</p> <p>Computer Fair 102</p> <p>Computer Interface 200</p> <p>Computer Supermarket 107</p> <p>Computers For All 110</p> <p>Computing Today 250</p> <p>Computronics 220</p> <p>Control Universal 196, 232</p> <p>Core 203</p> <p>CPS Data Systems 191</p> <p>Crofton 265</p> <p>Crystal 228, 234</p>	<p>C</p> <p>Cumana 35, 197</p> <p>CWP 213</p> <p>D</p> <p>Daléct 204</p> <p>Data Applications 140</p> <p>Dataman 242</p> <p>Datamaze 208</p> <p>Dataview 208</p> <p>Da Vinci 256</p> <p>DDP 126</p> <p>Deans 265</p> <p>D H Wooley 149</p> <p>Digico 224</p> <p>Digitus 40</p> <p>Disking 183</p> <p>DN Computers 188</p> <p>E</p> <p>Eastern Micros 230</p> <p>Eastmead 186</p> <p>Electronic Brokers 258</p> <p>Electronic Information 204</p> <p>EMG 89, 252, 260</p> <p>Equinox 42</p> <p>Essential Software (Visconti) 65</p> <p>F</p> <p>Feldon Audio 250</p> <p>Fulcrum 202</p> <p>G</p> <p>Gate 228</p> <p>GP Industrial 27</p> <p>Graffcom 199</p> <p>Gramma Winter 18, 19, 20</p> <p>Granata 202</p> <p>Greenwich Computers 240</p> <p>Guestel 121</p> <p>H</p> <p>Hal 21, 22, 23, 24</p> <p>Harmer Simpson 38</p> <p>Henrys Radios 223</p> <p>Hotel Microsystems 105</p> <p>I</p> <p>IBR 90, 91</p> <p>Icarus 25, 187, 248</p> <p>ICE 227</p> <p>IO Systems 218</p> <p>Informex (London) 240</p> <p>Interactive Data Systems 220</p> <p>Interam 145</p> <p>Intermark 234</p> <p>Ithaca Intersystems OBC</p> <p>J</p> <p>Jarrogate 234</p> <p>J J Lloyd 206</p> <p>J M Pickard 134</p> <p>K</p> <p>Keytronics 194</p> <p>KGB 44</p> <p>Kingston Computers 210</p> <p>Knights TV 251</p> <p>Kram 186</p>	<p>L</p> <p>L & J Computers 260</p> <p>Laskys 54</p> <p>Leicester Computer Centre 150</p> <p>Lifeboat Assoc. 10, 11</p> <p>Lintex 244</p> <p>Little Genius 212</p> <p>Liveport 122</p> <p>London Computer Centre 147, 194</p> <p>Lowe 12, 13</p> <p>L P Enterprises 14, 15</p> <p>LSI 131</p> <p>Lucas Logic 6</p> <p>M</p> <p>Mannesman 92</p> <p>Maplin 259</p> <p>MBS 34</p> <p>Mediatech 28</p> <p>Melbourne House 134</p> <p>Merton Electronics 202</p> <p>Metrotech 182</p> <p>Microage 214</p> <p>Microbuscentre 239</p> <p>Microcentre 192</p> <p>Microcomputer 142</p> <p>Microfacilities 206</p> <p>Microgeneral 249</p> <p>Micronetworks 266</p> <p>Micro 8 124, 129</p> <p>Micropute 188</p> <p>Microspares 16, 17</p> <p>Microsolution 32</p> <p>Microstyle 243</p> <p>Microsystems 66</p> <p>Microtanic 120</p> <p>Microtechnology 116</p> <p>Microtex 246</p> <p>Midwich 29</p> <p>Milbank 226</p> <p>Mitsui 209</p> <p>N</p> <p>Nelson 212</p> <p>Newbear 189</p> <p>Newtronics 51</p> <p>Northamber 26</p> <p>NSC 209</p> <p>O</p> <p>Onyx 37</p> <p>Oxford Computer Systems</p> <p>P</p> <p>Pearcom 84</p> <p>Pete and Pam 132, 201</p> <p>Personal Computers 254</p> <p>Phipps 238</p> <p>Prentice Hall 245</p> <p>Printout 73</p> <p>Printout Business Forms 216</p> <p>Professional Data Systems 69</p> <p>Q</p> <p>Quadruphenia 193</p>	<p>R</p> <p>Rade 7, 9</p> <p>Rair 106</p> <p>Ram 153</p> <p>Research Machines 185</p> <p>Riva 36</p> <p>S</p> <p>SBD 34, 214</p> <p>SDM 200</p> <p>Sentov 184</p> <p>Sharp 121, 255</p> <p>Shelton 139</p> <p>Sigma UK 264</p> <p>Sinclair 83, 97, 98, 99, 100</p> <p>Sirton 31</p> <p>Small Systems Engineering 210</p> <p>Software House 180</p> <p>SPD 225</p> <p>Spider 206</p> <p>Stage One 152</p> <p>STCS 251</p> <p>Sumlock Bondain 74, 184</p> <p>Supersoft 198</p> <p>IFC 232</p> <p>Swan Packaging 258</p> <p>Symbiotics 224</p> <p>Systems International 251</p> <p>Systemsoft 226</p> <p>T</p> <p>Tabis 130</p> <p>Technomatic 261</p> <p>Telesystems 230</p> <p>Terminal Systems Services 210</p> <p>Texas 118, 119</p> <p>Tex Microsystems 216, 228</p> <p>This Could Be Fun 250</p> <p>Tim Orr Design 246</p> <p>Traffic Technology 208</p> <p>Transtec 231</p> <p>Transam 237</p> <p>Tndata Micros 246</p> <p>Triumph Adler 211</p> <p>Twickenham Computer Centre 220</p> <p>U</p> <p>University of Manchester 218</p> <p>V</p> <p>Verbatim 137</p> <p>Visconti (Essential Software) 134</p> <p>Vision Business Systems 217</p> <p>Viasak 108</p> <p>W</p> <p>Watford Electronics 235</p> <p>Ward 242</p> <p>Westfarthing 226</p> <p>Wideband 198</p> <p>William Stuart Systems 222</p> <p>Willis 232</p> <p>Windfall 190</p> <p>Woodland Software 212</p> <p>X</p> <p>X-Data 69</p>
---	--	---	--

If you prefer the better things in life then you're going to like the new

Micro

8

Epson MX80 New Type 2 £465 + VAT



BMC 14" Green Screen
£180 + VAT

RGB Colour version available

Micro 8 (keyboard unit)
£995 + VAT

The Micro-8 is a new generation of microcomputer incorporating the very latest in technology. Based on the new 8 bit 6809 microprocessor (utilises 16 bit internal architecture and Micro-8 uses 2 of them!) along with its Z80 microprocessor (CP/M capability) and high resolution colour graphics the Micro-8 is ideal for all those discerning users, business, educational and hobbyist alike. Just look at all these STANDARD features which for most micros are expensive add on's or even just not available:-

**Utilises 2 x 6809 MPU *64k RAM *Comp Video & RGB output *High Resolution Colour Graphics 640 x 200 *48k Video RAM *Mixable high & low res. screens *Soft select 40 column or 80 column screen *10 user defined function keys *Duplex RS232 port *Parallel printer port *Real Time clock/interrupt timer *Comprehensive cursor and edit control keys *Graphics cursor Draw and plot with Cartesian card o/p *Z80 MPU.*

*Utilises 32k extended Microsoft Basic with all the standard commands plus the following:-
AUTO, RENUM, MERGE, TROFF, TRON, EXEC, HARDC, BUBINI, DEFFN, DEFUSR, DEFIN, IF-THEN-ELSE (Multiple), ON ERROR GOTO, RESUME, UNLIST, PAIN, CIRCLE, CONNECT, SYMBOL, GCURSOR, PRINTUSING, DSKs, BUBO, BUBI, KEYLIST, FIX, CSNG, POINT, VARPTR, TIMEs, DAT Es, DSKs, ANPORT, HEXs, FEFTs, OCTs, STRs, STRINGs, XOR IMP MOD, ON TIME GOSUB, IN INTERVAL GOSUB, CSNG, CDBL, CINT.*

Operating systems include:- UCSD PASCAL, FLEX, CP/M, running, Basic, Fortran, Pascal.

*Future expansions include:- *BUBBLE MEMORY *MODEM *SOUND SYNTH. and many more.*

Micro 8 Ltd.

56 Queens Road, Basingstoke, Hants.

Tel: 0256 54057/56417 (4 lines)

To: Micro 8 Ltd., 56 Queens Road, Basingstoke, Hampshire.
Please send me details of the amazing new Micro 8.

Name..... Company

Address

..... PC12

● Circle No. 423

Delta Configurable Systems

MP/M* Hard Disk



DP/NET



DELTA PRODUCTS' range of S-100 microcomputers

offer a flexible approach to your computing requirements. Systems are upgradable, so expansion can follow in step with the growth of your Company or requirements. You never purchase more system than you need or can afford.

Start with a 1 or 2 Mbyte floppy disk based system with 64 Kbytes of memory, a 4 MHz Z80A processor and the industry standard CP/M* operating system. As needs require expand to a multiuser, multitasking system supporting up to 8 users sharing 400 Kbytes of memory and 5-150 Mbytes of hard disk with serial tape backup running under the MP/M* operating

system.

There are few situations where up to 8 users could access a single processor and work in a satisfactory manner, generally more processors, are needed to share the work load. This is called "distributed processing". DELTA offer a distributed processing system with up to 20 users utilizing CP/NET.

A computer system to the end user is the SOFTWARE. We have an extensive catalogue of proven software products to offer a complete solution to your computing requirements.

Consider the possibilities. We did, together with the users of over 3000 DELTA systems now in the field.

* CP/M, MP/M and CP/NET are trademarks of Digital Research Inc.
Z80A is a trademark of Zilog Inc.



TERODEC

Terodec (Microsystems) Limited
Unit 58, Sutton's Park Avenue
Earley, Reading, Berkshire RG6 1AZ
Telephone: (0734) 664343

● Circle No. 424

“MAKING MICROCOMPUTERS FOR THE ‘80S”



Pictured is the SuperFAST™ CACHE BIOS System. For further information and a catalogue of our IEEE S100 products contact us today

Coleridge Lane, Coleridge Road,
London N8 8ED England
Telephone: 01-341 2447
Telex: 299568

ITHACA **InterSystems**™ (UK) Ltd.